

IZFI Condensing Unit

For Refrigeration Applications (7.5-20 HP) - Southeast Asia



Product catalogue

COPELAND[™]

EMERSON[™]

IZFI Condensing units for low temperature refrigeration applications

The IZFI scroll condensing unit platform has been developed specifically for low temperature refrigeration applications. It is designed with Emerson's highly efficient ZFI* KQE vapor injection scroll compressor, effectively delivering 45% higher efficiencies compared to any single-stage condensing unit available in the market today. The IZFI scroll condensing units are factory assembled and fully-featured using Emerson branded line components.

The units are equipped with CoreSense technology for protection and communication. CoreSense senses the discharge line temperature and regulates vapor injection to protect the condensing unit from overheating. LED display alerts the user of discharge line temperature sensor status and electronic expansion valve operation. Vapor injection regulation through CoreSense technology results in better condensing unit reliability at low temperature operation and higher system efficiencies.



Table of contents

Key features	04
Nomenclature	05
Bill of material	06
Layout	07
Operating envelopes	08
Performance data	09
Technical data	11
Dimensional drawings	12
Typical liquid line temperature	13
Contact lists	16

Key features

Vapor injection technology for 45% higher efficiency

- Vapor injection allows ZFI* KQE compressors to perform at higher efficiencies than single-stage compressors at low temperature operation.
- Vapor injection improves system capacity by 50% and efficiency by 45% on average.

Scroll efficiency and reliability

- COP improvement reduces energy consumption by up to 20%.
- 70% fewer moving parts than reciprocating.
- Superior liquid handling.

Smooth scroll movement

- Low sound and vibration leading to reliable & peaceful operation.
- No complex internal suction and discharge valves for quieter operation and higher reliability.

CoreSense™ for Copeland scroll compressors

- High discharge line temperature protection through onboard control for vapor injection.
- Direct communication function by using LED display alerts.
- Low temperature operation reliability due to vapor injection technology.

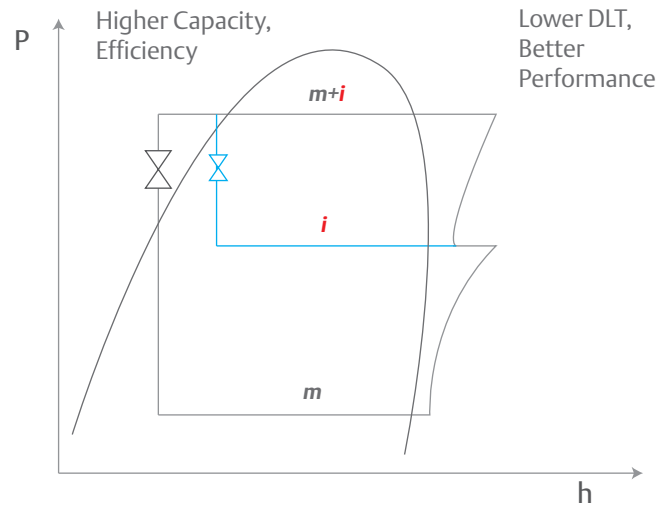

Wide range operating envelope

- Designed for low temperature operation.
- Designed for tropical ambient operation.

Save on applied costs and assembly time

- IZFI condensing units come fully assembled with full scope of supply (e.g. filter drier, sight glass, liquid line solenoid valve, electrical contactor).
- Emerson quality built condensing unit.

Nomenclature

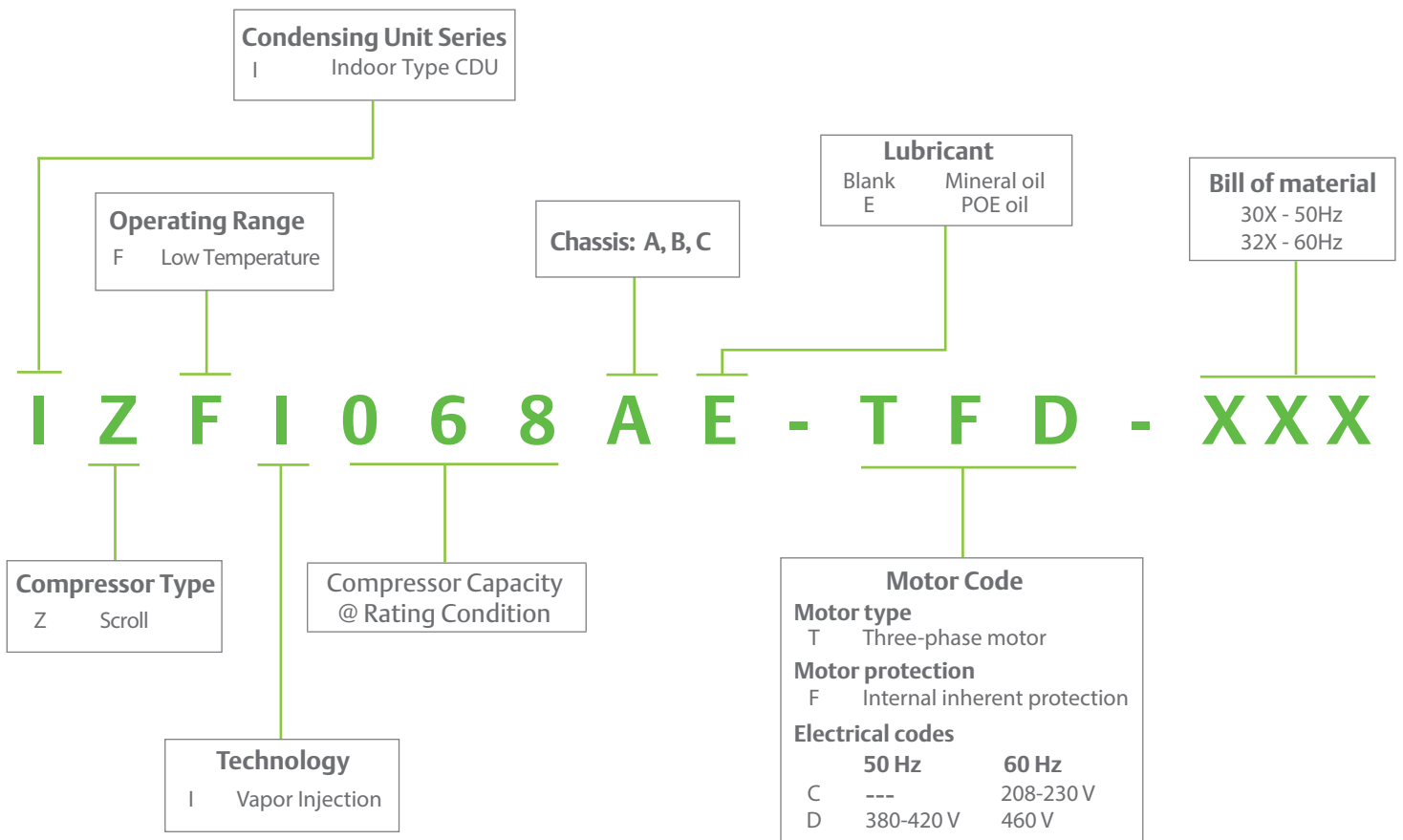

Bill of material

Standard features	300/320
Compressor - rotalock connection	✓
PHE/economizer	✓
Fan motor	✓
Receiver	✓
Accumulator	✓
Sight glass / moisture indicator	✓
Filter drier	✓
Adjustable dual pressure switch	✓
Oil separator	✓
Crankcase heater	✓
CoreSense™	✓
Compressor contactor	✓
Electrical box	✓

Layout

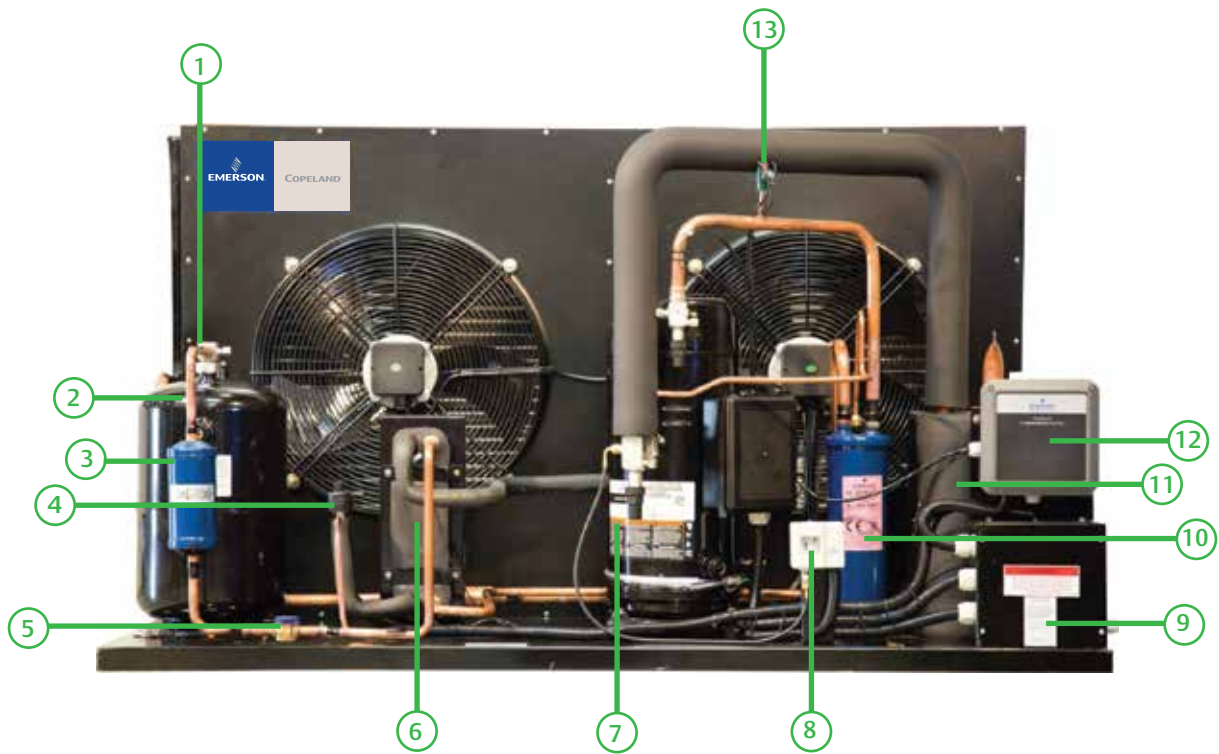

Item	Description	Item	Description
1	Rotalock connection with schraeder valve	8	¹ Adjustable LP switch
2	Receiver	9	Terminal box
3	Filter drier	10	Oil separator
4	EXV	11	Accumulator
5	Sight glass	12	CoreSense™
6	PHE / economizer	13	² Fixed HP cut out
7	ZFI Scroll compressor		

Note:

^{1,2}Adjustable LP switch and fixed HP cut out have been replaced with an adjustable dual pressure switch.

Operating envelopes

R404A

50Hz

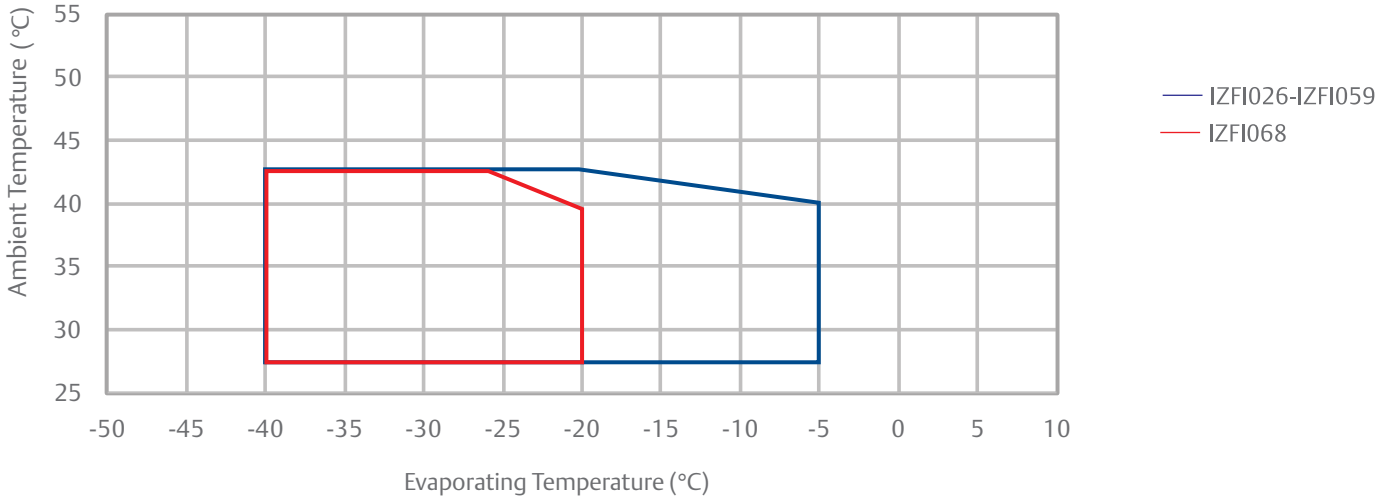

R404A

60Hz

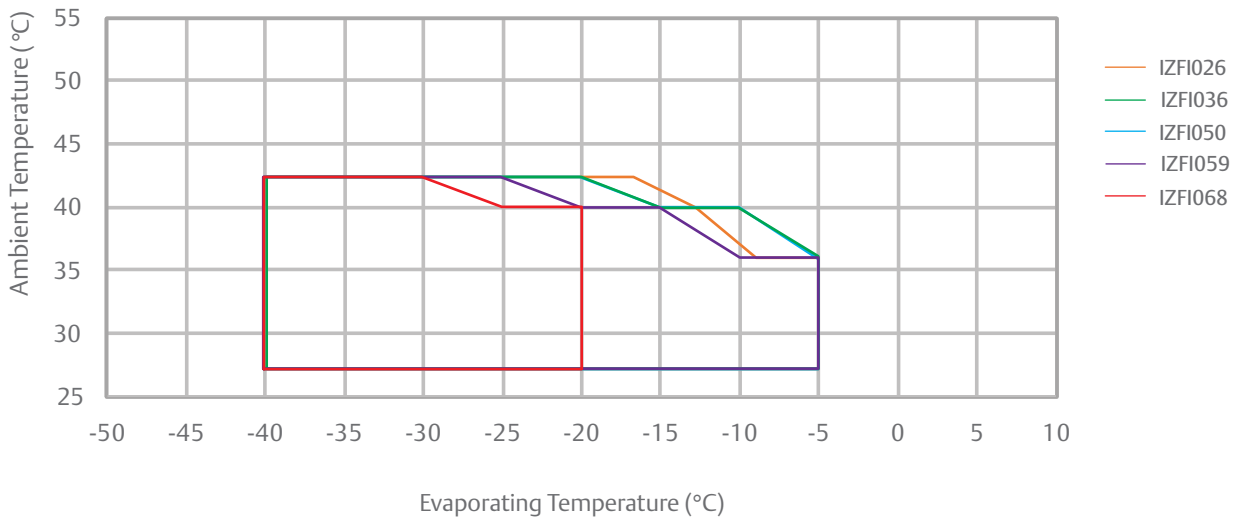

Performance data

R404A

50Hz

R-404A / 3 phase				Evaporating Temperature (°C)							
Model	Nominal HP		Ambient Temperature (°C)	-40	-35	-30	-25	-20	-15	-10	-5
IZFI026AE	7.5	Q	27	5.11	6.21	7.46	8.88	10.50	12.33	14.41	16.74
			32	5.09	6.13	7.31	8.67	10.23	12.01	14.02	16.28
			38	5.08	6.03	7.13	8.41	9.88	11.57	13.49	15.66
			43	5.08	5.95	6.96	8.17	9.56	11.17	13.01	15.09
		P	27	3.86	4.10	4.36	4.62	4.90	5.20	5.51	5.85
			32	4.20	4.48	4.76	5.06	5.37	5.70	6.05	6.42
			38	4.60	5.02	5.35	5.69	6.04	6.41	6.80	7.22
			43	5.20	5.57	5.94	6.33	6.72	7.13	7.57	8.03

IZFI036BE	10	Q	27	6.44	7.91	9.58	11.43	13.44	15.61	17.94	20.42
			32	6.33	7.74	9.33	11.11	13.04	15.13	17.39	19.76
			38	6.25	7.55	9.04	10.70	12.53	14.52	16.64	18.92
			43	6.23	7.43	8.81	10.37	12.09	13.97	16.00	18.14
		P	27	4.61	4.95	5.29	5.63	5.98	6.32	6.68	7.03
			32	4.95	5.36	5.76	6.15	6.53	6.92	7.29	7.66
			38	5.38	5.89	6.37	6.84	7.29	7.73	8.14	8.55
			43	5.76	6.36	6.93	7.47	7.98	8.48	8.96	9.40

IZFI050CE	15	Q	27	9.02	10.64	12.74	15.24	18.06	21.14	24.37	27.70
			32	8.79	10.37	12.42	14.85	17.59	20.55	23.68	26.85
			38	8.45	10.01	12.00	14.35	16.98	19.84	22.80	25.83
			43	8.12	9.66	11.61	13.89	16.45	19.20	-	-
		P	27	6.07	6.54	7.01	7.48	7.96	8.49	9.04	9.66
			32	6.59	7.09	7.60	8.11	8.64	9.20	9.81	10.46
			38	7.29	7.84	8.39	8.95	9.53	10.15	10.80	11.52
			43	7.95	8.53	9.12	9.73	10.36	11.02	-	-

IZFI059CE	18	Q	27	10.92	12.87	15.40	18.39	21.76	25.40	29.23	33.13
			32	10.62	12.53	15.00	17.90	21.16	24.69	28.35	32.09
			38	10.19	12.07	14.47	17.28	20.42	23.78	27.27	30.79
			43	9.78	11.63	13.97	16.71	19.74	-	-	-
		P	27	7.37	7.97	8.59	9.22	9.87	10.57	11.34	12.19
			32	8.03	8.67	9.34	10.02	10.73	11.49	12.31	13.22
			38	8.91	9.61	10.34	11.09	11.88	12.70	13.59	14.55
			43	9.73	10.49	11.27	12.09	12.92	-	-	-

IZFI068CE	20	Q	27	12.32	14.53	17.36	20.71	24.47	-	-	-
			32	11.98	14.13	16.89	20.14	23.78	-	-	-
			38	11.48	13.58	16.26	19.41	22.90	-	-	-
			43	10.99	13.08	15.69	-	-	-	-	-
		P	27	8.58	9.31	10.07	10.85	11.67	-	-	-
			32	9.36	10.14	10.96	11.81	12.71	-	-	-
			38	10.41	11.27	12.16	13.10	14.08	-	-	-
			43	11.40	12.33	13.28	-	-	-	-	-

Q: Cooling Capacity (kW), P: Total Power Input (kW), Return Gas Temperature: 18.30 °C

Performance data

R404A

60Hz

R-404A / 3 phase				Evaporating Temperature (°C)							
Model	Nominal HP		Ambient Temperature (°C)	-40	-35	-30	-25	-20	-15	-10	-5
IZFI026AE	7.5	Q	27	6.20	7.64	9.20	10.91	12.79	14.86	17.13	19.64
			32	6.06	7.45	8.96	10.59	12.39	14.35	16.51	18.88
			38	5.84	7.18	8.60	10.14	11.82	13.65	15.67	17.88
			43	5.61	6.89	8.23	9.69	11.26	12.98	14.87	-
		P	27	4.83	5.20	5.59	6.01	6.46	6.93	7.44	8.00
			32	5.19	5.62	6.07	6.53	7.02	7.53	8.08	8.67
			38	5.72	6.24	6.75	7.29	7.84	8.41	9.01	9.66
			43	6.28	6.87	7.46	8.06	8.67	9.31	9.98	-

IZFI036BE	10	Q	27	7.65	9.42	11.32	13.46	15.91	18.71	21.96	25.71
			32	7.55	9.19	11.00	13.03	15.36	18.07	21.21	24.82
			38	7.54	9.02	10.66	12.53	14.70	17.23	20.20	23.64
			43	7.68	8.98	10.45	12.15	14.17	16.53	-	-
		P	27	6.08	6.57	7.02	7.47	7.96	8.53	9.20	10.04
			32	6.49	7.03	7.54	8.06	8.61	9.25	10.00	10.90
			38	7.04	7.67	8.25	8.85	9.47	10.18	11.02	12.01
			43	7.60	8.27	8.92	9.57	10.27	11.04	-	-

IZFI050CE	15	Q	27	10.64	12.55	15.02	17.95	21.27	24.85	28.61	32.48
			32	10.36	12.24	14.64	17.50	20.70	24.15	27.79	31.47
			38	9.95	11.79	14.13	16.88	19.97	23.28	26.75	30.23
			43	9.56	11.38	13.67	16.34	19.33	-	-	-
		P	27	7.75	8.32	8.90	9.48	10.09	10.74	11.44	12.22
			32	8.38	8.99	9.61	10.25	10.91	11.60	12.36	13.18
			38	9.22	9.89	10.56	11.26	11.98	12.74	13.57	14.45
			43	10.00	10.73	11.46	12.20	12.98	-	-	-

IZFI059CE	18	Q	27	13.09	15.44	18.44	21.99	26.00	30.30	34.78	39.35
			32	12.72	15.01	17.95	21.41	25.27	29.42	33.72	38.05
			38	12.19	14.44	17.29	20.63	24.35	28.32	-	-
			43	11.68	13.89	16.68	19.93	-	-	-	-
		P	27	9.51	10.27	11.04	11.85	12.71	13.63	14.62	15.73
			32	10.31	11.13	11.98	12.85	13.78	14.77	15.83	17.00
			38	11.39	12.29	13.22	14.18	15.20	16.28	-	-
			43	12.41	13.37	14.37	15.42	-	-	-	-

IZFI068CE	20	Q	27	14.72	17.34	20.69	24.65	29.08	-	-	-
			32	14.28	16.84	20.13	23.95	28.24	-	-	-
			38	13.66	16.17	19.35	23.05	27.17	-	-	-
			43	13.06	15.53	18.63	-	-	-	-	-
		P	27	10.98	11.90	12.85	13.86	14.93	-	-	-
			32	11.93	12.93	13.98	15.05	16.22	-	-	-
			38	13.23	14.32	15.47	16.66	17.94	-	-	-
			43	14.44	15.62	16.85	-	-	-	-	-

Q: Cooling Capacity (kW), P: Total Power Input (kW), Return Gas Temperature: 18.30 °C

Technical data

Model Name		Vapor Injection				
		IZFI026AE	IZFI036BE	IZFI050CE	IZFI059CE	IZFI068CE
Compressor Model		ZFI26KQE	ZFI36KQE	ZFI50KQE	ZFI59KQE	ZFI68KQE
Motor Code	50Hz	TFD	TFD	TFD	TFD	TFD
	60Hz	TFD/TFC	TFD/TFC	TFD/TFC	TFD/TFC	TFD/TFC
Receiver (Liters)		12	18	21	21	21
No. of Fans/ Fan Motor Power		2/470W	2/800W	2/800W	2/800W	2/800W
Air Flow in m ³ /hr	50Hz	4111	6300	7500	7500	7500
	60Hz	4111	6300	7400	7400	7400
Return Gas Line Size (in)		1 1/8	1 3/8	1 5/8	1 5/8	1 5/8
Liquid Line Size (in)		1/2	1/2	5/8	5/8	5/8
Voltage	50Hz	380-420				
	60Hz	460/208-230				
Locked Rotor Amperes	50Hz	74	102	118	118	139
	60Hz	75/156	99/224	125/239	125/248	139/338.7
Rated Load Amperes	50Hz	12.3	14.6	21.7	23.0	20.2
	60Hz	12.3/23.9	14.6/31.3	21.7/41.2	23.0/49.5	20.2/57.1
Maximum Operating Current	50Hz	13.7	16.0	25.0	29.0	30.0
	60Hz	13.7/26.0	16.0/36.7	25.0/51.4	29.0/57.7	30.0/67.9
Net Weight (kg Including Oil)		126	141	247	247	250
Oil Type		POE				

Dimensional drawings

Front View

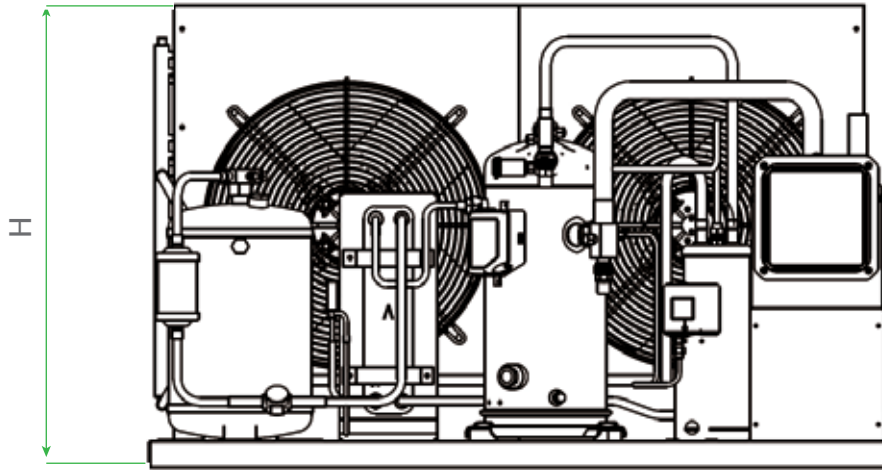

Top View

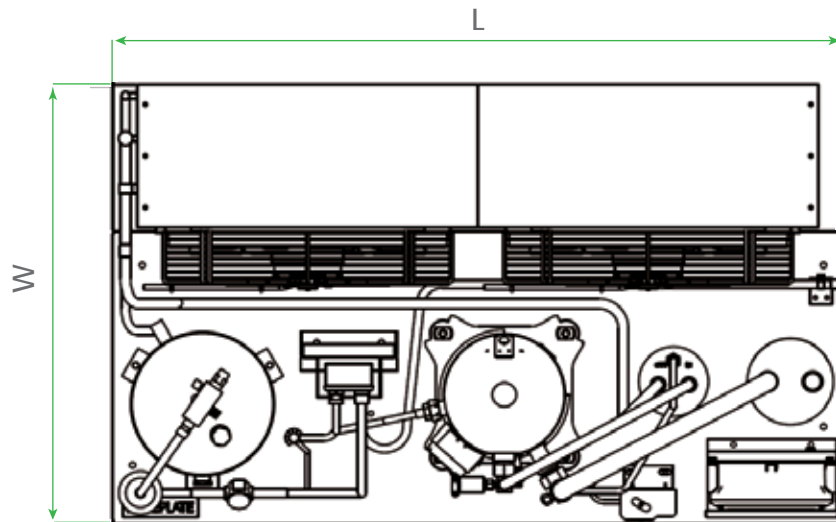

	IZFI026AE	IZFI036BE	IZFI050CE	IZFI059CE	IZFI068CE
Chassis Size (LxWxH)cm	113 x 68 x 70	133 x 82 x 83	164 x 82 x 95	164 x 82 x 95	164 x 82 x 95

Typical liquid line temperature

R404A

Evaporating Temperature (°C)	Ambient Temperature (°C)			
	27	32	38	43
-40	-17.1	-14.6	-11.9	-9.2
-35	-12.8	-10.2	-7.4	-4.7
-30	-8.4	-5.7	-3.0	-0.2
-25	-4.0	-1.2	-1.6	-4.3
-20	0.6	3.3	6.0	8.6
-15	6.7	8.8	11.4	14.1
-10	10.7	12.6	14.9	17.3
-5	14.4	16.0	17.9	---

Note: Liquid line temperatures in the above table should be used for expansion valve sizing.



General information

Technical data are correct at the time of printing. Updates may occur, and should you need confirmation of a specific value, please contact Emerson clearly stating the information required.

Emerson cannot be held responsible for errors in capacities, dimensions, etc., stated herein. Products, specifications and data in this literature are subject to change without notice.

The information given herein is based on data and tests which Emerson believes to be reliable and which are in accordance with today's technical knowledge. It is intended for use by persons having the appropriate technical knowledge and skill, at their own discretion and risk. Our products are designed and adapted for fixed locations. For mobile applications, failures may occur.

The suitability for this has to be assured from the plant manufacturer, which may include making appropriate tests.

Note:

The components listed in this catalogue are not released for use with caustic, poisonous or flammable substances. Emerson cannot be held responsible for any damage caused by using these substances.

About Emerson

Emerson (NYSE: EMR), headquartered in St. Louis, Missouri (USA), is a global technology and engineering company providing innovative solutions for customers in industrial, commercial, and residential markets. Our Emerson Automation Solutions business helps process, hybrid, and discrete manufacturers maximize production, protect personnel and the environment while optimizing their energy and operating costs. Our Emerson Commercial and Residential Solutions business helps ensure human comfort and health, protect food quality and safety, advance energy efficiency, and create sustainable infrastructure. For more information visit [Emerson.com](https://www.emerson.com).

Contact lists

Emerson Commercial & Residential Solutions

Asia Pacific Headquarters

Emerson Climate Technologies
Suite No. 2503-8, 25/F,
Exchange Tower, 33 Wang Chiu Road,
Kowloon Bay, Kowloon, Hong Kong
Tel: (852) 2866 3108
Fax: (852) 2520 6227

Australia

Emerson Climate Technologies
Australia Pty Ltd
356 Chisholm Road
Auburn NSW 2144, Australia
Tel: (612) 9795 2800
Fax: (612) 9738 1699

China - Beijing

Emerson Climate Technologies
(Suzhou) Co. Ltd
Beijing Sales Office
Room 1017 JianWei Building,
66 Nan Lishi Road, XiCheng District,
Beijing, PRC
Tel: (8610) 5763 0488
Fax: (8610) 5763 0499

China - Guangzhou

Emerson Climate Technologies
(Suzhou) Co. Ltd
Guangzhou Sales Office
508-509 R&F Yinglong Plaza,
No. 76 Huangpu Road West,
Guangzhou, PRC
Tel: (8620) 2886 7668
Fax: (8620) 2886 7622

China - Shanghai

Emerson Climate Technologies
(Suzhou) Co. Ltd
Shanghai Sales Office
7F, Emerson Building, 1582 Gumei
Rd, Shanghai, PRC
Tel: (8621) 3338 7333

India - Mumbai

Emerson Climate Technologies (India) Ltd
Delphi B-Wing, 601-602, 6th Floor
Central Avenue, Hiranandani Business Park,
Powai, Mumbai 400076
Tel: (9122) 6786 0793
Fax: (9122) 6662 0500

India - Pune

Emerson Climate Technologies (India) Ltd
Plot No. 23, Rajiv Gandhi Infotech Park,
Phase - II, Hinjewadi,
Pune 411 057, Maharashtra, India
Tel: (9120) 4200 2000
Fax: (9120) 4200 2099

Indonesia

PT Emerson Indonesia
BSD Taman Tekno 8
Jl. Tekno Widya Blok H10 No 2 & 3
Tangerang Selatan 15314
Indonesia
Tel: (6221) 2966 6242
Fax: (6221) 2966 6245

Japan

Emerson Japan Ltd
Shin-yokohama Tosho Building
No. 3-9-5 Shin-Yokohama, Kohoku-ku
Yokohama 222-0033 Japan
Tel: (8145) 475 6371
Fax: (8145) 475 3565

Malaysia

Emerson Electric (Malaysia) Sdn. Bhd.
Level M2, Blk A, Menara PKNS-PJ
Jalan Yong Shook Lin
46050 Petaling Jaya, Selangor, Malaysia
Tel: (603) 7949 9222
Fax: (603) 7949 9333

Middle East & Africa

Emerson Climate Technologies
PO Box 26382
Jebel Ali Free Zone – South
Dubai, UAE
Tel: (9714) 811 8100
Fax: (9714) 886 5465

Philippines

Emerson Climate Technologies
10/F SM Cyber West Avenue, EDSA cor. West
Avenue, Barangay Bungad, Diliman, Quezon
City 1105 Philippines
Tel: (632) 689 7200

Saudi Arabia

Emerson Arabia Inc.
P.O Box 34332 – 3620 Building 7874
Unit 1, 67th street 2nd Industrial City
Dammam, Saudi Arabia
Toll Free: 8008443426
Tel: + 966 3 8147560
Fax: + 966 3 8147570

South Korea

Emerson Electric Korea Ltd.
3F POBA Gangnam Tower
343, Hakdong-ro, Gangnam-gu,
Seoul 135-820, Republic of Korea
Tel: (822) 3483 1500
Fax: (822) 592 7883

Taiwan

Emerson Electric (Taiwan) Co. Ltd
3F No. 122 Lane 235,
Pao Chiau Rd., XinDian Dist.,
New Taipei City 23145, Taiwan (R.O.C.)
Tel: (8862) 8912 1360
Fax: (8862) 8912 1890

Thailand - Bangkok

Emerson Electric (Thailand) Ltd
34th Floor, Interlink Tower,
1858/133, Bangna Trad,
Bangkok 10260, Thailand
Tel: (662) 716 4700
Fax: (662) 751 4241

United Arab Emirates

Emerson Climate Technologies FZE
Jebel Ali Free Zone
PO Box 26382
Dubai UAE
Toll Free: 8004413428
Tel: + 971 4 8118100
Fax: + 971 4 8865465

Vietnam

Emerson Commercial & Residential Solutions
Level 6, Melinh Point Tower, 2 Ngo Due Ke,
District 1, Ho Chi Minh City
Vietnam
Tel: (84) 908 009 189

EmersonClimateAsia.com

Asia 02 A0103 - R00 Issued 03/2017

Emerson, Copeland PerformanceAlert, CoreSense and Copeland Scroll are trademarks of Emerson Electric Co. or one of its affiliated companies. ©2017 Emerson Climate Technologies, Inc. All rights reserved.

EMERSON. CONSIDER IT SOLVED.™