



N-8000 Series IP Intercom System





A versatile, highly reliable user needs for flexible,



TOA's unique N-8000 IP Intercom System is an integrated audio communication system that employs packet audio technology over the IP network to achieve fast, accurate communications with optimal security and reliability. Applications range from conversation, paging broadcasting and BGM broadcasting to emergency paging and broadcasting, audio triggering and other security functions. Users can select between two communication modes according to their needs: Master-to-Master station communication for duplex conversation at factories, hospitals and various other facilities; or Master-to-Sub station communication for use by institutions such as schools or prisons. The system frequency response extends to 7 kHz, enabling reliable transmission of a full range of emergency communications, including clear, easily understandable PA announcements.

The N-8000 System's impressive scalability enables users to configure an intercom system that satisfies their precise requirements, from a small system with just two stations to a large, complex system with up to 192 components and 3,072 stations. Its open architecture permits flexible interfacing with other systems, moreover, reducing costs by enabling users to upgrade and expand their intercom system without replacing currently installed equipment, such as surveillance cameras, telephones and access controls. Since the N-8000 System is not server based, users can use dedicated TOA software to manage settings and centralized control on a PC and to conduct real-time monitoring of system operation and line status using an Internet browser.

iable IP intercom system designed to meet , cost-effective configuration and operation

System Features

- System configuration by LAN with intuitive software
- Master-to-Master and Master-to-Sub station communication
- Choice of four wiring configurations: CAT5, 2-core shielded cables, 2 wires or 4 wires
- Integration with access control, voice alarm, CCTV and other such systems
- Time correction
- Operation and stream logs
- System diagnosis

Basic Communication Features

Handset or hands-free conversation, Recall, Redial, Camp on busy, Mic-Off, Remote response, Single-digit dialing, Call transfer, Comprehensive call-forwarding features, Three-party conferencing

System scalability

The cost-effective N-8000 System can be configured to a scale that meets users' specific requirements, however small or large. As few as two stations can be linked in a small system, or up to 192 components can be interconnected to operate as many as 3,072 stations.

Borderless communications

Since the N-8000 System is IP network-compatible, it supports linkage between local areas and other locations worldwide. Centralized PC control with dedicated TOA software enables connection of all exchanges, IP stations and interface units with LAN, WAN and optical fiber networks.

Integrated communications and safety and features

Efficient centralized control integrates various systems to handle communications ranging from duplex conversations between stations to paging broadcasts, scheduled broadcasts and BGM broadcasting. The N-8000 System also provides master control for connection to users' pre-existing intercom, alarm, surveillance, door entry/departure authorization and other systems as well as to telephone lines.

Easy installation and maintenance

The surprisingly easy system installation requires a minimum of on-site work, since existing wiring can be used and new components simply plugged in. The dedicated TOA software includes a maintenance application for system status monitoring, troubleshooting and logging as well as for system updating and remote control.

Long-term cost-effectiveness

Since N-8000 software and all calls between stations are free of charge, users enjoy the benefit of significantly lower telephone bills. Overall ownership costs are also reduced by the open-ended system architecture and network scalability permitting individualized configuration.

Superior sound quality

The N-8000 system provides high-quality audio for BGM, paging and recording applications.

Full logging options

The complete menu of operation and stream logging options includes operation verification, voice communications and line supervision logs, all of which can be archived easily for instant recall.

Internal and external system security

The N-8000 System is equipped with both a round-the-clock internal surveillance function to minimize downtime and a proprietary packet audio protocol to prevent wiretapping.

N-8000 System Overview

Direct Network Connection



2-Wire Connection

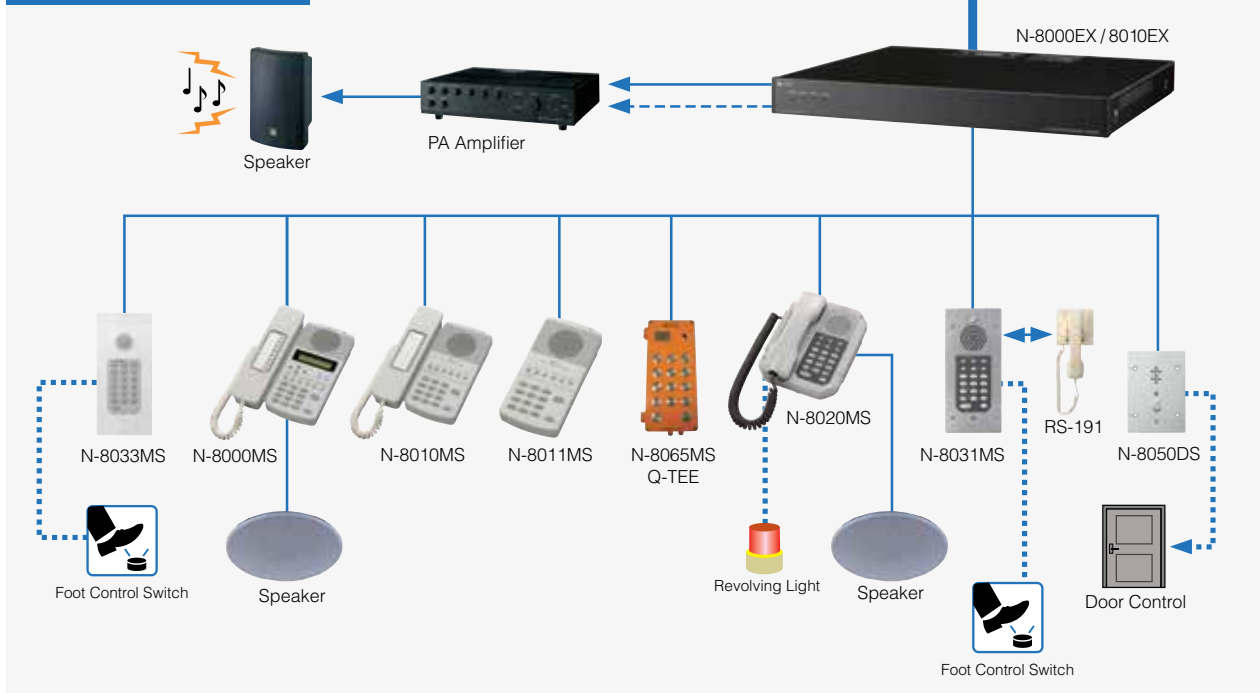

System Specifications

LAN Connections

Max. 192 units (total no. of Exchanges, Interface Units and IP stations)

Station Connections

Max. 3,072 stations (16 stations connected to each of 192 Exchanges)

Voice Links

Max. 768 links (4 links for each of 192 connected N-8000EX Exchanges)

Paging

Zones

Max. 192 zones

Paging Outputs

Max. 384 outputs (2 outputs for each of 192 connected N-8000 Exchanges or Multi-Interface units)

BGM

Max. 8 channels (number of channels selectable from a station)

PBX Interface

Max. 384 units (2 units for each of 192 connected Multi-Interface units)

Tie-Line Interface

Max. 384 units (2 units for each of 192 connected Multi-Interface units)

Outside-Line Interface

Max. 192 units

Telephone Interface

Max. 192 units (when 192 Telephone Interface units are connected)

External Contact Output

N-8000MI

Max. 3,072 (16 outputs for each of 192 connected Multi-Interface units)

N-8000DI

Max. 6,144 (32 outputs for each of 192 connected Direct Select units)

N-8000AF

Max. 1,536 (8 outputs for each of 192 connected Audio Interface units)

External Contact Input

N-8000MI

Max. 3,072 (16 inputs for each of 192 connected Multi-Interface units)

N-8000DI

Max. 6,144 (32 inputs for each of 192 connected Direct Select units)

N-8000AF

Max. 1,536 (8 inputs for each of 192 connected Audio Interface units)

[Network Relations]

Audio Delay Time

80 ms/320 ms; changeable

Connection Delay Time

Max. 1 second (when 191 multicast paging destinations are set)

Bandwidth Used

Max. 2.08 Mbps (one-way)/unicast paging to 16 locations

Max. 130 Kbps (two-way)/per call

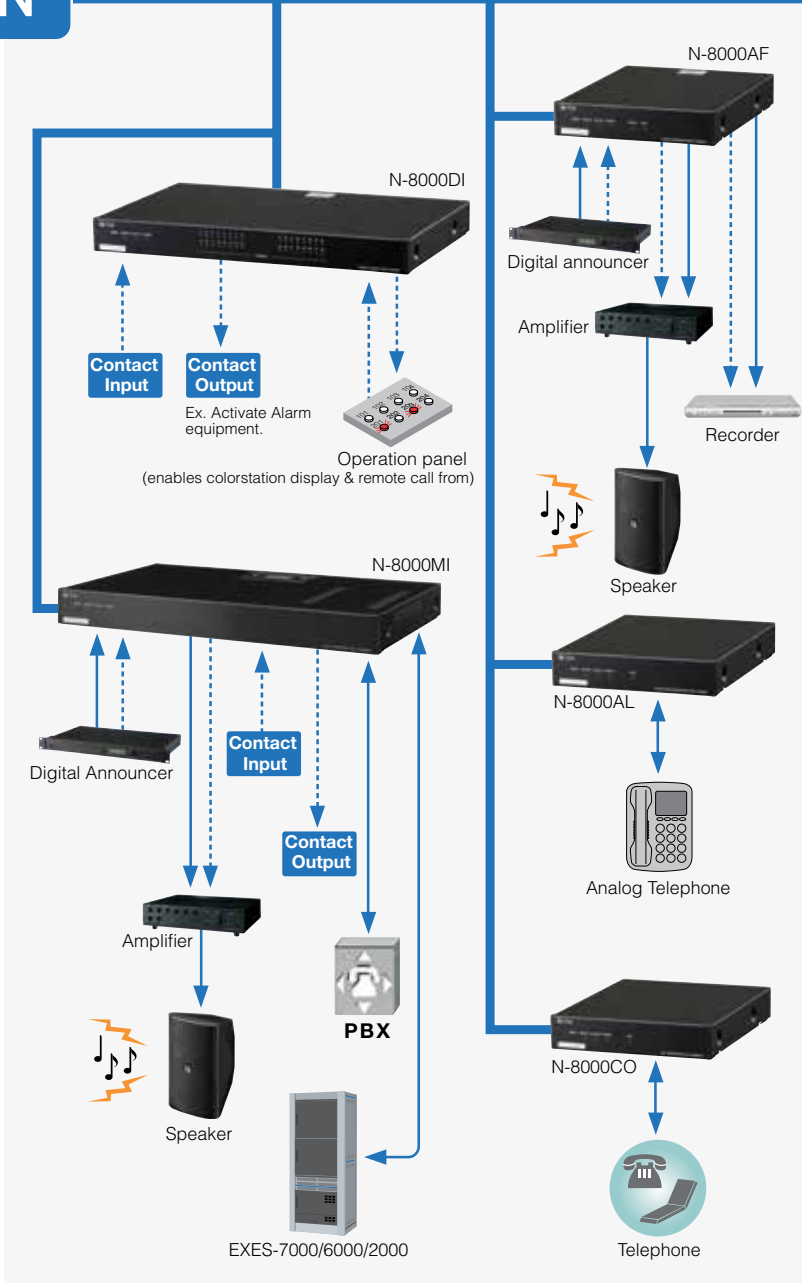

4-Wire Connection

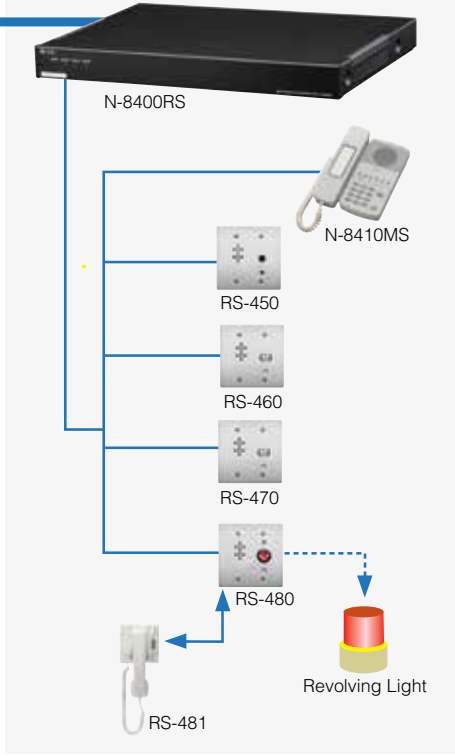

2-Core Shielded Wire Connection

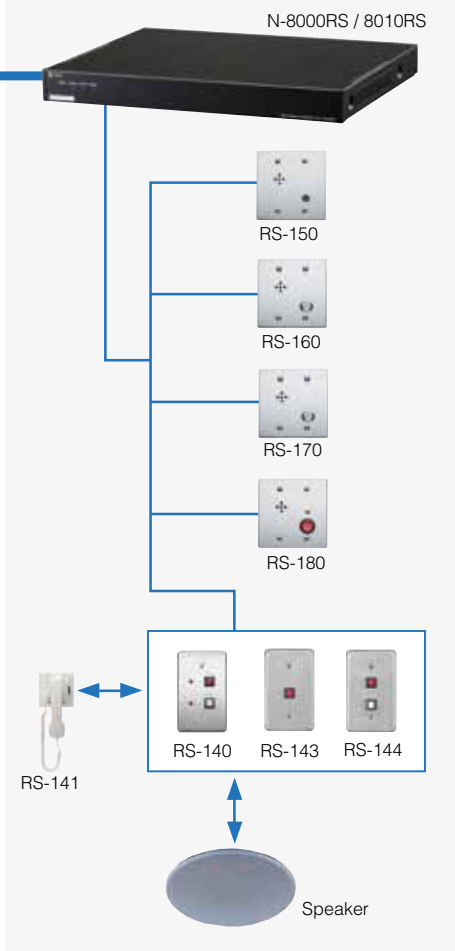

Permits the creation of a wide variety of system configurations through the free combination of individual interface units

- PBX Connection • Office line connection
- Tie-line connection • BGM
- External equipment control
- Remote door control • Conversation recording
- External input broadcast • Paging
- Paging interlock contact output control
- Call station indicator • CCTV interlock
- Remote dialing • Direct select
- Contact bridge • System diagnosis
- Time signal • Time correction

A variety of convenient functions

- Voice calling
- Hands-free conversation
- Automatic connection
- Continuous call
- One-touch dialing
- Call hold
- Automatic call forwarding
- Busy call
- Emergency call interruption
- Paging call
- Emergency all-group paging
- Emergency message broadcasts
- Paging response
- Scan monitor
- Three-party conference
- Door remote
- Emergency paging
- Audio trigger

Application Examples

Hospital

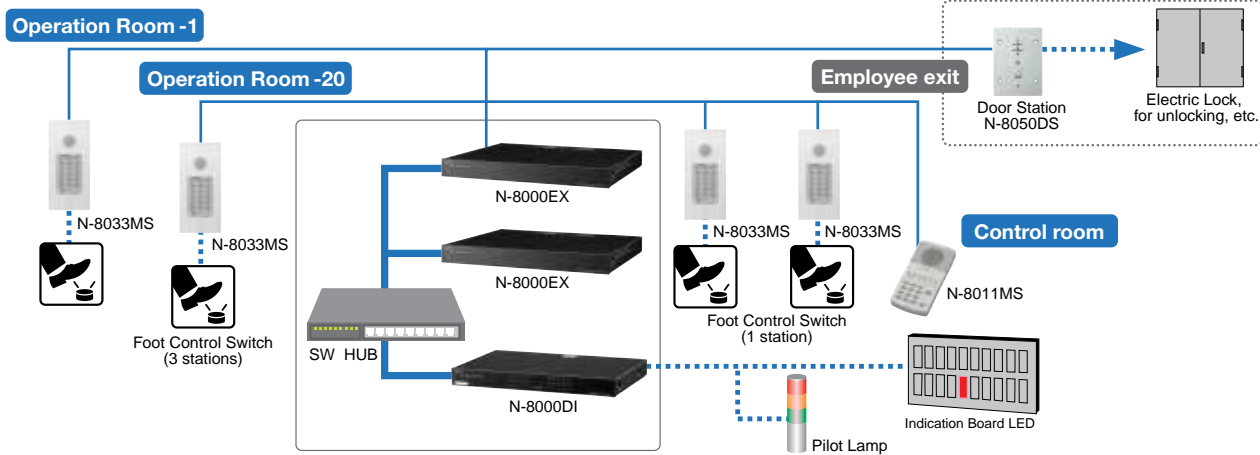

School

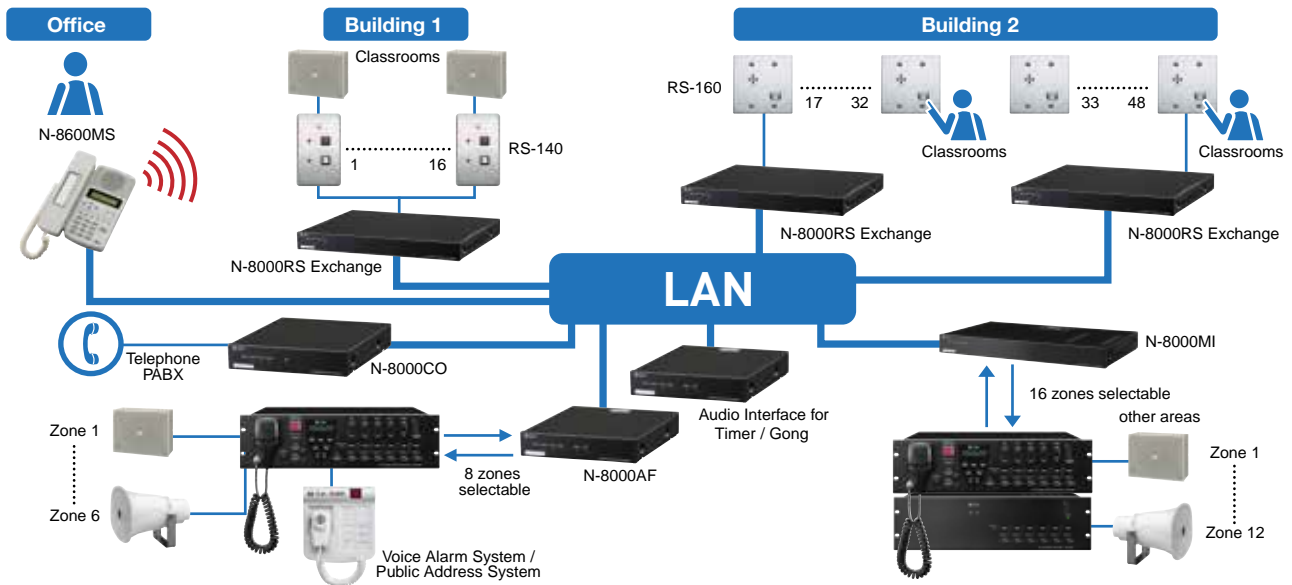

Factory

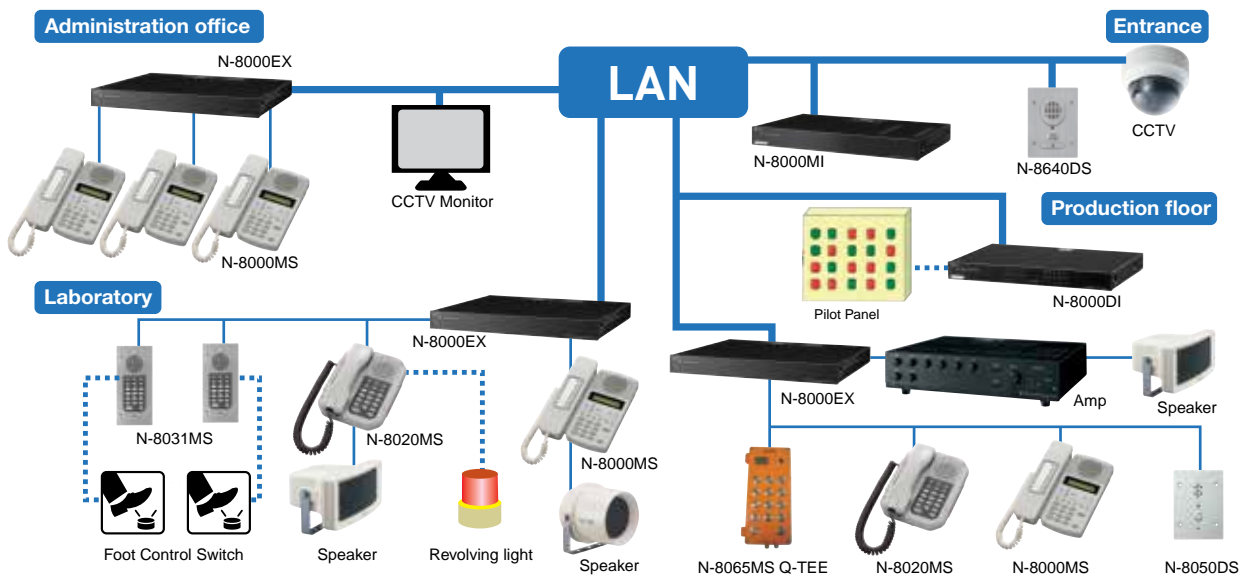

Parking garage

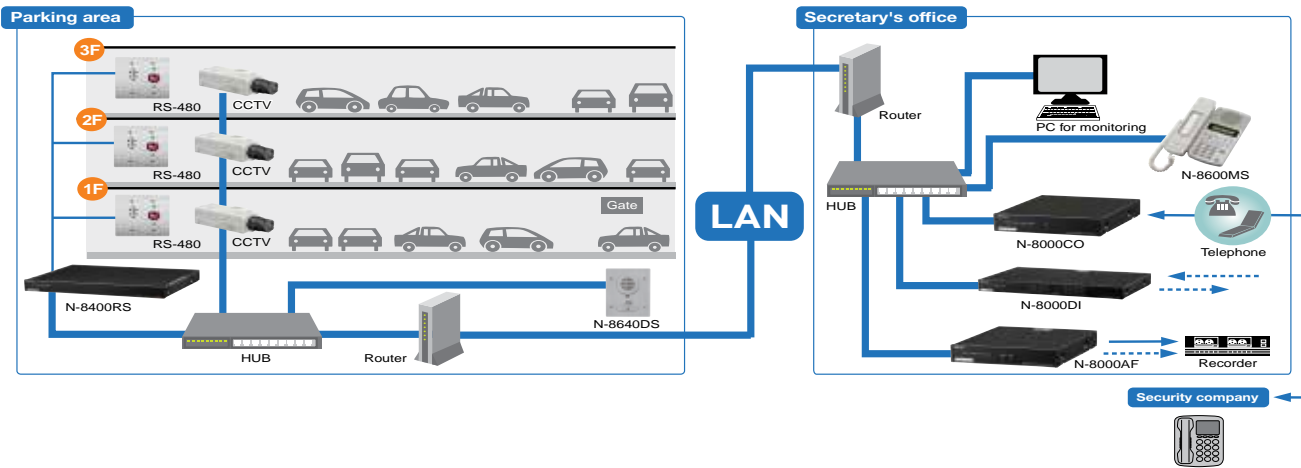

Large-scale communication & Paging system at Airport

Integration of N-8000 with SX-2000 Audio Management System strengthens system capabilities. A large system with up to 2048 zones is realized on the IP Network. From a remote location, IP Station* can make a paging call to any selected zone(s).

*N-8610RM and N-8600MS.

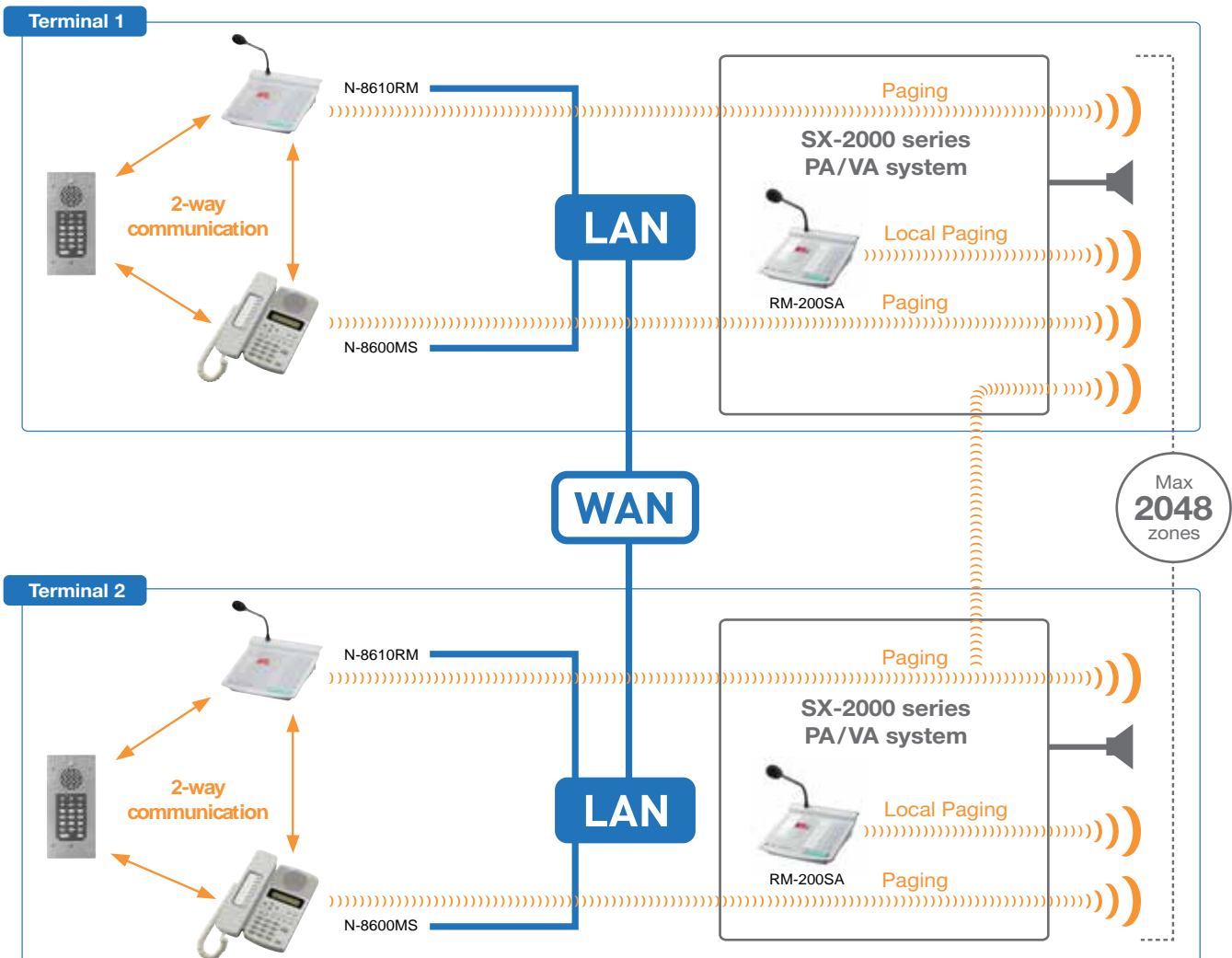

Station Selection Chart

		Desk-top	Optional Bracket	Wall-mount	Applicable Exchanges/ Interfaces
IP Base	Master/Door Stations	N-8610RM	WB-200RM	N-8640DS	
		N-8600MS	YC-280	N-8640SB N-8650DS	
2-Wire Type	Master/Door Stations	N-8000MS	YC-280	N-8050DS	N-8000EX
		N-8010MS	YC-280	N-8031MS	
		N-8011MS	YC-290	N-8033MS	
		N-8020MS	YC-280	N-8050SB N-8031SB	
2-core Shielded Type	RS Sub-stations			<div style="border: 1px solid black; padding: 5px;"> Vandal-resistant type <div style="border: 1px solid orange; padding: 5px; display: inline-block;"> Outdoor type RS-170 RS-180 RS-470 RS-480 </div> </div>	N-8000RS N-8010RS
				RS-150 RS-140 RS-142 RS-144 RS-143 RS-460 RS-470 RS-480	N-8400RS
4-wire Type		N-8410MS	YC-280		

Key Functions

Remote Control of External System Makes it possible to execute door lock control easily through a contact output when the master station is engaged in ongoing conversation with the N-8640DS or N-8050DS Door Station.

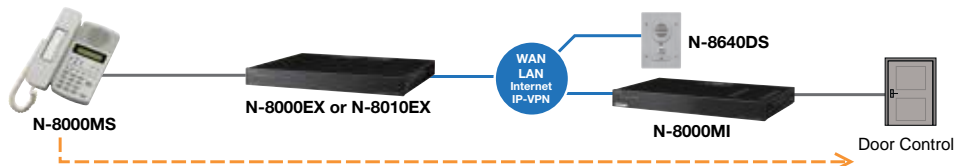

Key Functions

Paging Function Allows the master station as well as external input equipment to initiate paging by PA equipment or the speakers of individual stations. Operators can use the setup software to configure up to 192 paging zones to which paging calls can be made as desired.

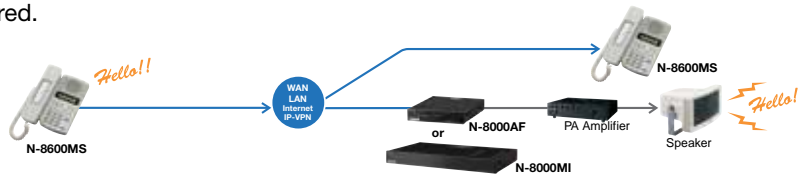

Privacy Mode Activated by a control on the RS-140 Switch Panel, blocks paging calls to connected speakers and prevents scan monitoring except for emergency calls.

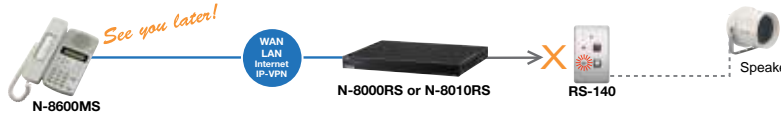

Direct Select Configures an operation panel equipped with indicator lamps and control buttons for the master station. Compatible with other stations, the panel assigns the various contact input and output channels to the master station and substations for purposes of identifying which substation is calling the programmed master station.

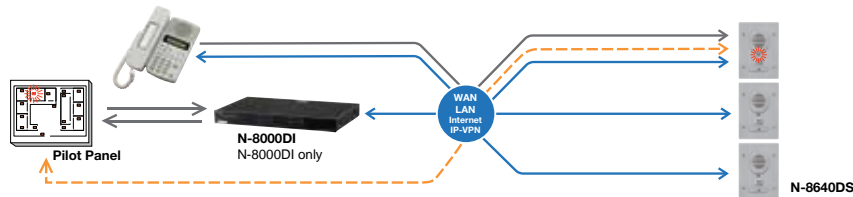

Scan Monitor Enables remote security monitoring by allowing the master station as well as analog telephones and external telephones to audio monitor two or more pre-programmed stations.

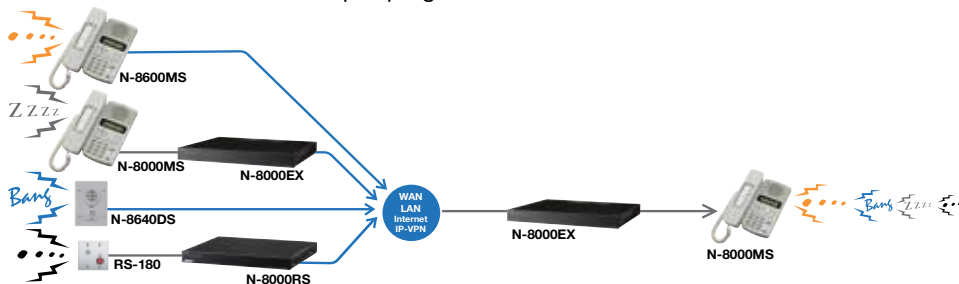

BGM Broadcasting Enables music from any of eight BGM sources connected to the N-8000MI to be distributed through speakers at the master and door stations.

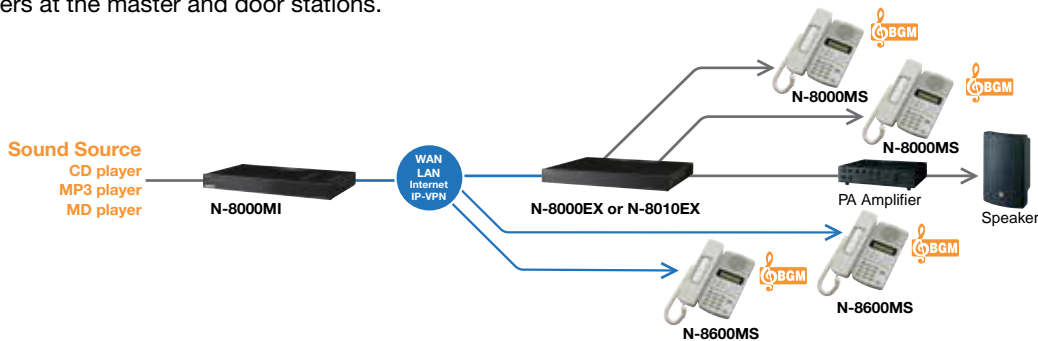

Audio Trigger Sets off an alarm if audio input to a pre-programmed station's microphone fulfils pre-set conditions (detection time or signal level). Examples include calls to the designated master station or contact output generated by another interface unit.

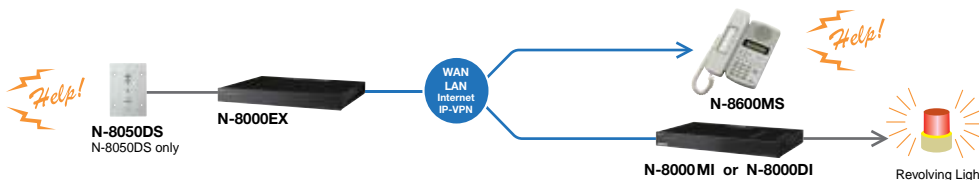

Specifications

IP Base Station

IP Multifunctional Master Station



IP Remote Microphone Station



	N-8600MS	N-8610RM
Power Source	Power supply device that complies with IEEE802.3af standard or 12V DC (supplied from the AC adapter (option))	
Power Consumption	3 W (max.)	Use of the AC adapter (12 V DC): 4W (microphone only), 8.5W (when connecting 4 RM-210 Extension units) Use of the PoE (48 V DC): 5.2W (microphone only), 7.5W (when connecting 4 RM-210 Extension units)
Speech Method	Hands-free or handset conversation	Hands-free conversation (use of goose-neck microphone)
Audio Frequency Range	300 Hz – 7 kHz	
External Speaker Terminal	Maximum output 0.5W, 8Ω, screwless connector (2P)	-
No. of Connectable Expansion	-	Max.4 units (maximum 2 units at PoE power supply)
Network Section		
Network I/F	10BASE-T/100BASE-TX (Automatic-Negotiation)	
Network Protocol	TCP/IP, UDP, ARP, ICMP, HTTP, RTP, IGMP	
Audio Packet Transmission System	Unicast, Multicast	
Voice Packet Loss Recovery	Silence insertion	
Audio Delay Time	80ms, 320ms (controllable on the software)	
Finish	Body, Handset: ABS resin, gray	ABS resin, blueishgray
Dimensions	148 (W) x 208 (H) x 70.5 (D)mm (excluding a curl cord section)	190 (W) x 76.5 (H) x 215 (D)mm (excluding microphone)
Weight	770 g	700 g
Options	Wall mounting bracket: YC-280, AC adapter: AD-1210P, AD-1215P	Remote microphone extension: RM-210 Wall mounting bracket: WB-RM200, AC adapter, AD-1210P, AD-1215P

0 dB= 1 V

IP Door Station



IP Door Station



IP Door Station Board Unit



	N-8640DS	N-8650DS	N-8640SB
Power Source	Power supply device that complies with IEEE802.3af standard or 12V DC (supplied from the AC adapter (option))		
Power Consumption	5 W (max.)		
Speech Method	Hands-free conversation		
Audio Frequency Range	300 Hz – 7 kHz		
Contact Input	1 channel, no-voltage make contact input, open circuit voltage: 5V DC, short circuit current: 10mA or less, unterminated ends		
Contact Output	Open collector output, 4 channels, withstand voltage: 30V DC, control current; Max. 50mA (4 output 1COMMON), unterminated ends Relay contact output, 1 channel, withstand voltage; 30V DC. control current: Max. 500mA, unterminated ends		
External Speaker Terminal	0.5 W, 8 ohms		
Network Section			
Network I/F	10BASE-T/100BASE-TX (Automatic-Negotiation)		
Network Protocol	TCP/IP, UDP, ARP, ICMP, HTTP, RTP, IGMP		
Audio Packet Transmission System	Unicast, Multicast		
Voice Packet Loss Recovery	Silence insertion		
Audio Delay Time	80ms, 320ms (controllable on the software)		
Finish	Panel: Stainless steel, hairline/ Call button: Metal	ABS resin, dark gray	-
Dimensions	115 (W) x 162 (H) x 58.5 (D)mm	117.2 (W) x 162 (H) x 60 (D)mm	79 (W) x 134 (H) x 53 (D)mm
Weight	780 g	400 g	350 g
Options	For flush-mount: 3-gang electrical box or Back Box YC-150, Wall surface-mount: Wall mount Box YS-13A, AC adapter: AD-1210P, AD-1215P		AC adapter: AD-1210P, AD-1215P

0 dB= 1 V

2-Wire Type Station

Multifunctional Master Station



Standard Master Station



Standard Hands-free Master Station



Industrial-use Master Station



Heavy Industrial Station



	N-8000MS	N-8010MS	N-8011MS	N-8020MS	N-8065MS Q-TEE
Power Source	48V DC (supplied from the IP network intercom exchange)				
Power Consumption	2.4 W (max.)				
Wiring Method	1 set of twisted pair cable				
Speech Method	Hands-free or handset conversation		Hands-free conversation	Hands-free or handset conversation	Hands-free conversation
Audio Frequency Range	300 – 7,000Hz				
Transmission Range	Max. 1500 m (ø0.65 mm. Loop resistance 170Ω)				
Dial-in Contact Output	-	-	-	Open collector output (The contacts have polarity,)/ Withstand voltage: Max. 30V DC, Control current: Max. 50mA, screwless connector (2P)	-
External Speaker Terminal	0.6W, 8Ω, screwless connector (2P)	-	-	0.6W, 8Ω, screwless connector (2P)	0.5W, 8Ω, screwless connector
Dust/Water Protection	-	-	-	IP54	IP65
Resistance to Environment	-	-	-	-	Vandal-, fire- and shock-proof
Finish	Body, Handset: ABS resin, gray		Body: ABS resin, gray	Body, Handset: ABS resin, gray	Body: Aluminum, orange
Dimensions	148 (W) x 208 (H) x 70.5 (D)mm(excluding a curl cord section)		2 (W) x 195 (H) x 56.1 (D)mm	170 (W) x 220 (H) x 97.8 (D)mm (excluding a curl cord section)	160 (W) x 360 (H) x 91 (D) mm (without cable glands)
Weight	800 g	700 g	400 g	1 kg	3.75 kg
Options	Wall mounting bracket: YC-280		Wall mounting bracket: YC-290	Wall mounting bracket: YC-280	-

0 dB= 1 V

Flush-Mount Master Station



Flush-Mount Hands-free Master Station



Master Station Board



Door Station



Door Station Board



	N-8033MS	N-8031MS	N-8031SB	N-8050DS	N-8050SB
Power Source	48V DC (supplied from the IP network intercom exchange)				
Power Consumption	2.4 W (max.)				
Wiring Method	1 set of twisted pair cable				
Speech Method	Hands-free or handset conversation				
Audio Frequency Range	300 – 7,000Hz				
Transmission Range	Max. 1500 m (ø0.65 mm. Loop resistance 170 Ω)				
Contact Output	-	-	-	Open collector output, withstand voltage: Max. 30V DC, control current: Max. 50mA, one shot: can be set from 1 to 9 sec, screw terminal (polarized)	
External Dial Input	No-voltage make contact input, open voltage: 5V DC, short-circuit current: 1mA, screwless connector (5 pins)			-	-
Housing Protection	-	-	-	BS EN62262: 2002: IK02 equivalent	-
Dust/Water Protection	IP65 (Note that panel edges must be sealed at installation.)	-	-	IP54 (Note that panel edges must be sealed at installation.)	-
Resistance to Environment	Chemical Resistant	-	-	-	-
Finish	Membrane switch (Front pasting): Polyester film	Panel: Stainless steel (SUS304), hairline	-	Panel: Stainless steel, hairline/ Call button: Metal	-
Dimensions	115 (W) x 254 (H) x 54.6 (D)mm		70 (W) x 185 (H) x 20.6 (D)mm	115 (W) x 162 (H) x 54 (D)mm	67 (W) x 128.3 (H) x 26 (D) mm
Weight	850 g		205 g	680 g	100 g (including accessories)
Options	Back Box YC-841	Flush-mount: Back Box, YC-241 Wall surface-mount: Wall mount Box YC-251 Handset: RS-191	Handset: RS-191	Flush-mount: 3-gang electrical box or Back Box YC-150 Wall surface-mount: Wall mount Box YS-13A	-

0 dB= 1 V

Specifications

IP Network Exchange

IP Network Intercom Exchange



	N-8000EX	N-8010EX
Power Source	CE ver.: 220 - 240 V AC, 50/60 Hz / CU ver.: 120 V AC, 50/60 Hz	
Power Consumption	500 W (at rated), 75 W (max.)	
Interface Section or Station		
Speech Link	Internal: 4/External: 8	Internal: 1/External: 2
Line Capacity	Up to 16 stations	
Wiring Method	1 set of twisted pair cables	
Transmission Range	Max. 1500 m (ø0.65 mm. Loop resistance 170 Ω)	
Paging Output	Audio: 2 channels Max. 0dB*, 600Ω, balanced, detachable terminal block Control: 2 channels, no-voltage make contact output (24V DC/0.5A), removable terminal block	Station paging only
Network Section		
Network I/F	10BASE-T/100BASE-TX (Automatic-Negotiation)	
Network Protocol	TCP/IP, UDP, ARP, ICMP, HTTP, RTP, IGMP	
Audio Packet Transmission System	Unicast, Multicast	
Voice Packet Loss Recovery	Silence insertion	
Audio Delay Time	80ms, 320ms (controllable on the software)	
Finish	Pre-coated steel plate, black, 30% gloss	
Dimensions	420 (W) x 44.3 (H) x 356 (D)mm	
Weight	4.1kg	4.2kg

0 dB= 1 V

Interface Unit

Multi Interface Unit



Direct Select Unit



Audio Interface Unit



	N-8000MI	N-8000DI	N-8000AF
Power Source	CE ver.: 220 - 240 V AC, 50/60 Hz / CU ver.: 120 V AC, 50/60 Hz		
Power Consumption	CE ver.: 24W (230mA) (max.)/CU ver.: 21W (330mA) (max.)	16 W (Max.)	7 W (Max.)
Audio Input	Input: 2 inputs (2P/input), Max. 0dB*, under 600Ω, balanced, with a semi-fixed volume for adjustment (0 to -25dB) Control: 2 inputs (2P/input), no-voltage make contact input, open voltage: 12V DC, short-circuit current: 10mA Removable terminal block (8 pins)	-	1 input (transformer isolated), -58dB* to 0dB*, 2kΩ, balanced (MIC/LINE input, controllable on the software) with input volume control knob, removable terminal block (3 pins)
Audio Output	Output: 2 outputs (2P/output), Max. 0dB*, under 600Ω, balanced Control: 2 outputs (2P/output), relay contact output, contact capacity: 24V DC/0.5A Removable terminal block (8 pins)	-	1 output (transformer isolated), 0dB*, 600Ω, balanced, removable terminal block (3 pins)
Contact Input	16 inputs, no-voltage make contact input, open voltage: 12V DC, short-circuit current: 10mA, removable terminal block (18 pins) (1 common terminal for 4 inputs)	32 inputs, no-voltage make contact input, open voltage: 24V DC, short-circuit current: 5mA or less, removable terminal block (20 pins) (1 common terminal for 4 inputs)	8 inputs, no-voltage make contact input, open voltage: 24V DC, short-circuit current: 5mA or less, removable terminal block (10 pins), (1 common terminal for 4 inputs)
Contact Output	16 outputs, relay contact output, contact capacity: 24V DC/0.5A, removable terminal block (18 pins)	32 outputs, relay contact output, contact capacity: 24V DC/2 - 500mA, removable terminal block (32 pins)	8 outputs, relay contact output, contact capacity: 24V DC/2 - 500mA, removable terminal block (32 pins)
Network Section			
Network I/F	10BASE-T/100BASE-TX (Automatic-Negotiation)		
Network Protocol	TCP/IP, UDP, ARP, ICMP, HTTP, RTP, IGMP		
Audio Packet Transmission System	Unicast, Multicast		
Voice Packet Loss Recovery	Silence insertion	-	Silence Insertion
Audio Delay Time	80ms, 320ms (controllable on the software)		
Finish	Pre-coated steel plate, black, 30% gloss		
Dimensions	420 (W) x 44.3 (H) x 239.5 (D)mm	420 (W) x 44.3 (H) x 267 (D)mm	210 (W) x 44.3 (H) x 267 (D)mm
Weight	2.8 kg	2.8 kg	1.7 kg
Options	-	Wall mounting bracket: YC-850	Rack mounting bracket: MB-15B-BK, MB-15B-J Wall mounting bracket: YC-850

0 dB= 1 V

Interface Unit

Telephone Interface Unit



C/O Interface Unit



	N-8000AL	N-8000CO
Power Source	CE ver.: 220 - 240 V AC, 50/60 Hz / CU ver.: 120 V AC, 50/60 Hz	
Power Consumption	8 W (Max.)	7 W (Max.)
Line: Public Switched telephone networks		
Number of Lines	1 line	
Selective Signal Type	DTMF Signal	
Signal System	-	Compatible with loop start signaling
Monitor Function	Line Loop detection	-
Control Function	Caller ID function	-
Wiring Method	1 pair of twisted pair cables	
Transmission Range	Max. 1500 m (ø0.65 mm. Loop resistance 170 Ω)	
Network Section		
Network I/F	10BASE-T/100BASE-TX (Automatic-Negotiation)	
Network Protocol	TCP/IP, UDP, ARP, ICMP, HTTP, RTP, IGMP	
Audio Packet Transmission System	Unicast, Multicast	
Voice Packet Loss Recovery	Silence insertion	
Finish	Pre-coated steel plate, black, 30% gloss	
Dimensions	210 (W) x 44.3 (H) x 267 (D)mm	
Weight	1.7 kg	
Options	Rack mounting bracket: MB-15B-BK, MB-15B-J, Wall mounting bracket: YC-850	

0 dB= 1 V

IP Interface Module

IP Interface Module



	SX-200IP
Network Section	
Network I/F	10BASE-T/100BASE-TX (Automatic-Negotiation)
Network Protocol	TCP/IP, UDP, ARP, ICMP, HTTP, RTP, IGMP
Connector	RJ45 connector
Voice sampling frequency	16 kHz, 8 kHz (controllable on the software) 48 kHz, sample rate is used for SX-2000 system only
Quantifying bit number	16-bit
Voice encoding method	Sub-band ADPCM, Cryptosystem
Voice Packet Loss Recovery	Silence insertion
Audio Delay Time	80ms, 320ms (controllable on the software)
Indicator	Operation indicator (RUN)
Finish	Panel: Pre-coated steel plate, black, 30% gloss
Dimensions	35(W) x 119.5(H) x 178.4 (D) mm
Weight	150 g

Specifications

**2-Core
Shielded
Cable Type**

Sub-station Interface Unit



	N-8000RS	N-8010RS
Power Source	CE ver.: 220 - 240 V AC, 50/60 Hz / CU ver.: 120 V AC, 50/60 Hz	
Power Consumption	CE ver.: 40W(at rated), 50W(max.) / CU ver.: 35W(at rated), 45W(max.)	CE ver.: 32W (at rated), 38W (max.) / CU ver.: 26W (at rated), 32W (max.)
Interface Section for Sub-station		
Number of links	16 lines	
Number of Speech Links	2 links	1 link
Transmission Range	500m/ø0.5mm, 800m/ø0.65mm, 1300m/ø0.9mm	
Wiring Method	Two-core shielded cable	
Network Section		
Network I/F	10BASE-T/100BASE-TX (Automatic-Negotiation)	
Network Protocol	TCP/IP, UDP, ARP, ICMP, HTTP, RTP, IGMP	
Audio Packet Transmission System	Unicast, Multicast	
Voice Packet Loss Recovery	Silence insertion	
Audio Delay Time	80ms, 320ms (controllable on the software)	
Finish	Pre-coated steel plate, black, 30% gloss	
Dimensions	420 (W) x 44.3 (H) x 325.5 (D)mm	
Weight	3.9 kg	3.8 kg
Options	Wall mounting bracket: YC-850	

Sub-station (Emergency use)



RS-180

Sub-station (Outdoor Vandal-Resistant Type)



RS-170

Sub-station (Indoor Vandal-Resistant Type)



RS-160

Sub-station (Indoor use)



RS-150

	RS-180	RS-170	RS-160	RS-150
Contact Output	Open collector output: 24V DC, 30mA (The open collector output is kept turned on till the conversation is finished after the call button was pressed.)	-		
Finish	Panel: Stainless steel (SUS304), hairline Call Button: Metal, red Printed Circuit Board: Weather-resistant coating	Panel: Stainless steel (SUS304), hairline Call Button: Metal	Panel: Stainless steel (SUS304), hairline Call Button: Resin, black	
Dimensions	120 (W) x 120 (H) x 58.5 (D)mm	120 (W) x 120 (H) x 57.5 (D)mm		120 (W) x 120 (H) x 48.5 (D)mm
Weight	570g	540 g		410 g
Options	2-gang electrical box: YC-302, Indoor wall-mount box: YC-822, Outdoor wall-mount box: YC-823	2-gang electrical box: YC-302, Indoor wall-mount box: YC-822, Outdoor wall-mount box: YC-823	2-gang electrical box: YC-302, Indoor wall-mount box: YC-822	

IP Intercom Switch Panel



RS-144

IP Intercom Switch Panel



RS-143

Switch Panel



RS-140

IP Intercom Switch Board



RS-142

	RS-144	RS-143	RS-140	RS-142
Call-in Switch	Momentary (EMERGENCY, NORMAL)	Momentary		
Privacy Switch	-			Latching
Wiring	Two-core shielded cable			
Finish	Panel: Stainless steel, hairline Call-in Switch: Resin, red Privacy Switch (normal): Resin, white	Panel: Stainless steel, hairline Call-in Switch: Resin, red	Panel: Stainless steel, hairline Call-in Switch: Resin, red Privacy Switch (normal): Resin, white	
Dimensions	70 (W) x 115 (H) x 28.6 (D)mm			
Weight	80 g			
Options	Flush-mount box: YC-801, Wall-mount box: YC-802, Handset: RS-141			
Call Switch Wiring				4 cables (for 2 momentary switches)
Wiring	Two-core shielded cable			
Weight	30 g			

4-Wire Type

Sub-station Interface Unit



Analog Standard Master Station



N-8400RS	
Power Source	CE ver.: 220 - 240 V AC, 50/60 Hz / CU ver.: 120 V AC, 50/60 Hz
Power Consumption	CE ver.: 35 W(at rated), 50 W(max.) / CU ver.: 30 W(at rated), 45W(max.)
Interface Section for Sub-station	
Number of links	16 lines
Number of Speech Links	2 links
Transmission Range	1 km/ø0.5mm, 1.5 km/ø0.65mm, 2 km/ø0.9mm
Wiring Method	2 sets of twisted pair cables
Network Section	
Network I/F	10BASE-T/100BASE-TX (Automatic-Negotiation)
Network Protocol	TCP/IP, UDP, ARP, ICMP, HTTP, RTP, IGMP
Audio Packet Transmission System	Unicast, Multicast
Voice Packet Loss Recovery	Silence insertion
Audio Delay Time	80ms, 320ms (controllable on the software)
Finish	Pre-coated steel plate, black, 30% gloss
Dimensions	420 (W) x 44.3 (H) x 325.5 (D)mm
Weight	4 kg
Options	Wall mounting bracket: YC-850

N-8410MS	
Power Source	24V DC (supplied from the sub station interface unit N-8400RS)
Current Consumption	Max. 30 mA
Wiring Method	2 sets of twisted pair cables
Speech Method	Hands-free or handset conversation
Audio Frequency Range	300 Hz – 7 kHz
Transmission Range	1 km/ø0.5mm(AWG24), 1.5 km/ø0.65mm(AWG22), 2 km/ø0.9mm(AWG19)
Finish	Body, Handset: ABS resin, gray
Dimensions	148 (W) x 208 (H) x 70.5 (D)mm (excluding a curl cord section)
Weight	720 g
Options	Wall mounting bracket: YC-280

0 dB= 1 V

Sub-station (Emergency use)



RS-480



RS-481

Sub-station (Outdoor Vandal-Resistant Type)



RS-470

Sub-station (Indoor Vandal-Resistant Type)



RS-460

Sub-station (Indoor use)



RS-450

RS-480		RS-470		RS-460		RS-450	
Call-in Switch	Momentary (Emergency call: Press twice within 400 ms)						
Contact Output	Open collector output: 30V DC, 30mA		-				
Wiring	Twisted pair cables (2-pair)						
Dust/Water Protection	IP54		-				
Finish	Panel: Stainless steel, hairline Call switch: Metal, red Circuit Board: Weather-resistant coating		Panel: Stainless steel, hairline Call switch: Metal, silver		Panel: Stainless steel, hairline Call Switch: Resin, black		
Dimensions	120 (W) x 120 (H) x 50.5 (D)mm		120 (W) x 120 (H) x 49.5 (D)mm		120 (W) x 120 (H) x 41.5 (D)mm		
Weight	575 g		550 g		540 g		510 g
Options	2-gang electrical box: YC-302, Handset: RS-481 Indoor wall-mount box: YC-822, Outdoor wall-mount box: YC-823		2-gang electrical box: YC-302, Indoor wall-mount box: YC-822, Outdoor wall-mount box: YC-823		2-gang electrical box: YC-302, Indoor wall-mount box: YC-822		

IP Intercom Switch Board



RS-442	
Call Switch Wiring	6 cables (for 3 momentary switches)
Wiring	Twisted pair cable(2-pair)
Weight	140 g



YC-850 Wall-Mount Bracket

Designed to mount N-8000RS, N-8010RS, N-8400RS, N-8000DI, N-8000AF, N-8000AL and N-8000CO on a wall.
Finish: Surface-treated steel plate, black, 30% gloss
Dimensions: 45.1 (W) x 220 (H) x 10 (D)mm



YC-280 Wall-Mount Bracket

Designed to mount N-8000MS, N-8010MS, N-8020MS, N-8410MS, and N-8600MS on a wall.
Finish: Surface-treated steel plate, gray, paint
Dimensions: 100 (W) x 140 (H) x 31.8(D) mm



YC-290 Wall-Mount Bracket

Designed to mount N-8011MS on a wall.
Finish: Surface-treated steel plate, gray, paint
Dimensions: 64 (W) x 131.5 (H) x 31.8 (D) mm



YC-251 Surface-Mount back Box

Designed to mount N-8031MS on a wall.
Finish: Surface-treated steel plate, white
Dimensions: 124 (W) x 258.5(H) x 50.5(D) mm



YC-241 Flush-Mount Back Box

Designed to mount N-8031MS in a wall.
Finish: Colored chrome painting
Dimensions: 276 (W) x 119 (H) x 67 (D) mm



YC-150 Flush-Mount Back Box

Designed to flush-mount N-8050DS and N-8640DS in a wall.
Finish: Zinc-plating
Dimensions: 184 (W) x 119 (H) x 57 (D) mm



YC-801 Flush-Mount Box

Designed to flush-mount RS-140, RS-143 and RS-144 in a wall.
Finish: Colored chrome painting
Dimensions: 72 (W) x 119 (H) x 57 (D) mm



YS-13A Surface-Mount Back Box

Designed to surface-mount N-8050DS and N-8640DS in a wall.
Finish: Zinc-plating
Dimensions: 163.5 (W) x 116.5 (H) x 55 (D) mm



YC-802 Wall-Mount Box

Designed to flush-mount RS-140, RS-143 and RS-144 in a wall.
Finish: Surface-treated steel plate, white
Dimensions: 75 (W) x 124 (H) x 50.5 (D) mm



YC-302 2-Gang Electrical Box

Designed to mount RS-150, RS-160, RS-170, RS-180, RS-450, RS-460, RS-470 and RS-480 in a wall.
Finish: SPHT, MFZn4 (glazed chromate)
Dimensions: Outlet box: 102 (W) x 102 (H) x 44 (D) mm / Cover: 106 (W) x 106 (H) x 13 (D)mm



YC-841 Back Box

Designed to flush-mount N-8033MS on a wall.
Finish: Surface-treated steel plate, white
Dimensions: 119 (W) x 258 (H) x 57 (D) mm



YC-823 Outdoor Wall-Mount Box

Designed to mount RS-170, RS-180, RS-470 and RS-480 on a wall.
Finish: Stainless plate, off-white
Dimensions: 124 (W) x 124 (H) x 62 (D) mm.



AC Adapter

AC adapters to operate the IP Station on AC.
Power Source :
AD-1210P: 230 V AC
AD-1215P: 100 - 240 V AC



YC-822 Indoor Wall-Mount Box

Designed to mount RS-150, RS-160, RS-170, RS-180, RS-450, RS-460, RS-470 and RS-480 on a wall.
Finish: Surface-treated steel plate, white
Dimensions: 124 (W) x 124 (H) x 61 (D) mm



TOA Electronics Pte Ltd
www.toa.com.sg

Specifications are subject to change without notice.
Printed in Singapore (65) 865-0817-03

