

Household Gas Water Heater [For Indoor Use Only]

User instruction manual (with Warranty Card)

Installation guideline

Model No.

GQ-531WMY

Ventilation Warning



Please ensure that this unit is installed at an area with adequate ventilation by means of having ventilation fan, windows, etc. Poor ventilation may result in carbon monoxide poisoning due to incomplete combustion, and subsequently causing fatal accident to the user.

Introduction

How to read instructions _____ 2
 What are available _____ 2
 Safety functions _____ 3
 Necessary instructions to follow
 (Safety warning) _____ 4-7

Before using

Part name & function _____ 8
 How to install batteries _____ 9
 For the first time using _____ 10

How to use

Preparing & Dispensing Hot
 water _____ 11
 Adjusting water temperature _____ 12
 Dispensing hot water _____ 13
 To release/drain away
 remaining hot water _____ 14

Just in case

Daily inspection &
 maintenance _____ 15-16

Troubleshooting

Doubts, defects or
 abnormality _____ 17-18
 Warning notification _____ 19

Reference

After service _____ 20
 Main specifications _____ 21
 Product external dimension _____ 22

Installation guideline

Warranty card



36559800

T才98

Introduction

Thank you very much for supporting  **NORITZ** products. This unit is distributed by Zenne Infinity Sdn. Bhd.

- Please read this instruction manual carefully and use this unit correctly.
- Please confirm the date of purchase, retailer's name and other particulars on the warranty section.
- Please keep this instruction manual for future reference.

Explanation of pictures displayed:

» **Structure** Structure small in size

★ **Hint** Usage tip

⚠ **Caution** Please be careful

▶ **Reference** Please refer to Page...

Please refer to Page No. # as indicated as (Pg.#).

Introduction

Capability of the product:-

- **Wide temperature adjustment control for hot water.**

Wider temperature control of hot water by adjusting the water and gas knobs which are located on the front of the unit.

Built-in Safety devices equipped in this unit includes:

1. Flame Failure Safety Device:-

- When no flame or fire is detected in the unit, gas supply will automatically be cut off.
- When this happens, please wait for 10 minutes for any accumulated unburnt gas to be automatically rid off from this unit.
- Do not attempt to restart the heater within this first 10 minutes period. It will be safer to restart the unit **AFTER** 10 minutes.

2. Incomplete Combustion Safety Device:-

▶ Reference

- When the safety device in this unit detects incomplete combustion due to inadequate ventilation or blockage of the heat exchange unit inside this unit. This will shut down gas supply.
- Take note of the flashing red lamp and warning buzzer when this occurs.

Notice Lamp
& Buzzer
(Pg.19)

3. Preventive Re-ignition Locking Device:-

▶ Reference

- This heater is also installed with an auto-locking mechanism which disables the user from restarting the unit after the first 3 failed consecutive attempts which might have been caused by abnormal combustion.
- The notification lamp (red) that lights and the buzzer sounds.
- Gas supply to this unit will automatically be cut off.
- To troubleshoot the unit if this incident occurs, please bring this unit back to our authorised dealers for reset the unit's system back to its default condition.

Notice Lamp
& Buzzer
(Pg.19)

4. Overheating Prevention Device:-

- This heater is also installed with an overheating prevention device. This device ensures that the flame's temperature does not go beyond the temperature range which has been set for this unit.
- Gas supply to this unit will automatically be cut off if the device senses this to occur.
- The unit may also shutdown if the internal parts inside gets overheated while in use.

5. Overpressure Safety Device:-

- Protects the unit from damages due to abnormally high water pressure.

6. Automatic Fire Extinguishing Device:-

▶ Reference

- Should the user abandon the unit while it is still running in the middle of a shower, this safety device helps to extinguish the fire by cutting off the gas supply to the unit after it has operated for 20 minutes.
- The buzzer in this unit can also be triggered. This indicates that the machine is yet to be switched off.
- Upon restarting the unit, ensure ventilation within room to replace possibly polluted air with fresh air.

Notice Lamp
& Buzzer
(Pg. 19)

*Inspection Notice Function:

▶ Reference

- When the green light flashes to notify that it has been used for the 100,000th time (approx. lifespan of 10 years) this unit is required to be serviced.

Notice Lamp
& Buzzer
(Pg.19)

Notice:-

- Gas supply automatically stops when safety device is activated, however water supply still continues.

Necessary Instructions To Follow (Safety Caution)

Below are classifications and indications for prevention beforehand for user and other people from injury or property damage. These all important related to safety. Please be sure to observe, understand deeply, use correctly.



DANGER

:

This sign is marked on items that is known **VERY LIKELY** and **MAY** cause death or serious injury in the event if it happens.



WARNING

:

Failure to obey this safety warning may **POSSIBLY** result in serious injury to the user or to others. Always follow the safety precautions to reduce the risk of fire, electric shock and personal injury.



CAUTION

:

This mark indicates incident such as slight illness or physical damage that may happen if it is ignored or wrongly used.



REQUEST

:

Request to understand for use safety and comfortable.



DANGER

:

Below are classifications and indications for prevention beforehand for user and other people from injury or property damage. Please be sure to observe, understand deeply, use the unit correctly and safely.

When you detect a gas leak,
1. **Immediately stop** using it.

2. **Close the gas knob**
and main gas plug valve.

3. Inform gas dealer
Or dealers.



When gas leak occurs, ...

• **Do not** ignite fire

• **Do not** attempt to switch on any electrical appliances. It may cause explosion.

• **Do not** plug in-out power cord

• **Do not** use telephone.



The spark may cause fire.

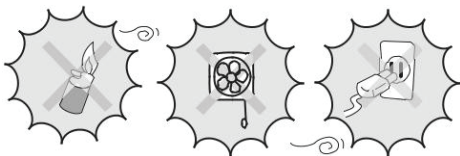

• **Do not** remove, remodel or disassemble the front panel of this unit. Doing so may cause carbon monoxide poisoning which leads to death and fire.

Do not switch on the unit for a long period of time in an enclosed room (especially be careful during cooling/heating). If you do not have enough ventilation, it may lead to fatal accidents. To ventilate the area, open the window or turn on the ventilation fan while in use.

For indoor installation, open the window without turning the ventilation fan (ie. natural ventilation) to ventilate the area. A shortage of oxygen may cause fatal accident such as carbon monoxide poisoning due to incomplete combustion.

※ Even when ventilation has been carried out, abnormal combustion, sound, and odour can still happen during use. If the fire extinguishing device is automatically activated, immediately stop using the unit. Off the main gas valve to stop the gas supply. Contact our dealer to report the incident.



Prohibited!

Do not attempt to reuse the unit.

※ For complete combustion to happen, sufficient ventilation is necessary.

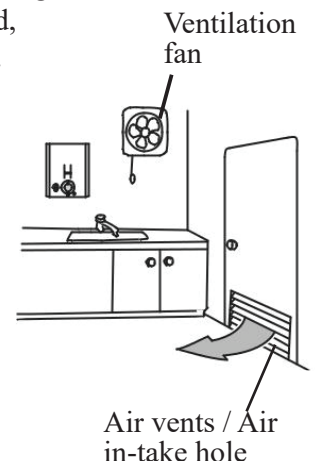

Introduction



WARNING :

If the fire often dies out despite of adequate ventilation, immediately stop using the unit. Off the main gas valve and contact the dealer or the gas supplier.

This concerns with death incidents caused by carbon monoxide poisoning. While using this unit, be aware that the temperature of the hot water may possibly change if there is any sudden change in water pressure.

If there is a need to use this unit for the second time, do check and test the temperature of the water before using. The water output for the second time may either be still hot or even hotter than the previous time used.

Do not touch hot water supply pipe during use or immediately after use due to high temperature. It may burn your skin. Avoid setting water heater at high temperature to avoid burning, especially on children. Gas volume knob should always be set at 'Water' position after each use to ensure safety of next user.

For any tasks regarding installation or re-installation purposes, please request the dealer or a qualified technician to perform the task. This is to ensure that the unit is safely and correctly installed.

For renovation (e.g. attach hanging cabinet) after installed unit, please consult with the dealer.

Possible fire issues vs standard installation

The unit is **indoor use**. **Do not** install outdoor.

Wind, rain causes fire or damages and breakdown to the unit.



Must follow!

The unit and its surroundings must have proper spacing. This is to prevent fire from spreading to its surrounding. (As for maintenance, need distance 60cm to front, 20cm for side.)

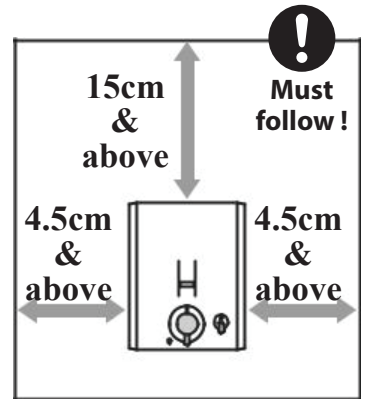

Do not block the exhaust or intake air vent. (E.g. A towel.)

Do not put or install items which catches fire easily near the unit.

This may cause fire, incomplete combustion or may even put out flame and activates the interlock system safety device unnecessarily. Do not install a towel rail on the side of the device because the wind may cause flames to overflow from the air supply and burn flammable combustibles such as towels and clothes near the device. There are also cases where the safety device is activated to extinguish the fire during use.

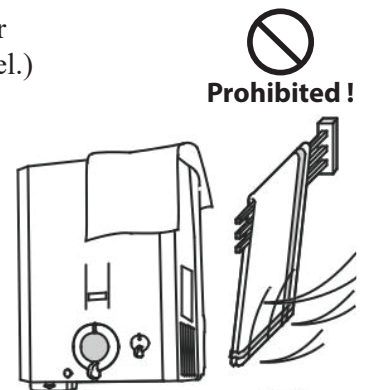

Do not use or place highly flammable items such as benzene, gasoline or aerosol spray cans near the unit.

The heat emitted from the heater may cause the pressure inside the spray can to increase. This may cause the spray can to explode or even cause fire.



Do not sleep or leave the unit while it is still running. This may cause unexpected fire incidents or carbon monoxide poisoning.



Do not place any veneer or plywood on the vents on the exhaust hood. This may cause fire.



Introduction



WARNING :

Must use proper gas as indicated on model plate. If gas is not proper, may cause carbon monoxide poisoning by incomplete combustion, skin burning by abnormal fire or unit breakdown.

In case of shifting to a new environment, please check whether the gas type available in that area suits the unit.

If in doubt, call and clarify with our appointed dealer.

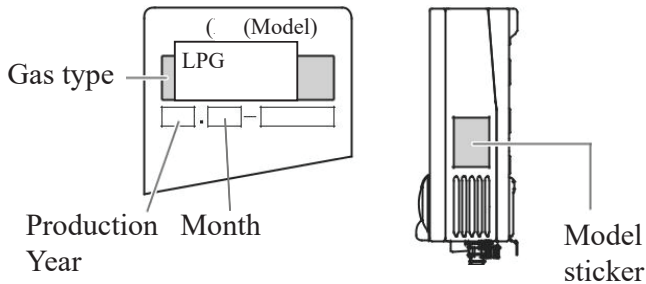

Must follow!

In case the unit shows signs of failure to ignite, yellow flame, abnormal smell, sound, irregular temperature, or repetitive dying flame in the middle of usage, **immediately stop using the unit and close the main gas plug valve.**



Must follow!

Check and treat by 「Failure/abnormal」 (Pg.17). If cannot fix, stop using the unit and call our appointed dealers for repair.

If an earthquake or fire occurs while the unit is in use, immediately close the hot water stopper and extinguish the fire by closing the main gas plug valve.



Must follow!

This is to avoid fire or other unexpected accidents from happening. Since the ventilation fan does not work during power failure/blackout, please pay attention to the air ventilation.



CAUTION :

While using this unit, be aware of the hot water temperature. It may possibly have changed due to sudden change in water pressure.

Before using this unit for the second time, **check and test** the temperature of the hot water output. Its temperature may turn out either hotter than the previous time used.



Must follow!

Do not install the unit near or directly above the gas cooker or gas hob. The heat, oil vapour, and other combustion waste may float adrift into the unit. This may cause internal damage to the unit and shorten the product's lifespan.



Must follow!



While operating or directly after switching off the unit, **avoid** touching the vents of the exhaust hood (Pg.8) or high temperature area around it. **Failure to do so may cause burnt or scalding.**

Do not insert sticks or touch the vents on the exhaust hood. This may not just cause burn to the user but also damage the unit.



Do not touch!



Prohibited!

Do not allow children to operate the unit by themselves. Prohibit children from playing around or under the unit. This is to prevent them from getting burnt or other unexpected incidents.



Prohibited!

When replacing the old gas water heater, please return it back to our appointed dealer for proper disposal. Ensure that the batteries are removed from the unit.



Must follow!

USAGE:

This unit should **ONLY** be used for cleaning and taking baths or showers. Continuous supply of hot water for long period of time (20 minutes and above) may trigger the automatic fire extinguishing safety device.

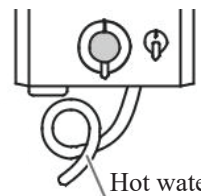

Hot water supply hose

Do not create multiple connections to the hot water outlet as this may cause equipment damage and unexpected accidents.

Be Sure To Observe Safety Cautions



REQUEST :

Check for the fire's condition during ignition stage, while in operation and after use by looking through the small window provided on the front cover.

Ensure that the fire is extinguished before sleeping or leaving the unit and the main gas plug valve is closed.

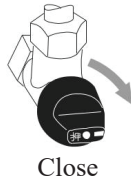

Avoid installing this unit near any doors or windows which has plastic screen mesh attached. The heat of the exhaust emitted by this unit may not only burn but also discolour the plastic screen mesh on the door.

Do not install the unit near plastic or lighting appliances. The heat released by this gas water heater may deform these items and discolour these items.

Reinforced gas hose should not be folded, passed under the unit or touches any parts of the unit's body especially the exhaust hood. This may cause gas leak or even fire.

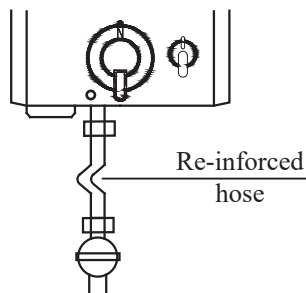

Do not use spa water, well water, underground water or other untreated water. These kind of water may cause damage to the internal piping of the unit. Such defect is **NOT** covered by our warranty.

Do not consume the remaining heated water which has been left in the heater for quite a period of time. Also, do not consume water which is heated in the first round for cooking and drinking. Use it for other purposes instead.

Do not use this unit for commercial purpose. If it is used for commercial purpose, the unit will be overworked. Not only will this shorten the product's lifespan but also void its warranty. This unit caters for domestic use only.

Do not assemble or add on any other accessories to this model unless specified in this manual. It may cause unexpected defects.

Do not operate this unit without batteries.

The unit cannot function when water or gas supply stops. When this happens, do not use the water tap. When the water tap is not turned on and therefore, no combustion happens. At this point, the Gas knob indicator points at minimum, indicated by **(Water)** while the Water knob indicator can be pointing at either position of minimum **(Lo)** or maximum **(Hi)**.

If the knobs are not positioned as such, then fire will ignite automatically when water supply and gas supply recovers.

Please do not run the unit without water.

When using this unit in a well-ventilated area, ensure that the wind does not blow at it directly at this unit. This is to ensure and prevent strong wind from blowing out the flame within the unit. If this happens, it can cause incomplete combustions and triggers the safety device.

Do not install the unit near the gas cooker or hob area. The oil vapour that is produced during cooking may stick onto the unit. This can cause damage to the gas water heater and also fire.

Regular maintenance is required for this heater.

Air on the mountain gets lesser and lesser as its altitude increases. If this unit is installed on high altitude area, it may trigger the safety device to operate due to incomplete combustions.

Part Name and Function

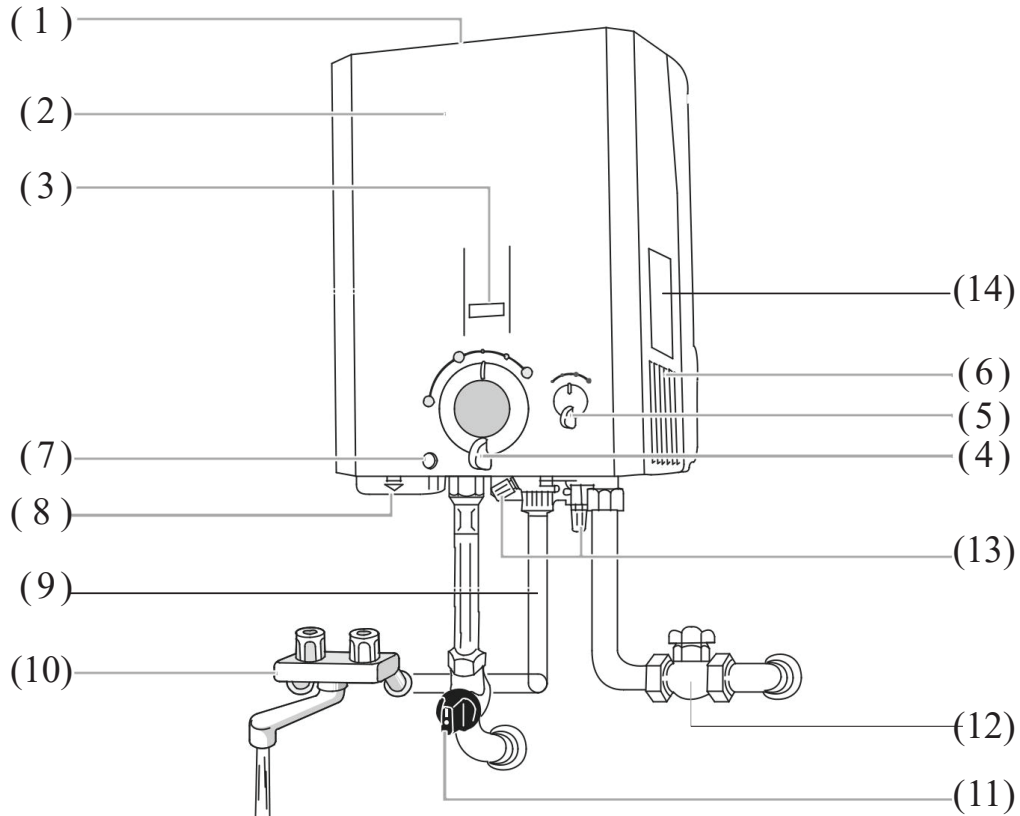

(1) Exhaust hood

- Outlet for exhaust gas (on top surface)

(2) Front panel

- Covers and protects the internal working mechanisms of the unit.

(3) Ignition confirmation window

- Window to enable user to confirm ignition and extinguishment of fire.

(4) Gas knob (Pg.12)

- For gas volume adjustment.

(5) Water knob (Pg.12)

- For water volume adjustment.

(6) Air intake Vents

- Air slots on both left and right sides of the front cover which allows air to flow into the unit for combustion.

(7) Notification lamp (Pg.19)

- Notifies the user when safety device is triggered or when the batteries need to be replaced.

(8) Battery case (Pg.9)

- Houses the 2 D-size batteries.

(9) Hot water output pipe

- Dispenses hot water from the unit to the faucet

(10) Faucet

- When the hot water knob of the faucet is turned on, the flame in the unit is automatically ignited. This starts combustion.
- When this knob is turned off, the flame in the unit is automatically put out. This stops combustion in the unit.

(11) Main gas plug valve (Pg.10)

- Controls gas supply to the unit.

(12) Main water plug valve (Pg.10)

- Controls water supply to the unit.

(13) Water pull-out tap

- Outlet for draining away the remaining water when there is any desire to empty the unit.

(14) Model sticker (Pg.20)

- Indicates gas type, product name, date of manufacture etc.

How To Install Batteries

Preparation

- Close water supply tap
- Close gas supply valve

Process

1 Open the battery case cover

- To open the battery compartment cover, give it a slight push forward at the center of the cover where the “Down” arrow indication is located and allow it to freely swing downwards.
- ※ There is a pick on the upper side.

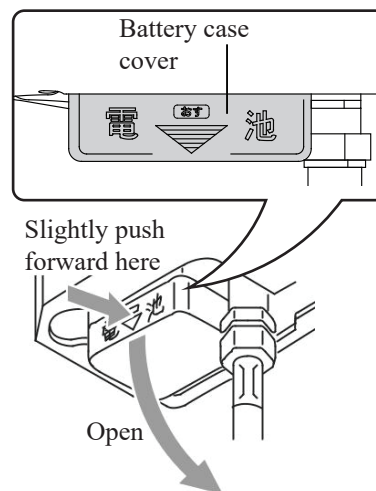

» Structure

- Unit will not work if direction of batteries are wrongly positioned.

! Caution

- **Check the contact point** of the battery case. Please ask for repair if the contact portion is rusty. **Do not** use it.
- Using old with new batteries may cause them to rupture or leak. Likewise, if different brands of batteries are used.

2 Set battery (D-Type x 2 pieces required)

- Terminal indication of battery placement can be seen inside the battery cover.
- These two batteries must be new and the same type. It is recommended to use long life alkaline battery.

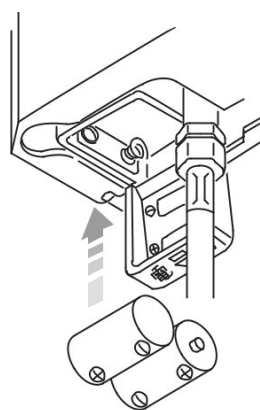

3 Close the cover of the battery compartment

Notice:-

- Batteries are consumables. If the notifying lamp lights up in orange colour when the hot water stopper is turned on. There is either no spark or the interval between sparks are getting longer and longer. It is difficult to ignite. It signifies that the batteries are exhausted and need to be replaced.
- Do not use batteries which are new but expired. Do not mix old batteries with new batteries.
- The orange light may light up in a short time due to natural discharge. The free trial batteries that comes with the unit may have a shorter life due to factory shipment time.
- The batteries' life also vary depending on how frequent the unit is being utilised and also the period or how long it is running each time it is being used.

When Operating For The First Time

- When using this unit for the first time, the following preparations and confirmations are necessary.

Preparation

- Installing the batteries.

Process

Reference

- How to install batteries (Pg.9)

- 1** Turn the water supply tap to maximum.

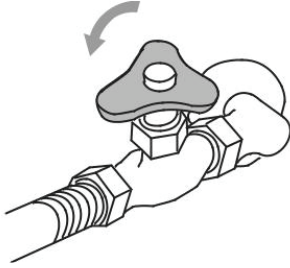

- 2** i.) Set Gas knob to Water position

- ii.) Turn on the hot water knob of the household tap

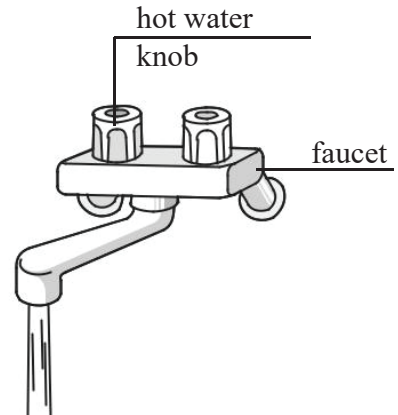
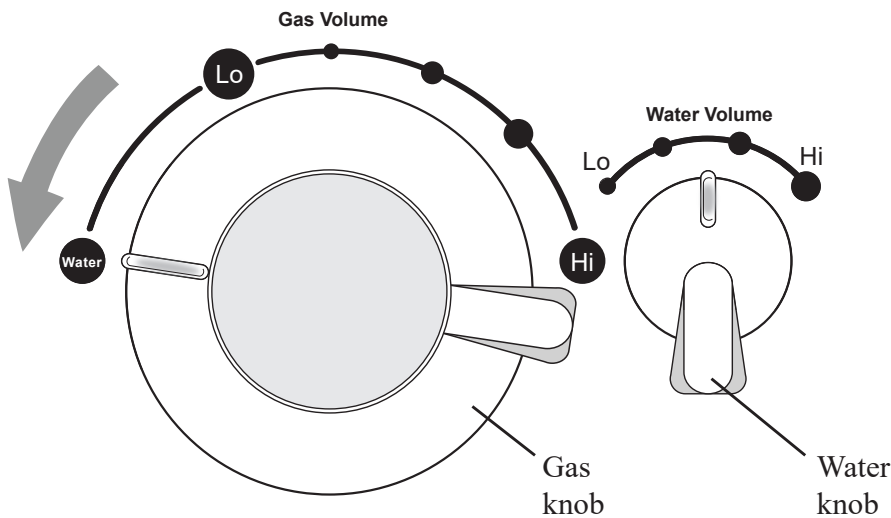

- 3** Check if there is water coming out from the unit, then turn off the hot water knob of the household tap.

Caution

- Do not turn the wrong knob.
- Check before you turn them.

- 4** Turn the main gas valve to maximum.

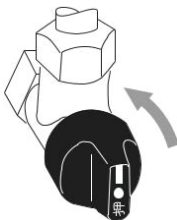

Preparing & Dispensing Hot Water

Preparation

- Check and ensure that the main gas valve is turned to maximum.

Process

1 i.) Set Gas knob at [Lo].

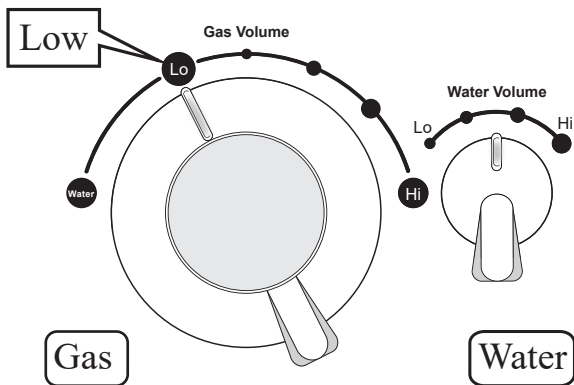

ii.) Set Water knob at [Hi].

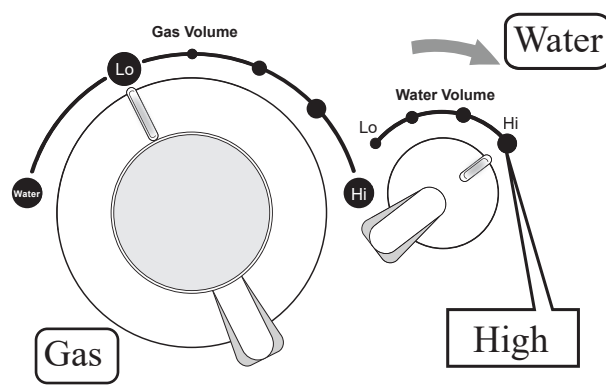

Reference

- Turn the main Gas Valve to open at maximum (Pg.10)

Caution

- Do not control the hot water supply using the main water plug valve. Use the hot water knob on the faucet instead.
- Do not use the gas amount change handle with [Hi]+ Water volume adjustment handle in [Lo] state. Hot water may get out and you may get burnt.

2 Turn on the hot water knob of the faucet, the gas water heater will ignite. Hot water will come out. Look at the window to check if it is ignited.

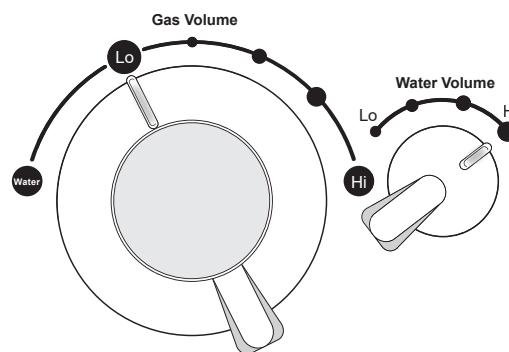
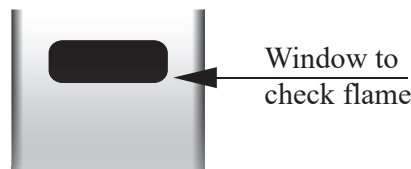
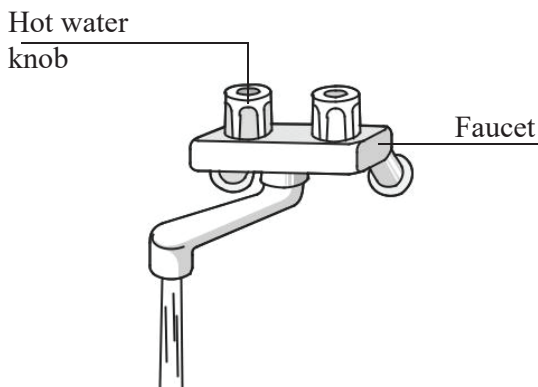

3 Stop hot water, close hot water knob.





- Fire put off, stop hot water.
- Look into the window to check if the fire had stopped.

4 Turn off the main gas valve.

Notice:-

- If the fire does not ignite even though the hot water knob of the household tap is turned to maximum, close it and wait for about 10 seconds. Then, repeat the ignition process.
- Any **immediate attempt of restarting** the heater may delay the ignition process as for the case did not ignite normally.

Adjusting Hot Water Temperature

 <p>WARNING</p>  <p>Must follow!</p>	<p>Take caution as the following instructions can cause scalding.</p> <ul style="list-style-type: none"> • Before making any new changes, carefully test the temperature of the dispensed hot water from the unit by hand and close it • Then, turn the unit on again for the second time to allow the hot water to run. Take extra caution as the water discharged at the beginning of the 2nd flow may be very hot. To ensure that the unit is truly dispensing allow the unit to continue dispensing hot water for approximately 30 seconds. • Please do not use the unit if steam erupts violently from the unit. To overcome this problem, try adjusting the gas and water volume. • After use, please turn the Gas knob to [Water] position for the safety reason. • Temperature adjustment is not controlled by the hot water tap. It is actually controlled by adjusting the Gas knob or Water knob on the unit.
 <p>CAUTION</p>  <p>Prohibited!</p>	<p>While the heater is in use, other person should not adjust the gas or water knob. This may cause burns or unexpected accidents to the user at the very moment.</p>

Using the Water knob:

- Controls the water volume supplied to the unit.
- To **increase the temperature** of the hot water, turn the Water knob to [Lo]. This allows less water to flow through the heater. **(Lower water volume = Hot water)**
The lesser the water volume, the hotter the water will be.
- To **decrease the temperature** of the hot water, turn the Water knob to [Hi]. This allows more water to flow through the heater. **(Higher water volume = Luke warm water)**

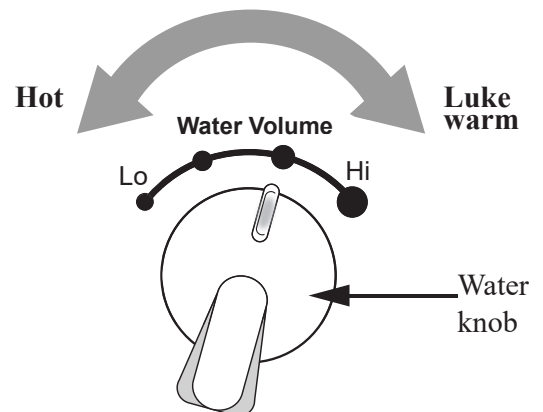

Further tuning the hot water temperature

Using the Gas knob:

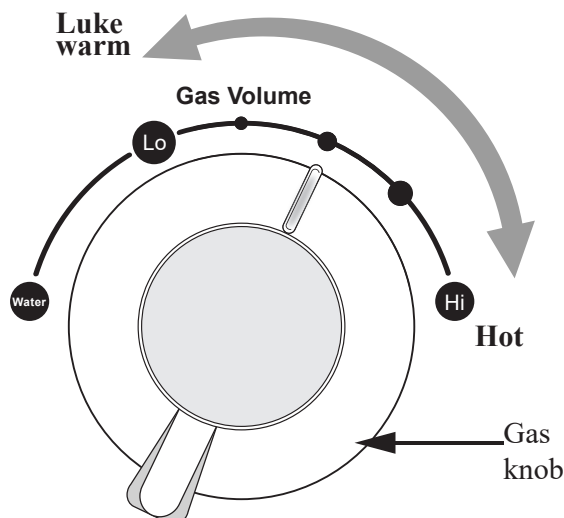

- Controls the gas volume supplied to the unit.
- To **increase the temperature** of the hot water, turn the Gas knob to [Hi]. This increases the gas combustion and releases more heat. **(More gas = Hot water)**
- To **decrease the temperature** of the hot water, turn the Gas knob to [Lo]. This decreases the gas combustion and releases less heat. **(Less gas = Luke warm water)**



» Structure

- When Gas knob indicator is turned from [Lo] to [Water] position, fire is extinguished automatically.

Dispensing Hot Water

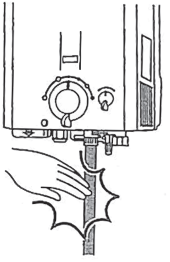
 <p>WARNING</p>  <p>Do not touch!</p>	<p>Caution. Scalding may happen. Do not check hot water temperature by hand. It may be extremely hot. Do not touch hot water pipe during use or immediately after use as it still contains hot water in it. In order to prevent burns at the next use, adjust Water knob to point at [Hi] to stop water.</p>	
---	--	---

Process

1 Follow process Acquiring Hot Water (Pg.11). **1 & 2**

Make sure that the Water knob is in a position other than **[Lo]** and then dispense the hot water.

2 i.) Turn the Gas knob to point at **[Hi]**.

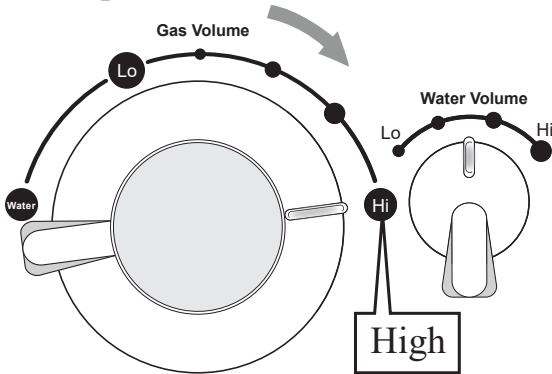

ii.) Turn the Water knob to point at **[Lo]**.

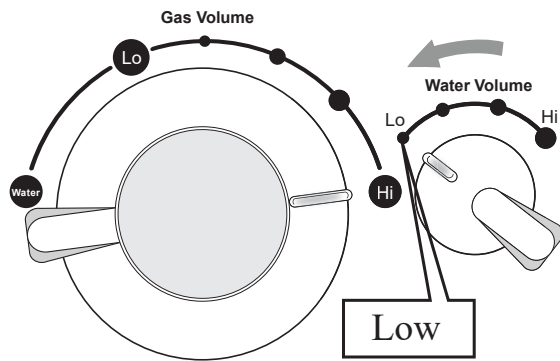

3 When stopping hot water, be sure to follow the procedure below:

i.) Turn the Gas knob to point at **[Lo]**.

ii.) Turn the Water knob to point at **[Hi]**.

iii.) Stop hot water tap

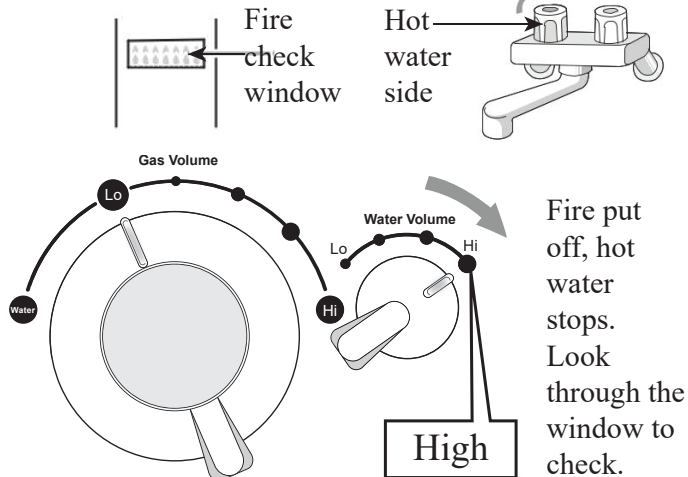
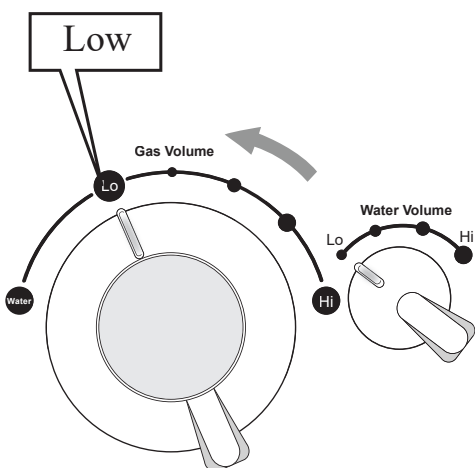

Caution

- If the Water knob is left pointing at **[Lo]** position, hot water may come out and the user may get burnt when using it again.

4 Turn off the main gas plug valve.

To Release / Drain Away Remaining Hot Water

Process

1 Turn the Gas knob indicator to point at [Water].

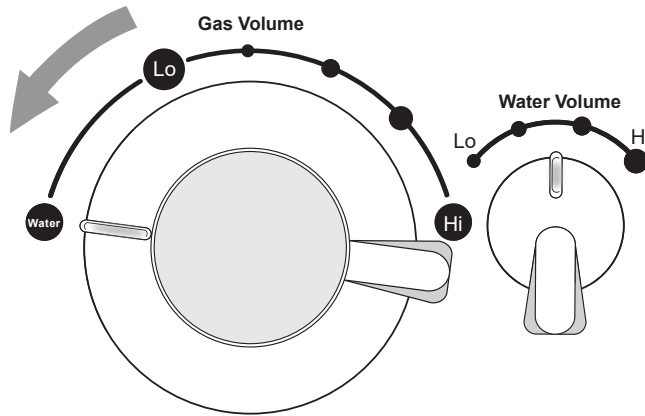

2 Switch on the hot water tap.
Water flows out but there is no ignition.

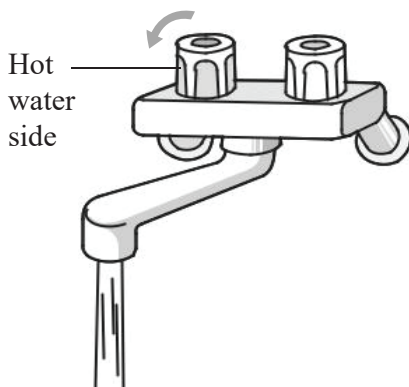

» Structure

- If the Gas knob indicator is turned from [Lo] to [Hi], fire ignites automatically and switches to hot water.

3 Close the hot water tap when hot water stops flowing.

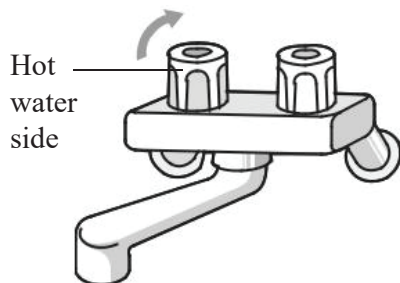

Daily Inspection and Maintenance

- Required periodical inspection and maintenance.

Preparation

- Carry out the inspections and maintenance ONLY after the unit has completely cooled down. The internal parts of the unit may still be hot.
- Protect finger tips from being burnt using rubber gloves.



CAUTION



Prohibited!

Please use mild and gentle dishwashing detergent for cleaning the surfaces of the unit instead of harsh chemicals or corrosive solvents which may remove or wash away warnings, cautions and information from the prints pasted on the unit. **Do not** scrub the surfaces of the unit with rough scrubber or metal scours. They may damage the surface of the unit and spoil the prints on the unit. Harsh chemicals or corrosive solvents such as benzene and ethanol can cause combustion problem. **Do not** touch the exhaust hood on the top of the equipment. If the vent of the exhaust hood deforms, incomplete combustion may occur.

Inspection

Are the air inlets blocked by dust or small particles?

→ (A) If they are, clean them.

Inspection

Is there any abnormal colour change on the front panel?

→ (B) In case there is such phenomenon, contact our appointed dealer or call in to our company.

Inspection

Do you hear any abnormal sound from the equipment?

→ (B)

Is there any gas leakage or water leakage from the equipment or piping? → (C)

please check "if you think there is a failure / anomaly?" (Pg.17).

Inspection

Are there anything which is easy to burn such as laundry, newspaper, wood, kerosene, spray can, etc. around the equipment and exhaust hood (exhaust port)?

Do not place these items around them.

Inspection

Are the batteries exhausted?

→ (D)

When opening the hot water stopper, if the notification lamp (orange) lights up, spark does not occur, interval between sparks becomes long, and it becomes difficult to ignite instantly as the dry cells are exhausted, then replace the batteries. (Pg.9)

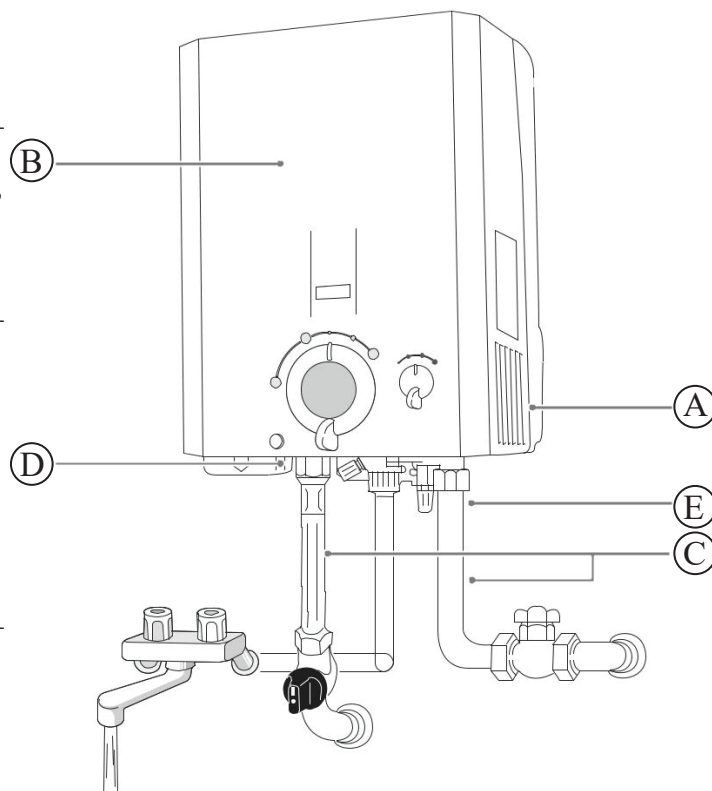

Maintenance

Front Panel → (B)

Please wipe the front panel with a piece of soft and dry cloth. In case there is heavy dirt, wipe with kitchen detergent.

※ **Do not** remove the front panel.

Cleaning

Water filter → (E)

- Clean the water filter if it is clogged up with dirt or dust particles etc. If the unit is not dispensing hot water, please clean it in the following way.

1. Close the main water supply valve.
2. Remove the water supply pipe, pull out the water filter and clean it with a toothbrush.
3. Insert the water filter back into the pipe and install the water supply pipe back onto the unit.
4. Open the main water supply valve.

※ Please check that there is no water leakage.

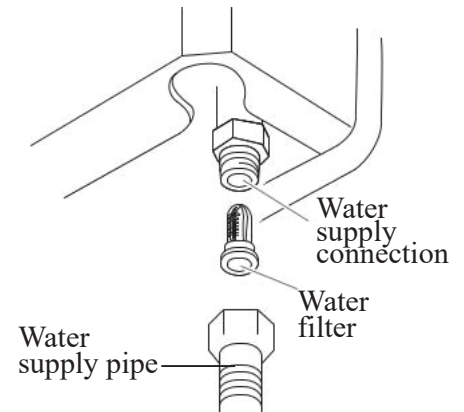

When unit has not being used for a long time

- **When the unit has not being used for a long time, please drain the water to protect the equipment.**

1. Close the main gas plug valve and main water plug valve.
2. Remove the dirt from each part of the unit.
3. Remove the dry batteries from the battery case. Leakage of the dry batteries may cause damage to the unit.

Recommended periodic inspection (Charge base)

Although the unit is still functioning properly, it is recommended that a periodic inspection is to be carried out to prevent unexpected accidents and to enable it to be used for longer time with confidence.

When a problem arised, is it a fault or an abnormality?

- Before requesting for repair, please confirm the following:-
- Is it faulty or anomaly ?
- As soon as you stop using it, please check the following first. Do not hesitate to contact our appointed dealers or call in to Zenne Customer Careline (03-8908 9088) promptly.

Cause & treatment method of failure/abnormality?

Phenomenon		Conceivable	Countermeasures	Page
No ignition	Water supply is OK	Main gas plug valve and main water plug valve are not fully turned on.	Turn the main gas plug valve and main water plug valve to full.	10
		Batteries are flat.	Replace the old batteries with new ones.	9
		Re-ignition prevention (Interlock) is activated.	Follow notice function.	19
		Gas knob at [Water] position.	Turn the Gas knob to [Lo] or [Hi] position.	12
		The re-inforced gas hose breaks.	Replace it with a new re-inforced gas hose.	-
		Not enough gas pressure.	Cylinder gas may be empty. Replace it.	-
		Water pressure is low.	Install a pump to increase water pressure.	-
		Dust blockage at water filter.	Clean the water filter.	16
		Possible malfunction.	Contact our appointed dealer or contact Zenne's customer careline (03-89489088)	-
		No Water supply	The main water valve is not fully opened.	Open the main water valve to full.
Suspension of water supply.	Immediately stop using the unit, and close the main valve.		-	
Fire stops while the unit is in use	Water is running	Main gas and water main valve is not fully opened.	Open the main gas and water valves to full.	10
		Incomplete combustion prevention device is activated.	Follow notice function.	19
		Automatic Fire Extinguishing Device will be activated after 20 mins of continuous use.	Follow notice function.	19
		Shortage of gas supply.	Cylinder gas may be empty. Replace it.	-
		Water supply pressure is low.	Install an external pump to increase water pressure.	-
	Dust blockage in water filter.	Clean the water filter.	16	
	No Water supply	Suspension of water supply.	Stop using the unit and close the main water supply valve.	-





Phenomenon	Conceivable	Countermeasures	Refer Page
High temperature hot water is not available	Main gas valve is not fully turned on.	Turn on the main gas valve to full.	10
	Gas knob & Water knob are not correctly positioned.	Follow [Adjust hot water temperature]	12
Low temperature hot water is not available	The main water valve or the Water knob is not fully open.	Open the main water valve or the Water knob to maximum.	10
	Gas knob is not properly adjusted.	Follow [Adjust hot water temperature]	12
	Water pressure is low.	Install a pump to increase water pressure.	-
	Dust blockage in water filter.	Clean the water filter.	16
Ignition occurs at high temperature but not at low temperature	The main water supply valve is not fully opened.	Open the main water supply valve fully.	10
	Water supply pressure is insufficient.	Install a pump to increase water pressure.	-
	Dust blockage in water filter.	Clean the water filter.	16
Gas or bad smell detected.	Leakage at the gas connection area or there may be flammable items which easily catches fire like plastics placed near the unit.	Discontinue using the unit and remove any surrounding items. If in doubt, contact our appointed dealers or call in to Zenne customer careline service (03-8948 9088) for advice.	5
Yellow flame occurrence.	The ventilation of the room is insufficient.	Open the window or turn on the ventilation fan. Resume using after air ventilation adequately.	4

The following cases are normal phenomenon (Not water heater malfunction).

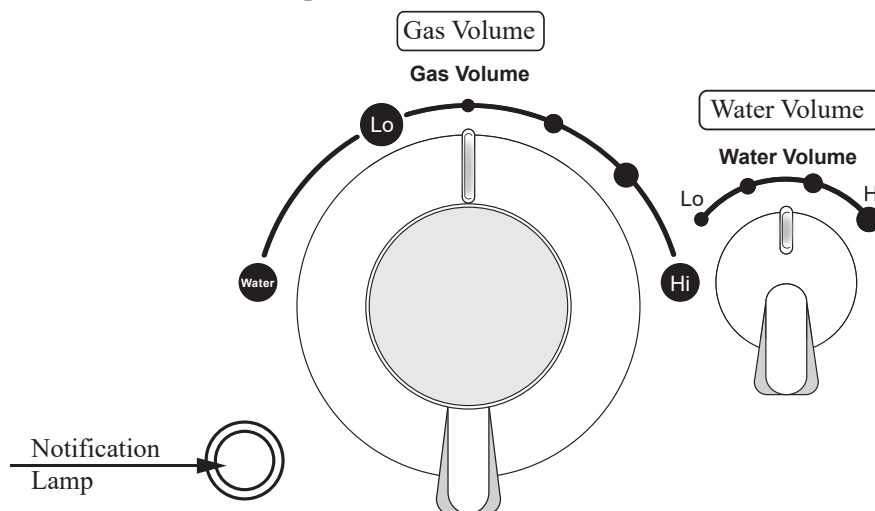
Phenomenon	Reason
The hot water looks white and cloudy.	The cloudiness is usually caused by air bubbles coming out from the solution due to change in temperature. Because cold water holds more air than hot water, small bubbles will appear in the water. This is harmless.
Spark sound can be heard after ignition.	Extra spark sound can be heard after ignition. This is normal condition in order to confirm ignition.
When it is set to high temperature, it will sound 'Shar'.	This is the sound of boiling water.
After stopping the hot water, a sizzling-like sound can be heard. Chiri..Chiri...Chiri...	This is the sound of thermal expansion and contraction.
A small 'pop' sound can be heard when fire is ignited.	This is the sound of ignition.
Flame with a little yellowish tip.	If the position of the Gas knob is at [Lo], the tip of the flame may be a little yellow.
Notification lamp blinks in green colour.	Notification lamp operates after the unit has been used for a long time. Please send the unit back to our appointed dealer or to Zenne customer careline for service (03-8948 9088).

Warning Notification



Indication of Notice Lamp	Buzzer Sound	Cause	Treatment
<p>Red colour lamp blinking</p> 	Pi, Pi, Pi. (10 seconds)	Operating Incomplete Combustion Prevention Device	<ul style="list-style-type: none"> i. Stop using the unit ii. Open the window and switch on the ventilation fan to ensure enough ventilation in the room. The unit is not able to use while red lamp is blinking. iii. This device will be triggered again if there is still insufficient ventilation. When the incomplete combustion prevention device operates three consecutive times, the Re-ignition prevention device operates (Interlock) ※To release Re-ignition prevention device (Interlock) is charged even during warranty period.
<p>Red colour lamp shining</p> 	Piiii..... (10 seconds)	Operating Re-Ignition Prevention Device (Interlock)	<ul style="list-style-type: none"> i. Stop using the unit ii. Close gas valve contact dealer or our company. iii. Red lamp continue lighting until release Re-ignition Prevention device (Interlock). ※ To release Re-ignition prevention device (Interlock) is charged even during warranty period.
<p>Orange colour lamp shining</p> 	-	Time to change batteries.	<p>Replace new battery (Pg.9) ※Recommend long life alkaline battery.</p>
<p>Green colour lamp blinking</p> 	-	Notice inspection time.	Call the dealer to request for an inspection.
<p>Red & Green colour lamp blinking alternately</p> 	-	Possible unit breakdown.	Please inform our appointed dealer or call in to Zenne customer careline (03-8948 9088)
-	Pi, Pi....Pi, Pi (10s interval)	Ignition failure.	<ul style="list-style-type: none"> i. Close hot water valve. ii. Stop hot water (water), iii. Wait for a while for re-ignition (Pg.11)
-	Pi, Pi....Pi, Pi (10s interval)	Operating Prevention Forgetting to Turn OFF the Fire Device	<ul style="list-style-type: none"> i. Stop using hot water, use again by re-starting ii. Every 20 minutes use iii. Automatically stop

★ When closing hot water valve to stop hot water supply, buzzer sound will disappear.

After Sales Service

When requesting for service

- Please check. If you feel that there are other faults or anomalies (Pg.17), please do not hesitate to contact our appointed dealers or call in to our office.

< Necessary Info when you need to contact us >

- Product name or model Number
Indicated on the name plate on the right hand side of the body.

- Product Name

GAS WATER HEATER

- Model Number

GQ-531WMY (5L)

Product : GAS WATER HEATER Model No : GQ-531WMY(5L) Operation of Ignition : DRY BATTERY D-Type Gas Type : LPG Gas Pressure (Pa) : 2.800Pa Distributed By: Zenne Infinity Sdn. Bhd. (HQ) Lot 1863, Jalan Kolej, 43300 Seri Kembangan, Selangor Darul Ehsan, Malaysia/ Tel : +603-89489088 Fax : +603-89489033 http://www.zenne.com.my
Made in Japan
0 0 . 0 0 - 0 0 0 0 0 0 H N Noritz corporation
 RS05 TZZZZ

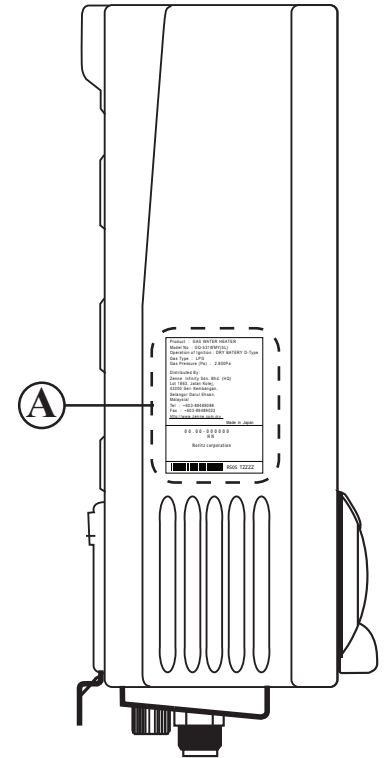

Detail A
(Name Plate)

Warranty card

The warranty card is printed on the last page of this instruction manual. Make sure that the dealer's name, purchase date, etc. are filled in. Please keep this document carefully after reading its contents. For troubleshooting after the free repair period has elapsed, we will repair it for a fee.

Retention period for repair of performance parts

Replacement functional parts will be **available** six years starting from the day this product is terminated. After that period, there may not be any available replacement parts for that model.

When moving or relocating the equipment

When relocating or moving the unit to a new environment, please confirm that the gas type on the model sticker matches the gas type available there. If in doubt, please consult your gas company dealer or contact our company. When moving to areas with different types of gas, remodelling and adjustments of the unit is necessary. The cost accompanying these tasks is to be paid even within the warranty period.

Main Specifications

Specification Table

Category		Small Size Gas Water Heater
Product Name		Gas Water Heater
Model Name		GQ-531WMY
Type	Hot Water Outlet	Front stopping: Temperature of hot water dispensed to the faucet is controlled by the Gas and Water knob located on the front of the unit.
	Air Supply & Exhaust	Open type: Cool air flows into the unit from the opening under the unit and also through the side vents of the front case.
Ignition		Continue sparking
Lowest Water Pressure	< kPa >	35
Water Pressure	< MPa >	0.05 ~ 0.7 (Recommend water pressure 0.1 ~ 0.5)
External Dimension	< mm >	358 (Height) X 288 (Width) X 135 (Depth)
Weight	kg	5.7
Connect	Water Supply	G½ (15A)
	Hot Water Supply	G½ (15A)
	Gas	R½
Safety Device		Flame out failure device, Prevent Incomplete Combustion Device, Prevent Re-Ignite Device (Interlock), Prevent Overheat Device, Prevent Over Pressure Safety Device, & Prevent Forgot Put Out Fire Device.
Accessories		Overpressure Prevention Safety Device draining tube (1 piece), Hose clip (1piece), Dry battery (single - 1.5V) (2 pieces), Metal washer (1 piece), Wood screw (for upper hanger)(1 piece), Wood screw (for upper and lower hanger)(2 pieces) Instruction manual (c/w warranty card & construction manual)(1 piece)

Performance Table

Gas Type and Group	Gas Consumption <kW> Per Hour Maximum	Hot Water Output Capability (Gas Consumption Maximum) <L/Minute>	
		Increase 25°C	Increase 45°C
LPG	10.1	4.8	3.0

- Hot Water Output Capability when water supply is at 0.1MPa.
- Gas has a standard pressure of 2880Pa.

Product External Dimension

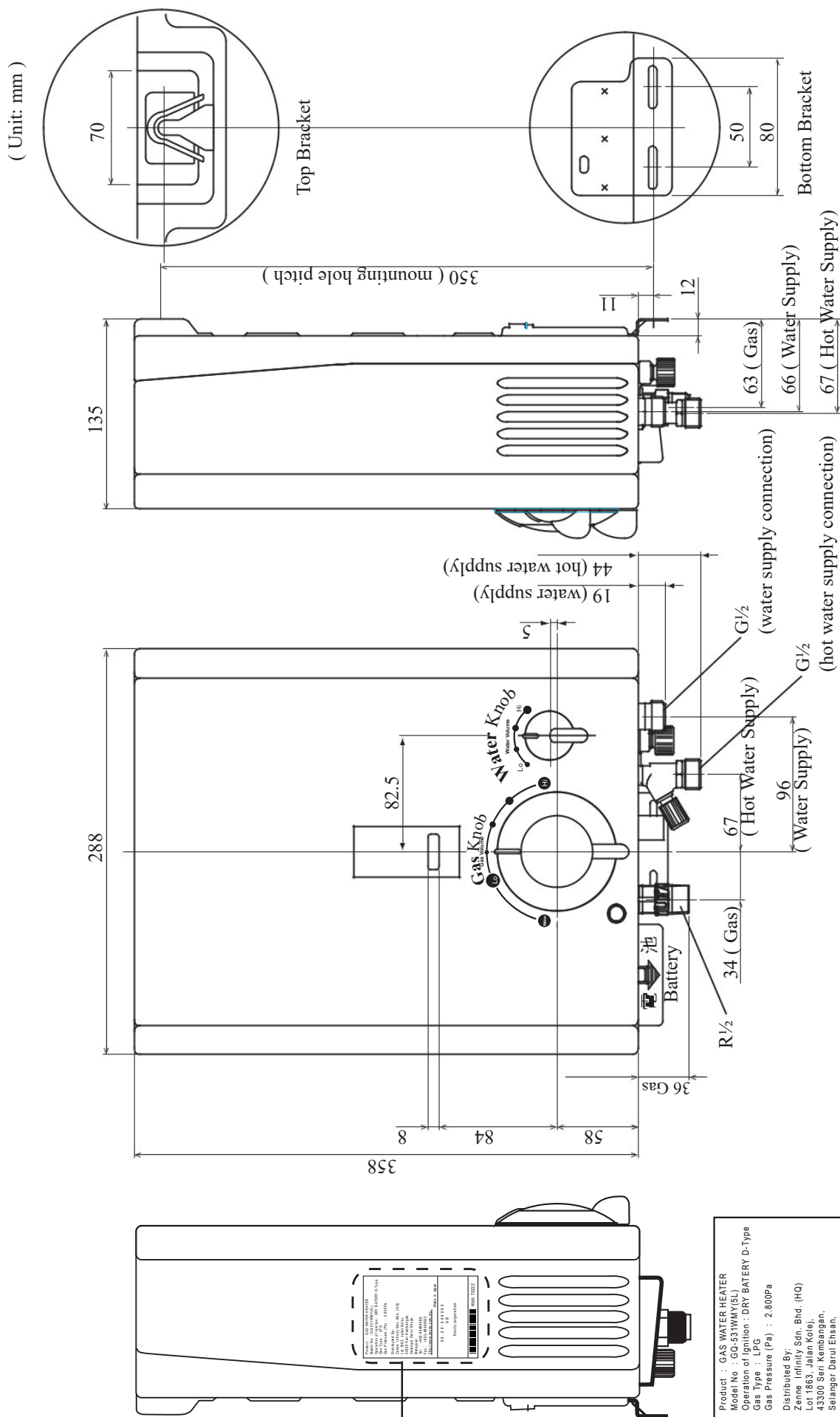

Product : GAS WATER HEATER Model No. : GO-531M(WYSL) Operation of ignition : DRY BATTERY D-Type Gas Type : LPG Gas Pressure (Pa) : 2,800Pa Distributed By: Zenme Infinity Sdn. Bhd. (HO) Lot 1863, Jalan Kolej, 43300 Seri Kembangan, Selangor Darul Ehsan, Malaysia/ Tel. : +603-89489088 Fax : +603-89489033 http://www.zenme.com.my/	Made in Japan 00 0 0 0 0 0 0 0 0 HN Noritz corporation	RS05 TZZZZ
--	---	----------------



Detail A
(Name Plate)

Installation Guideline

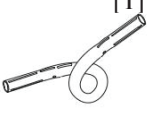

1. Confirmation of accessory parts

- ※ Confirm the accessories before installing.
- ※ Quantity of items are indicated in brackets [].

● To install on unit.

Overpressure Prevention safety device draining tube	Hose clip	Dry battery (single 1.5V)
[1]	[1]	[2]
		

● To mount unit onto the wall.

Metal washer	Wood screw for upper hanger (5X20mm)	Wood screw for lower hanger (4.5X20mm)
[1]	[1]	[2]
		

● Manuals for references.

Instruction Manual (c/w Warranty & Construction Manual)
[1]

2. Safety Precautions



DANGER

- Installation place has enough margin for ventilating air intake and exhaust with the opening or ventilation fan.
- ※ If it is installed in a place with insufficient ventilation, there is a risk of fatal accidents due to carbon monoxide poisoning by incomplete combustion.
- **Do not** install in small, enclosed and unventilated room, e.g. bathroom. If it is needed for taking shower, it is strongly recommended that the unit should be installed outside the bathroom in the house for safety reasons.
- ※ Failure to do so may result in carbon monoxide poisoning or fatal accidents and fire.
- This unit is an indoor installation type, please **do not** install it outdoors.
- ※ Rainwater will submerge or fire will be overwhelmed by the wind, causing the unit to malfunction and fire.
- Ventilation fan air suction volume requirement is 37.2m³/h per 1kW gas consumption total.
- ※ Please refer to right side data for the size of ventilation fan.
- Intake air hole require effective opening size 8.6cm² per 1kW total gas consumption.
- ※ According to the actual situation, the clearance of the window and the door may be counted as the area of the air supply port.
- ※ Refer right side data.

Ventilation fan dia, cm (inches)	Gas Consumption [kW]
15cm (6")	12.1 or less
20cm (8")	16.1 or less
25cm (10")	24.2 or less

Air Intake Vents	Flow factor	Effective area 91cm ² or more
Plastic or steel air vents	0.5	182cm ² or over
Wooden air vents	0.4	228cm ² or over
Perforated panel	0.3	304cm ² or over

Types of doors and windows	Effective opening area per 1m around and joint
Aluminium sash windows & doors	2cm ² or more
Steel door	10cm ² or more
Wooden door	20cm ² or more
Wooden window	5cm ² or more



WARNING

- Request for the professional qualified installers to carry out the installation.

Thank you very much for utilizing our product. Please read this manual carefully and follow the installation guide when installing this unit to ensure your own safety. Any failure, injury or fatal accidents caused by installation other than the method described in this 「construction manual」 is the responsibility of the contractor or installer. It is not covered under warranty even within the warranty period.



CAUTION

- Refer to the model sticker for indicating the LPG gas.
Check to ensure that it conforms.(Figure 1)
- ※ There is a fear of fire, incomplete combustion, abnormal ignition and cause of failure.
- Installation of the unit should follow local residential regulations.
- ※ Otherwise, it may caused fire or unexpected accident.
- To avoid fire, the safety distance for this unit is 45mm minimum from its sides to the wall, back 10mm minimum gap from the wall to its back, and 150mm or more from the exhaust hood to the ceiling (Figure 2)
- ※ There is a fear of fire. (Note: Each distance (mm) is minimum, it needs to be kept as it is or more)
- In addition, ensure that there is ample space for maintenance (front 600mm, side 200mm or more.)
- ※ Inadequate space may interfere inspection and repair work.
- **Do not** install the unit near flammable objects such as curtains and screen door.
- ※ This is a fear of fire. (Figure 3)
- **Do not** install the water heater in places that store or handle inflammables such as gasoline, benzene or adhesive.
- ※ There is a fear of fire.
- **Do not** install in rooms that use special chemicals such as, ammonia, sulfur, chlorine, ethylene compound, acids etc.
- ※ This may cause fire hazard. (Figure 4)
- **Do not** install near windy area or near the air outlet of air conditioner (Figure 5)
- ※ It may cause abnormal ignition by the wind, or flames and hot air overflowing from body unit air supply port, burning the walls and screen doors etc. on the back. Also, the flame may disappear or the incomplete combustion prevention device may operate. If the incomplete combustion prevention device repeatedly operates, it will not be able to use the unit.
- **Do not** install at a position where exhaust gas is emitted from the other cooking appliances (above the stove or the range) (Figure 6)
- ※ It may cause incomplete combustion or unit failure.
- **Do not** install near low heat resistant resin products such as lighting appliances. (Figure 7)
- ※ It may deform and discolor the plastic appliances.
- **Do not** install it where there is a danger of falling objects such as under the shelf.
- ※ There is a fear of fire.
- **Do not** apply force or drop the unit during installation.
- ※ Parts in the unit may be damaged, causing gas leak etc.
- **Do not** install at place with reverse winds from hood, wind directions, high temperature, high humidity, dust and oil dust.
- ※ It may cause fire from overflowing flames caused by wind, incomplete combustion and ignition failure.
- Approximately 5.7kg of mass will be added to the wall on which the unit installed. If there is not enough strength to support the weight of this unit, reinforcement is required.
- ※ Otherwise, after the installation is done, the unit may fall down.
- Do not channel the hot water heater to other places other than to the faucet.
- ※ This may cause burns or unit failure.

(Unit : mm)

<Figure 1>

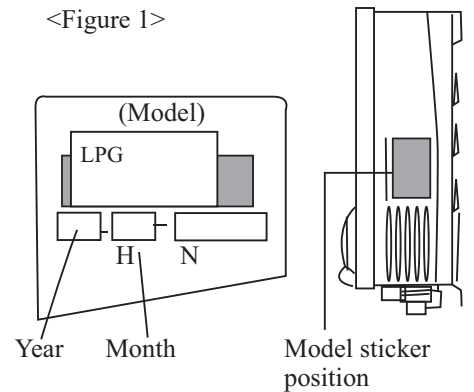

<Figure 2>

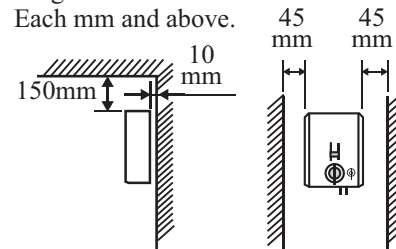

<Figure 3>



<Figure 4>



<Figure 5>

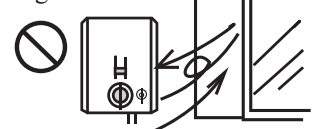

<Figure 6>

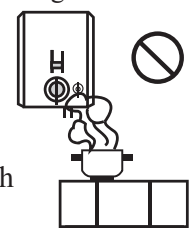

<Figure 7>

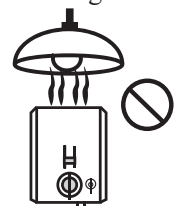

Installation Guideline

■ Gas piping construction

- ※ Gas piping construction should be done by a gas supplier or qualified installer.
- ※ Gas connecting port used is R1/2.
- ※ Piping by 15A(R1/2)
Examples of enhanced gas hose includes metal pipe or metal flexible pipe.

● Connection enhanced gas hose.

1. Place a spanner on the hexagon part of gas connection port and put the packing in the cap nut part of the reinforcement gas hose.
 2. Tighten the cap nut of the reinforced gas hose to the gas connection port
- ※ The bending radius of the reinforced gas hose should be 90mm or more.
 - ※ When tightening the cap nut, make sure the reinforced gas hose are no twisted.

< Reference >

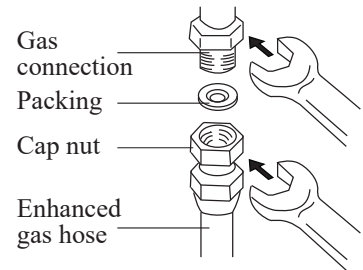

- ※ Installation of metal pipe or enhanced gas hose uses spanner put into hexagon shape connector for breakage prevention.
- ※ Always check for gas leaks after gas piping construction completed.



WARNING

Never use an uncertify gas hose to connect to gas pipe port. It may cause accident.

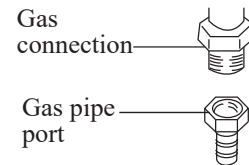

■ Confirmation after installation.

【Unit and its surroundings】

1. Is the distance to the material other than combustible material and the fire protection device sufficient ?
2. Does it hinder the daily use and inspection ?
3. Is the installation conditions of accessories parts correctly done ?

【Water supply piping, Hot water piping, Gas connection】

1. Before starting trial operation, check whether there is any misconnection of pipes or not.
 - ※ Is the water pipe or hot water pipe wrongly connect to the gas connection port ?
2. Is there any leakage from the pipe connection ports such as water supply, hot water supply and gas pipe ?
3. Will the lid of the dry battery case hit the piping of gas or not when opened ?
4. Whether the unit is wobbly or not, before and after performing each operation?

■ Trial operation (Test run)

1. After opening the main water plug valve, does water come out by opening the hot water lever on the faucet?
 2. Does water flow through the equipment and there is no water leakage? Is there any water leakage found at the connection part of the hot water supply?
 - ※ Pay attention to the connection area of hot water supply pipe and the unit.
 3. When opening the gas main plug valve, opening the main water plug valve and igniting it, is the hot water good?
 4. Does the temperature of the hot water change when turning the gas and water knob on the unit?
 5. When turning off the lever and extinguishing fire, the hot water stops and the fire of the burner disappears.
 6. Is there any abnormal noise during combustion? Are there any foul smell?
 7. After water has stopped flowing, close the water supply plug, remove the water filter at the water supply connection port, remove the dust on the water filter section, wipe it after cleaning, install it by inserting the water filter as how it was originally installed. (See "Water filter" on Pg.16). When trial run is over, please drain the water by closing each main valves unless you intend to use this unit immediately. Unless draining is done, foul smell may develop by the residual water in the unit. Moss may grow inside the unit and spoil it.
- Upon handling instruction manual to the customers, please ask the dealer to fill up the necessary details (such as Date of purchase, dealer name etc.) on the warranty card which is printed on the back cover of the instruction manual.
- ※ Request customer to keep this document.
- ※ The installation manual is enclosed in the instruction manual.



WARNING

Follow the instruction manual after completing installation work, explain the precautions on use and correct way of using the equipment to the customers.

※ Operating the unit in an incorrect manner may cause serious accidents.



WARRANTY

TERMS AND CONDITIONS OF WARRANTY :

This warranty promises to do free repair with the contents described in this manual. On Page 28, please contact our appointed dealer you purchased this unit from or call in to our company, if a malfunction occurs during the warranty period from the date this unit was purchased.

< Warranty target part • Warranty period >

1. Warranty coverage: The whole unit except the batteries
2. Warranty period: One year from the date of purchase

< Free repair provision >

1. We will provide repair, free-of-charge, in case of any breakdown during warranty period under normal use, follow user manual, caution stickers and so on. In addition, in case of repair to island or similar remote area, travelling costs will be charged to customer.
2. If the unit breaks down, please apply for free repair within warranty period by contacting our appointed dealer whom you purchased from or call in to our company. Present this warranty document at the time of repair.
3. In case of any home moving, please consult your dealer or our office in advance.
4. Some charges will incur in the following cases although the unit is still covered within its warranty period:-
 - i. Errors occurred as a result of not following the instruction manual or precaution labels, and breakdown or damage due to improper repair or remodeling.
 - ii. Failure or damage after purchase due to movements during installation carried out by non-qualified installer or unit being dropped.
 - iii. Failure caused by deforming architectural framework other than fault caused by the unit. Fading of paint by aging, phenomena caused by friction etc. due to daily use.
 - iv. Breakdown or damage by fire, salt damage, earthquake, wind/flood damage, lightning, soot, ash, acid rain, corrosive toxic gas, dust, abnormal weather, abnormal voltage/current, abnormal electromagnetic wave, abnormal frequency, mouse, birds, spiders, invasion insects etc. natural disasters and landslide.
 - v. Breakdown and damage due to inflow of foreign substances such as rust from the water pipe.
 - vi. Breakdown and damage that occurred when installed as an equipment on a vehicle or a ship.
 - vii. Failure, breakdown or damage caused by construction design or installation work other than the method provided in the installation manual.
 - viii. Business use (Coffee shop, Hair cut/dressing, restaurant, office etc.)
 - ix. Using a fuel other than the designated fuel indicated on the unit.
 - x. Failure caused by supplying hot spring water, well water, underground water.
 - xi. Breakdown by covered with flood water due to drainage failure.
 - xii. Warranty document is lost, damaged or unavailable.
 - xiii. In case there is no purchase data, customer name, store name and stamp. Or rewritten letter or wordings.

Distributed by:

Zenne Infinity Sdn. Bhd. (560198-X)

Lot 1863, Jalan Kolej, 43300 Seri Kembangan,
Selangor Darul Ehsan, Malaysia.

Tel: 03-8948 9088 Fax: 03-8948 9033

E-mail: zenne@zenne.com.my Website: www.zenne.com.my

28



WARRANTY REGISTRATION

(ONLY APPLICABLE FOR MALAYSIA)

WARRANTY CARD TO BE RETAINED BY CUSTOMER		(To be completed by dealer)	
Customer's Name :		Dealer's name and address (Stamp)	
Identity Card (IC) No :			
Address :			
Email Address :			
Tel No.	House :		
	Handphone :		
Product : Gas Small Type Water Heater			
Model : GQ-531WMY			
Serial No :			
Date of Purchase		Zenne Infinity Sdn. Bhd. (560198-X) Lot 1863, Jalan Kolej, 43300 Seri Kembangan, Selangor Darul Ehsan, Malaysia. Tel: 03-8948 9088 Fax: 03-8948 9033 E-mail: zenne@zenne.com.my Website: www.zenne.com.my	
<input type="text"/>	<input type="text"/>		<input type="text"/>
Date	Month		Year