

User Manual

Waterproof Weighing Indicator

GTW



© EXCELL PRECISION CO., LTD. 2018. All rights reserved worldwide.

The information contained herein is the property of EXCELL PRECISION CO., LTD. and is supplied without liability for errors or omissions. No part may be reproduced or used except as authorized by contract or other written permission. The copyright and the foregoing restriction on reproduction and use extend to all media in which the information may be embodied.



Table of Contents

PRECAUTIONS FOR USE 2

PREPARING TO USE THE SCALE..... 2

CHAPTER 1 INTRODUCTION 4

 1-1 FEATURES AND SPECIFICATIONS 4

 1-2 APPEARANCE..... 5

 1-3 DISPLAY DESCRIPTION 6

 1-4 ERROR MESSAGES 6

 1-5 KEYPAD FUNCTIONS DESCRIPTION 7

 1-6 POWER DESCRIPTION..... 7

CHAPTER 2 GENERAL OPERATION DESCRIPTION 8

 2-1 BACKLIGHT FUNCTION 8

 2-2 WEIGHING MODE 8

 2-2-1 Units Selection..... 8

 2-2-2 Check Weighing Mode 8

 2-2-3 Totalizing 10

 2-2-4 Zero Function 11

 2-2-5 Tare Function 11

 2-3 COUNTING FUNCTION 12

 2-3-1 Sampling..... 12

 2-3-2 Check Weighing 12

 2-3-3 Totalizing 12

CHAPTER 3 GENERAL FUNCTION SETTING..... 13

 3-1  ⇒ CHECK WEIGHING CONFIGURATIONS..... 14



 3-2  ⇒ RS-232 INTERFACE OUTPUT SETTING 15



 3-3  ⇒ EXIT FUNCTION SETTING MODE 21

 3-4  ⇒ INTERNAL VALUE DISPLAY MODE 21

 3-5  ⇒ G VALUE CALIBRATION 22

 3-6  ⇒ ID CODE SETTING..... 23

 3-7  ⇒ PRINT KEY () FUNCTION SETTING 24

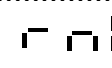
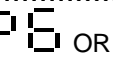
 3-8  ⇒ PRINTING ORDERS WHEN  IS SET AS  OR ..... 25

CHAPTER 4 WIRELESS CONNECTION INSTRUCTION..... 27

APPENDIX 1 RS-232 WIRING INSTRUCTION 32

APPENDIX 2 7-SEGMENT DISPLAY CHARACTERS 33

Thank for your purchasing of our EXCELL Weighing Scale. To guide you to use our product correctly, please read this User Manual carefully to extend the life of machine and to avoid error.

Precautions for Use

1. Please keep scale in a cool and dry place. Do not store under high temperatures.
2. Please keep the scale clean and free from insect infestation.
3. Avoid impacting with other items or overloaded with excessively heavy weights (The load must not exceed the maximum capacity of the scale).
4. If the scale is not going to be used for some time, please clean it and store it in a plastic bag in dry condition. A desiccant sachet may be included to prevent moisture from building up.
5. Do not mix different types of dry battery or mix used dry batteries with new dry batteries.
6. Please operate or charge the scale in an open area. Do not squeeze the power cord to avoid wire on fire.
7. Any suggestion is warmly welcome.

Preparing to Use the Scale

1. Locate the scale on a firm level surface free from vibrations for accurate weight readings. Adjust the four leveling feet to centre the leveling bubble on the scale.
2. Avoid hot sunshine directly on the scale or near the exhaust port of ventilating system.
3. Please use a separate power source plug, to avoid the disturbance of other electric appliance.
4. There should be no weight on the scale when power is turned on.
5. Commodity should be placed at the centre of platter when being weighed, and its size should not exceed the dimension of the platter.
6. Please warm the scale 15 ~ 20 minutes before using.
7. Please note that when  symbol appears on the screen, the scale needs to be charged.
8. Introduction of Storage Battery

Due to the storage battery adopt the advanced free-maintaining technique, customers need not to replenish electrolyte.

The scale should be recharged every 3 months to prevent failure of the internal rechargeable battery.

1. The battery should be charged for 8~10 hours.
2. The temperature of battery should below 45°C.

Maintaining

1. Please do not discharge with over-current when using the battery. Please charge the battery after discharging current.
2. Please take down the battery when the scale is not used for a long time or break the connection of cathode.
3. Do not short the battery terminals to check whether there is current. Please check whether the connection point is firm to guarantee good connection.
4. The battery should be replaced by specialized person. **No reverse-battery or the product will be damaged.**
 - a) Anode of battery should be connected with Anode of product battery (usually red cable)
 - b) Cathode of battery should be connected with Cathode of product battery (usually brown cable or black cable)
 - c) See the picture following

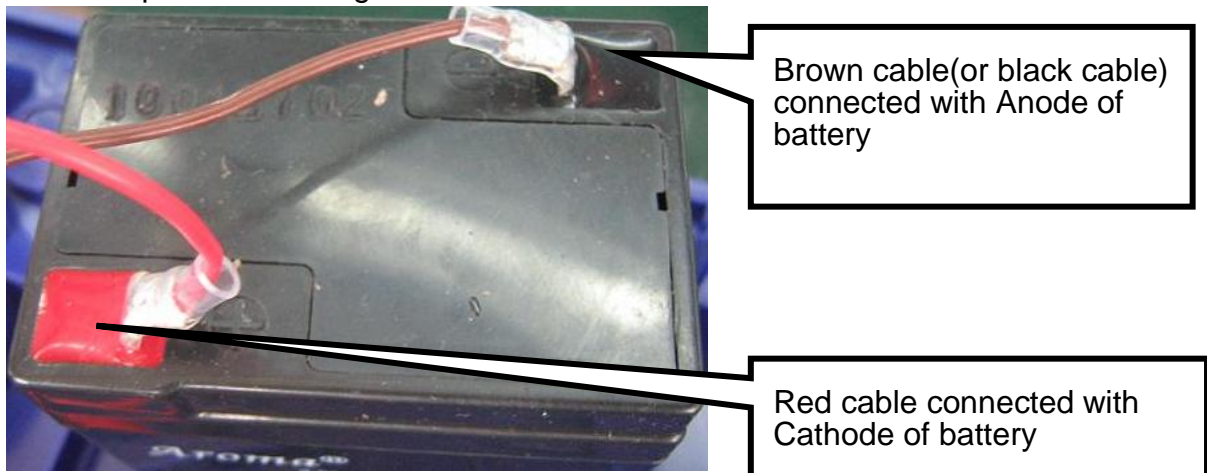

Safety warnings

1. The electrolyte of battery is caustic which causes metal, cotton, etc to corrode.
2. The hydrogen will be resolved when using or charging the battery and it will cause explosion when approaches fire.



No burning



Caution Corrosion



Warning explosion



Children faraway



Chapter 1 Introduction

1-1 Features and Specifications

Features:

- IP 68: mist-proof, waterproof and dustproof
- Up to 1/30,000 display resolution
- LCD display (Weight-6 digits); Full range tare; Auto zero tracking; Pre-tare
- High Speed 24bits AD; Display reading speed faster
- Faster weighing stability
- Zero key and Tare key react faster
- Preset weight or quantity; Weight accumulation
- Simple counting; Gross/Net indication; Hold function; Check mode Lo / Hi / OK
- Weight and quantity over-limit warning
- Pre-tare function
- Kilogram (kg) and pound (lb) weighing modes
- Stable sampling range setting function
- Built-in rechargeable battery
- Low power indication and auto power off
- U shape stand or Sleeve connecting stand selectable.
- RS-232 data-transfer interface

Options:

- Wireless for distance 100M available (SPP mode supported)
- Relay output (3 sets relay output)
- 1/30,000 with temperature compensation component more accurate and stable

Specifications:

Operating Temperature: -10°C ~ +40°C
Dimensions: 238 x 156 x 90mm (W x H x D)
Display: LCD, 6 Digits, 25 mm (Height), LED backlight





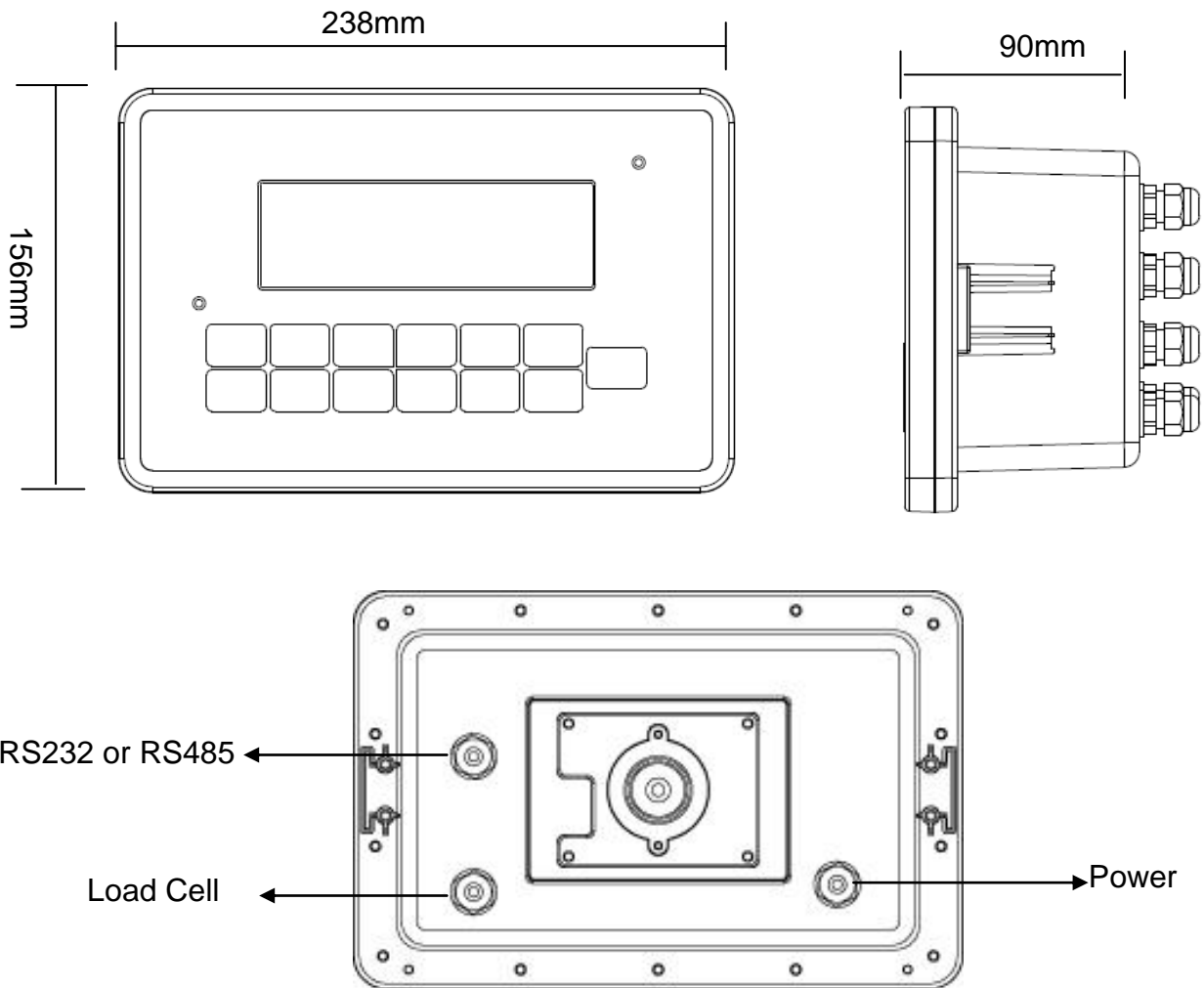



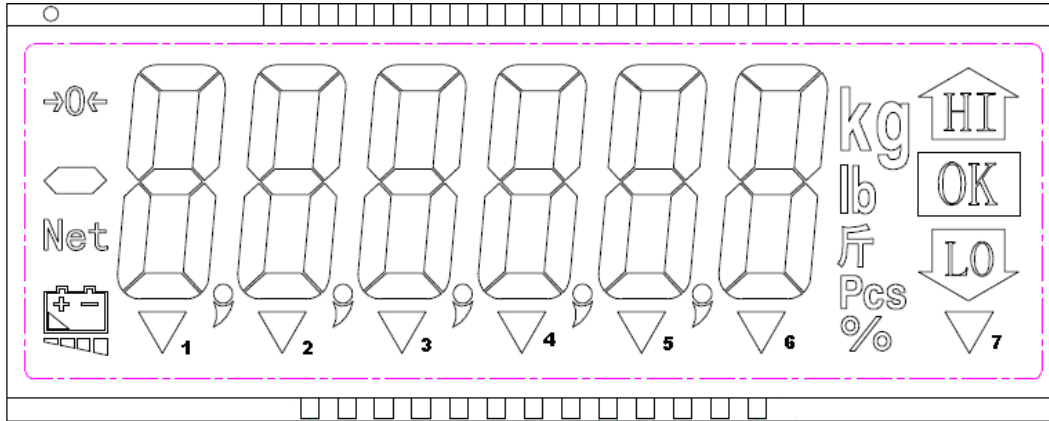









1-2 Appearance



1-3 Display Description











	:	High limit value
	:	OK value (The value between HI and LO limit value)
	:	Low limit value
	:	“Zero” indication
	:	“Net weight” indication
	:	“Low battery power” indication
	:	“Stable” indication
	:	“Pre-tare mode” indication
	:	“Accumulation mode” indication
	:	“Samples insufficient” indication
	:	“Unit weight insufficient” indication
	:	“kg” unit
	:	“lb” unit
	:	No function
	:	Counting mode
	:	Percent indication









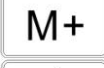

Changes of “Range” indication mode

The indicator with 2-segment specification:  6 is Range 1  5 is Range 2

1-4 Error Messages

-  ⇒ Weight exceed 9d of maximum capacity. (d=division)
-  ⇒ Zero value after power on is over +10% FS.
-  ⇒ Zero value after power on is less than -10% FS.
-  ⇒ Unstable zero return, unstable over 10 sec. Press  to leave E4.
-  ⇒ Zero is too high when calibrating. (over internal value 350,000)
-  ⇒ Zero is too low when calibrating. (under internal value 80,000)
-  ⇒ If the negative weight is over 20 divisions and there is no T or PT, the display shows “-----”

1-5 Keypad Functions Description

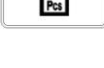
	: Press this key to power on or power off the scale
	: Press this key to select the required unit from the preset units.
	: Press this key to preset the weight and quantity.
	: Press this key to accumulate the weight value or others.
	: Press this key to tare (deduct the container weight)
	: Press this key to preset tare value.
	: Press this key to recall the totalization value, preset value and pre-tare value.
	: Press this key to clear the totalization value, preset value and pre-tare value.
	: Press this key to zero the scale.
	: Press this key to print the total data and to confirm.
	: Press this key to input the numbers (0 ~ 9) and to light up the backlight.
	: Press this key to go into counting mode
	: Press this key to sample

1-6 Power Description

Power Selection

1. 6 V / 4 Ah Rechargeable batteries
2. 110 V / 220 V $\pm 15\%$ AC

Power Consumption

(Indicator + Load Cell+ no backlight)	About 25 mA
(Indicator + Load Cell+ backlight)	About 33 mA
(Indicator+ Load Cell+ Backlight+ wireless)	About 65 mA

Low Power Alarm

Please note when the () symbol keeps flashing on the left down corner of the display, the batteries should be recharged.

 The scale will turn off automatically after a few hours when the low battery warning symbol shows up. The scale must be fully recharged, before operating again.

 Please recharge at once when the symbol  shows in order to keep the weight accuracy.

Chapter 2 General Operation Description

2-1 Backlight Function

Press  key to select the display backlight mode:

bl. Auto ⇒ “Auto Backlight” mode. When the weight is over 10d or any key is pressed, the display backlight will be switched on. When the weight returns to zero (the weight on platform is less than 10d), the display backlight will switch off after 10 seconds.

bl. on ⇒ Display backlight is on all the time.

bl. off ⇒ Display backlight is off.

2-2 Weighing Mode

2-2-1 Units Selection

1. After indicator is turned on, use  key to select a unit from kg, lb, tael or viss, as the screen indicated.
2. The selected unit will be memorized when you turn the indicator off. And the memorized unit will appear after you turn on the indicator next time.





2-2-2 Check Weighing Mode

1. Preset “High limit”, “Low limit” and “Beeper value” operation

Use  and  key to preset values.

For example:





Preset “Low limit” (Low limit >10d) *e.g. Low limit = 20 kg*

Press  key	the display shows	0 - - . - - L
Press  key 1 time	the display shows	0 0 - . - - L
Press  key 2 times	the display shows	0 2 - . - - L
Press  key 4 times	the display shows	0 2 0.00 0

Preset “High limit” (High limit ≥ Low limit) *e.g. High limit = 25 kg*

Press  key 1 time	the display shows	0 - - . - - H
Press  key 1 time	the display shows	0 0 - . - - H
Press  key 2 times	the display shows	0 2 - . - - H
Press  key 1 time	the display shows	0 2 0 - . - - H
Press  key 5 times	the display shows	0 2 5 - . - - H
Press  key 3 times	the display shows	0 2 5.00 0

Preset “Beeper value” (Refer to **Note**) *e.g. Beeper value = 22*

Press		key 1 time	the display shows	$\geq 0 \leq - b$
Press		key 2 times	the display shows	$\geq 2 \leq - b$
Press		key 1 time	the display shows	$2 \geq 0 \leq b$
Press		key 2 times	the display shows	$2 \geq 2 \leq b$
Press		key 1 times	the display shows	0.000

 Preset Single point (preset low limit only):

After “preset low limit” procedures is completed and the display shows $\geq 0 \leq - - - - H$, then press  key again, the display shows 0.000. This means that the “preset single point” procedure is completed.

NOTE

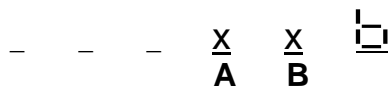

- A** Setting for the status that LCD is on and the beeper beep:
 0 = when stable, the beeper beeps and LCD is on.
 1 = when stable, the beeper beeps; whether stable or not, LCD is on.
 2 = whether stable or not, the beeper beeps and LCD is on.
 3 = open warning device: when the weight is higher than HI value and the weight is stable, LCD is on and Relay Card open.
- B** Setting for the beep status:
 0 = No beep
 1 = OK (when the weight is over Low Limit & under or equal to High Limit.), the beeper beeps.
 2 = When the weight is under or equal to Low Limit & over High Limit, the beeper beeps.

 Under Status in Preset Low Limit (preset single point only)

The BEEP, LCD mode should be fixed as follows:

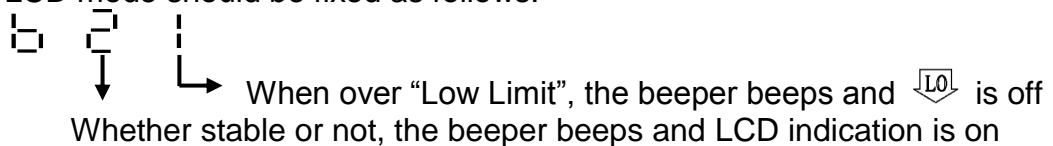

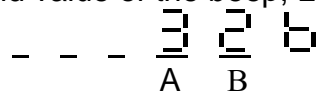

 Warning device setting

Set HI value and value of the beep, LCD mode should be fixed as follows:



When the weight equals to HI value, Relay Card open and the weight is accumulated. Press  key to dismiss the warning sound and the range of accumulated weight is [000.000]~[999999].

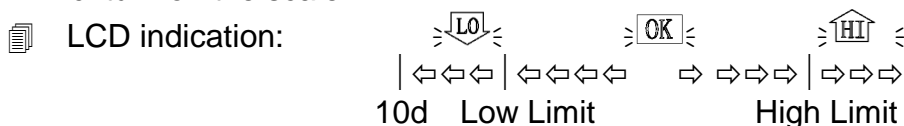

 Clear warning accumulation

- ◆ Press  key first and then press  key to clear all accumulated data.
- ◆ Accumulated data is cleared automatically under following conditions
 - a. when shift among weight mode, counting mode and warning accumulation mode.
 - b. when shift the units
 - c. turn off the scale









◆ To exit preset mode, please press  key.

2. Recall Check-weighing Values

- Press  key then press  key ⇒ Recall “Low limit value”
Then press  key again ⇒ Recall “High limit value”
Then press  key again ⇒ Recall “Beeper value”
Then press  key again ⇒ Back to the beginning



3. Clearing Check-weighing Values

- Press  key then press  key, and then press  key ⇒ Recall “Low limit value”. Then press  key again ⇒ Clear “High limit value” and “Beeper value”
Press  key then press  key 6 times continuously ⇒ Clear all values.

2-2-3 Totalizing

1. Weight Totalizing

Place goods on the platter, after stable and press  key to save the weight value. Then the display shows the total number of additions and the totalized weight value. And the (M+) indication “▼” will flash on the display. The indicator will recover to show the weight value of the goods on the platter after 3 seconds and the (M+) indication “▼” is on.



 The indicator allows the next totalizing operation, even when the weight value does not return back to zero. The  key is functional, when the weight value changes by more than 10d. The indicator will save the totalized weight value after the weight is stable.

 The indicator can totalize positive or negative weight but can't do both at the same time. The totalized weight store must be reset to zero before it is possible to select positive or negative totalizing mode.

 The totalizing function can be used up to a maximum of 9999 times before it must be reset. The totalizing display is limited to 6 digits maximum.

 When totalizing, RS-232 will also output. (Refer to F5 setting)

2. Clear Totalized Weight Values



- ◆ Press  then  key to clear all totalized weight values.
- ◆ When changing between weighing and counting mode, or selecting weighing unit, the indicator will automatically clear all the totalized weight values.
- ◆ The indicators will automatically clear all the totalized weight values after turning on.

3. Recall Totalized Weight Values

Press  key to display the total number of additions and the totalized weight value. And the (M+) indication “▼” will flash on the display. The indicator will return to the weighing mode after 3 seconds.

The indicator will not display the negative sign “-” for negative totalized weight values when recalling a totalized weight value, but when printing, the negative sign “-” will be printed out (transmitted serially) for each negative weight and negative totalized weight.

2-2-4 Zero Function

Press  key to re-zero the display with no load on the platter. When zero is set, the () symbol will be displayed.

2-2-5 Tare Function

1. When the weight of the container is unknown ()



❶ Place the container on the platter, after stable and press  key, the weight value returns to zero and net indication (**Net**) is on.

❷ Place goods into the container, then the indicator shows the net weight of goods.

❸ Clear tare value

When removing the container and goods, the display shows the negative weight value of the container. Then press  key to clear tare value. The indicator returns to zero and net indication (**Net**) is on.

❹ Recall tare value



Press  then  key \Rightarrow the display shows tare value

Multiple tare operation \Rightarrow Users can continuously increase or decrease the tare value by pressing the  key.

The total tare value (tare value + pre-set tare value) can equal the full capacity of the indicator.



2. When the weight of the container is known ()

❶ Press  key and the display shows $\geq 0 \leq - - . - P$.

Use  and  keys to input weight value of the container. After finishing the procedures, the net indication (**Net**) and pretare indication “ \blacktriangledown ” is on.



❷ Place goods into the container, then the indicator shows the net weight of goods.

❸ Clear pretare value

Press  then  key, and then press  key to clear pretare value.

When the indicator returns to zero, net indication (**Net**) and pretare indication “ \blacktriangledown ” are off.

❹ Recall pretare value





Press  then  key \Rightarrow the display shows pretare value

In Tare mode, the Preset tare function is disabled.

 The indicators with two weighing ranges can NOT pre-set the tare value larger than the first weighing range. For example: a 30 kg indicator is set by two weighing ranges. The first range is 0 to 15 kg, and the second range is 15 to 30 kg. The pre-set tare value can not be larger than 15 kg.

2-3 Counting Function

2-3-1 Sampling

- ① Press  key to select sample quantity from 10, 20, 50, 100 and the display shows 10, 20, 50, 100 accordingly.
- ② Select sample quantity and then place samples on the platter, and then press  key, the display shows “SAMPLE”.
After stable, the scale enters into counting mode and the display shows sample quantity.
 - ◆ Sample Too Small () ⇒ Sample is less than 20 divisions.
 - ◆ Unit Weight Too Small () ⇒ Unit weight is less than 0.2 division.
(0.1 d for Brazil regulation)

 When sampling, the above two symbols indications are on. Under such conditions, the scale can still work, but may result in lower count precision.

 When using 2-segment weighing mode, the above two symbol indications change to Range 2 and Range 1 and the two symbol indications are off.

2-3-2 Check Weighing

Refer to the operation of check weighing in weighing function.

2-3-3 Totalizing

Refer to the operation of totalizing in weighing function.

Chapter 3 General Function Setting

- ◆ Switch on the scale. While the scale is counting down to zero, press and hold **→0←** key until the display shows the software program version number **02018**. Release the **→0←** key, the scale enters into the configuration setting mode and **F0** is showed on the display.

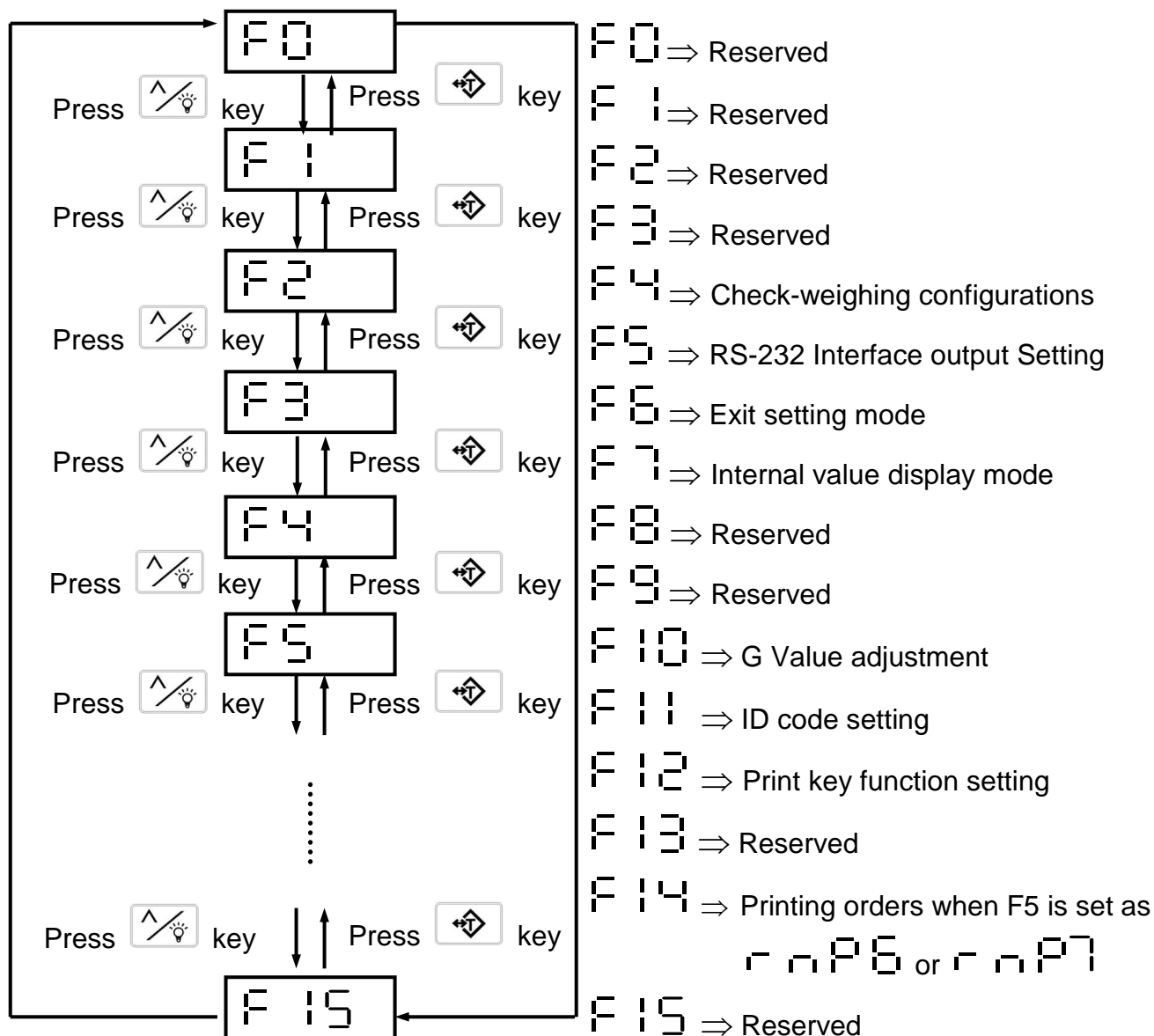

3-1 F4 ⇒ Check Weighing Configurations

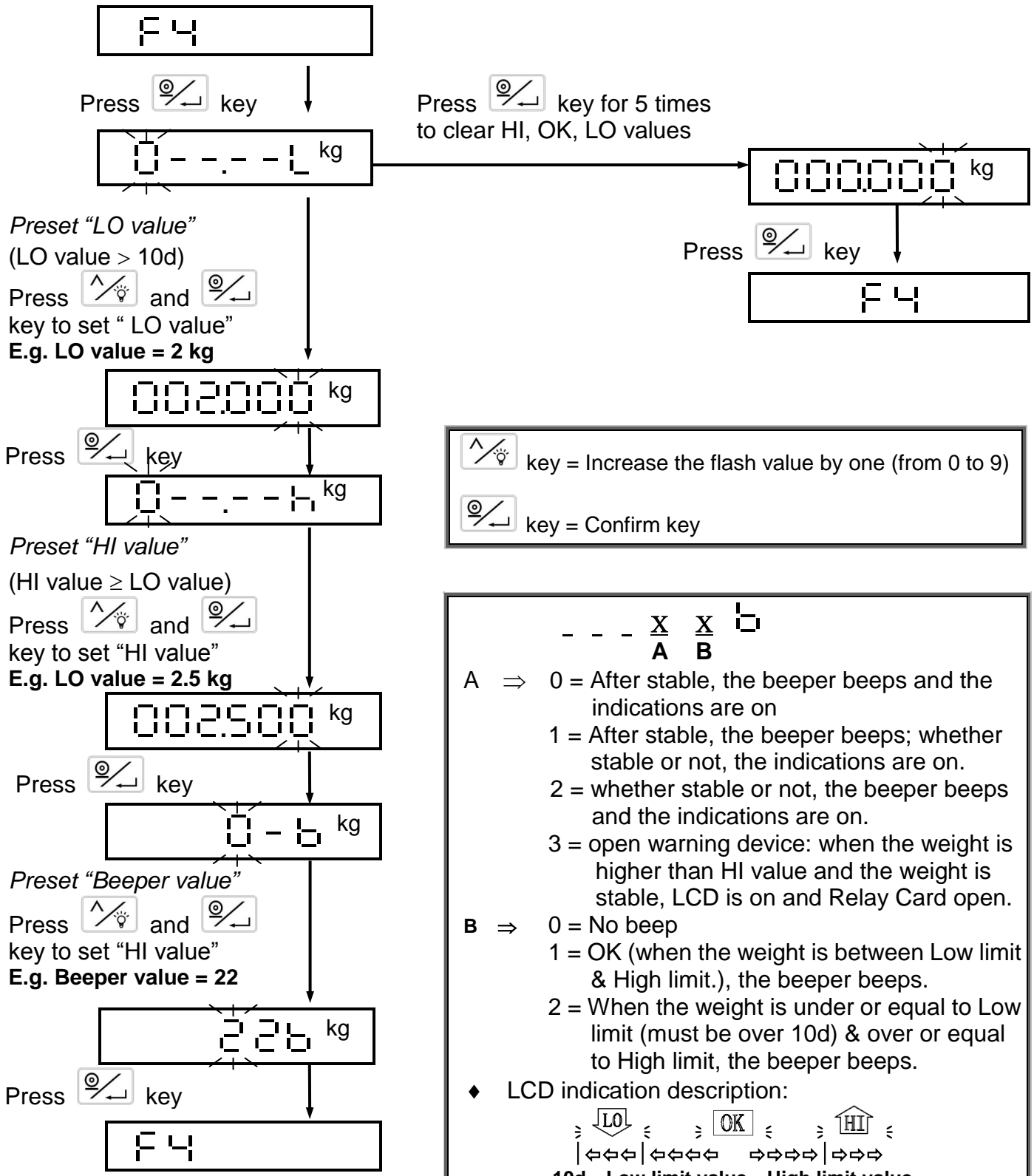

◆ If hold mode is set, accessing to F4 is denied.

Press or key to select F4 function ⇒ the display shows F4





3-2 F5 ⇒ RS-232 Interface Output Setting



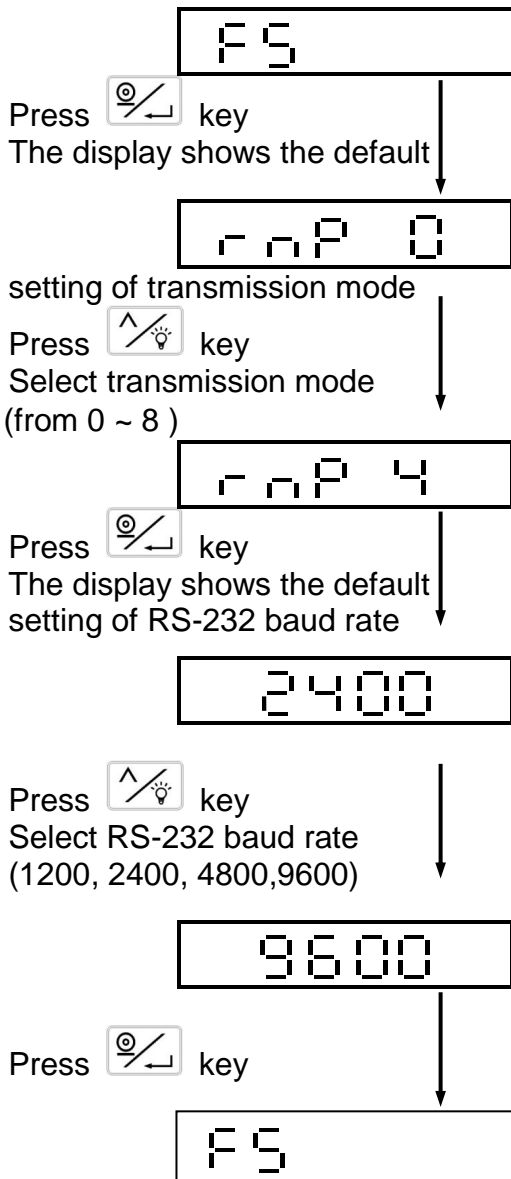



Make J1、J3 on RS232 short circuit, when connecting to computer.

Press  or  key to select F5 function ⇒ the display shows F5



 key = Increase the flash value by one (from 0 to 8) or selecting baud rate from 1200, 2400,4800 and 9600(default setting).

 key =Confirm key

- r n P 0 ⇒ No transmission
 - r n P 1 ⇒ Stable transmission *
 - r n P 2 ⇒ Continuous transmission *
 - r n P 3 ⇒ Press  key to transmit in simple mode. *
 - r n P 4 ⇒ Press  key to transmit in complete mode.*
 - r n P 5 ⇒ Stable transmission in totalizing mode.
The format is as same as r n P 3 *
 - r n P 6 ⇒ Free format. Please refer to F 14.
 - r n P 7 ⇒ Free format. Please refer to F 14.
 - r n P 8 ⇒ Press  key to transmit.
The format is as same as r n P 1 and r n P 2. *
 - r n P 9 ⇒ Continuous transmission, specific format *
 - r n P 10 ⇒  or  key transmit specific format *
- * : RS-232 is open
-  For Brazil approval models, if the unit weight is less than 0.1d, RS232 function close.

RS-232 Interface Format

I . Mode: UART Signal of EIA-RS0232 C

II . Format :

1. Baud rate : 1 200, 2 400, 4 800, 9 600 bits/second
2. Data bits : 8 bits
3. Parity bit : None
4. Stop bits : 1 bit
5. Code : ASCII (Exchange code of American standard)

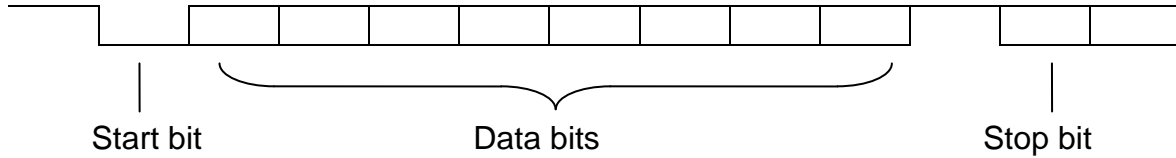

RS-232 Data Format

Stable transmission ($\overline{\text{r n P i}}$), Continuous transmission ($\overline{\text{r n P e}}$),
 Press  key to transmit ($\overline{\text{r n P 8}}$)

(1) gram as weight unit

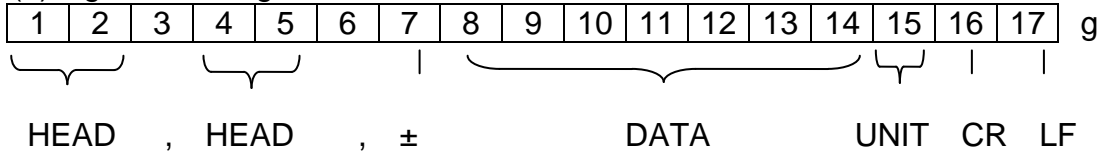

(2) kg or lb as weight unit

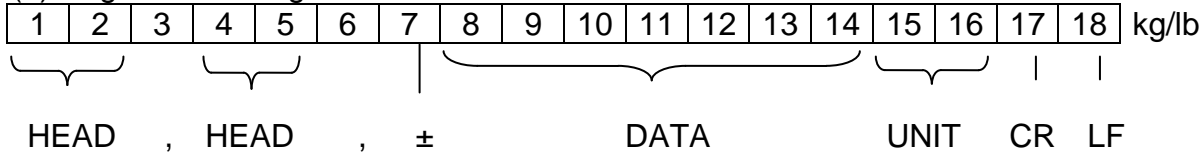



HEAD1 (2 BYTES)		HEAD2 (2 BYTES)	
OL	- Overload , Under load	TR	- TARE Mode
ST	- Display is Stable	NT	- NET Mode
US	- Display is Unstable	GS	- GROSS Mode

DATA (7 or 8 BYTE)

2B (HEX) = “ + ” (PLUS)

2D (HEX) = “ - ” (MINUS)

2E (HEX) = “ . ” (DECIMAL POINT)

UNIT (2 、 3 or 4 BYTE)

kg = 6B (HEX) ; 67 (HEX)

lb = 6C (HEX) ; 62 (HEX)

tl.T = 74 (HEX) ; 6C (HEX) ; 2E (HEX) ; 54 (HEX)

hkg = 68 (HEX) ; 67 (HEX)

viss = 76 (HEX) ; 69 (HEX) ; 73 (HEX) ; 73 (HEX)

Transmission examples:

Data format for RS-232 continuous transmission are as below:

1. The gross weight (+0.876 kg) shows as below, after stable: (no tare or pre-tare mode)

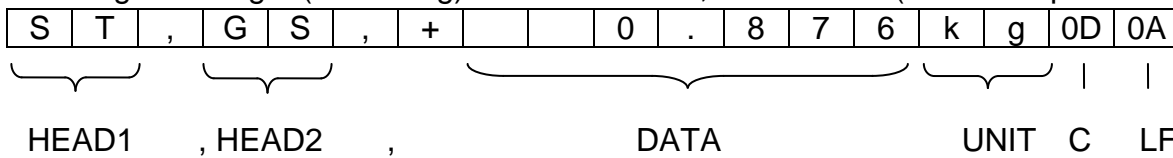

2. The net weight (-1.568 lb) shows as below without weight stability: (under tare or pre-tare mode)

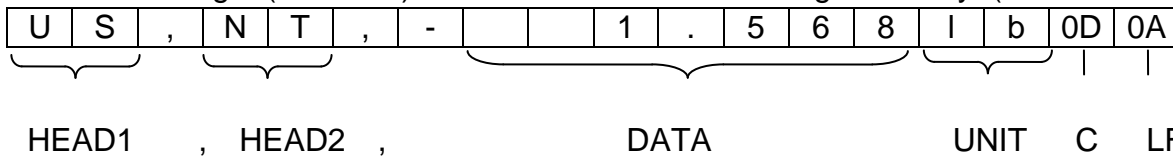



Press key to transmit (simple mode)

S/N WT/UNIT (kg / lb)

0001 1.0000

➔ Press or key

0002 1.0000

➔ Press or key

0003 1.0000

➔ Press or key

0004 1.0000

➔ Press or key

0005 1.0000

➔ Press or key

0005 5.0000

➔ Press twice to print TOTAL

Press key to transmit (complete mode)

TICKETS NO. 0001
G 1.000kg
T 0.000kg
N 1.000kg
(3 blank lines)

➔ Press or key

TICKETS NO. 0002
G 1.000kg
T 0.000kg
N 1.000kg
(3 blank lines)

➔ Press or key

TICKETS NO. 0003
G 1.000kg
T 0.000kg
N 1.000kg
(3 blank lines)

➔ Press or key





TOTAL NUMBER
OF TICKETS 0003
TOTAL
NET 3.000kg
(3 blank lines)



➔ Press twice to print TOTAL

G = GROSS T = TARE N = NET

Stable Transmission (totalizing mode)

S/N WT/UNIT (kg / lb)

0001	1.0000	 The scale is stable
0002	1.0000	 The scale is stable
0003	1.0000	 The scale is stable
0004	1.0000	 The scale is stable
0005	1.0000	 The scale is stable

0005	5.0000	 Press  twice to print TOTAL

RS232 output format in HOLD MODE

Please set    in  .

If there is only RS-232, press  to print out the HOLD value on the display.

Continuous Transmission (specific form for Brazil models)

The print out is as below:

If display shows 70.15kg, the RS-232 export is 51.07000

If display shows -70.15kg, the RS-232 export is 51.0700-

If display OL, RS-232 print nothing.

M+ or key Transmission (specific form)

Totalization print form

F	R	"	W	T	3	N	"	<LF>										
?	<LF>																	
G	G	,	G	G	G	<LF>												
T	T	,	T	T	T	<LF>												
PT	PT	,	PT	PT	PT	<LF>												
N	N	,	N	N	N	<LF>												
pcs	pcs	pcs	pcs	pcs	pcs	<LF>												
n	n	n	n	n	n	t	t	t	t	t	pcs	pcs	pcs	pcs	pcs	pcs	<LF>	
p	1	,	1	<LF>														

For example:

PT 0.3KG
T 0.7KG
G 1.2KG
N 0.2KG
PCS 20



Then the printing form is:

FR"WT3N "

?

1,200

0,700

0,300

0,200

20

000020001000000020

P1,1

Use  +  key or  key twice to clear the format

Then, form of clearing the printing:

F	R	"	5				"	<LF>										
?	<LF>																	
TN	TN	TN	TN	TN	TN	<LF>												
TW	TW	TW	TW	TW	TW	<LF>												
TA	TA	TA	TA	TA	TA	<LF>												
tn	tn	tn	tn	tn	tn	<LF>												
tn	tn	tn	tn	tn	tn	tw	tw	tw	tw	tw	tw	ta	ta	ta	ta	ta	ta	<LF>
p	1	,	1	<LF>														

FR"520T "

?

1

0,200

20

000001000200000020



P1,1

3-3 F 6 ⇒ Exit Function Setting Mode

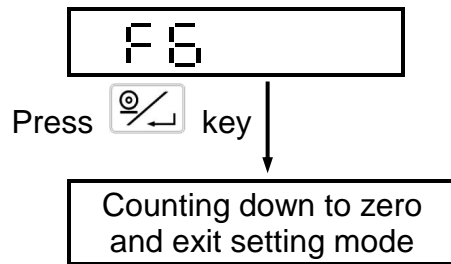
Press  or  key to select F 6 function ⇒ the display shows F 6



3-4 F 7 ⇒ Internal Value Display Mode

Press  or  key to select F 7 function ⇒ the display shows F 7

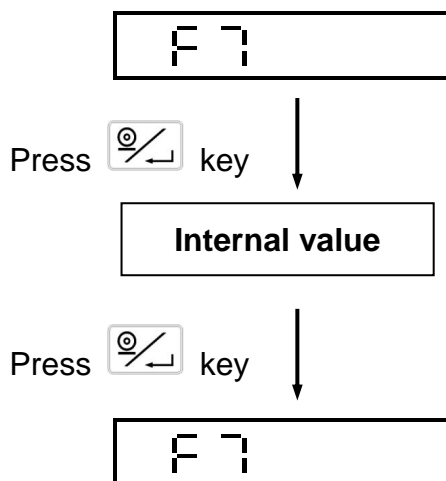

3-5 F 10 ⇒ G value Calibration

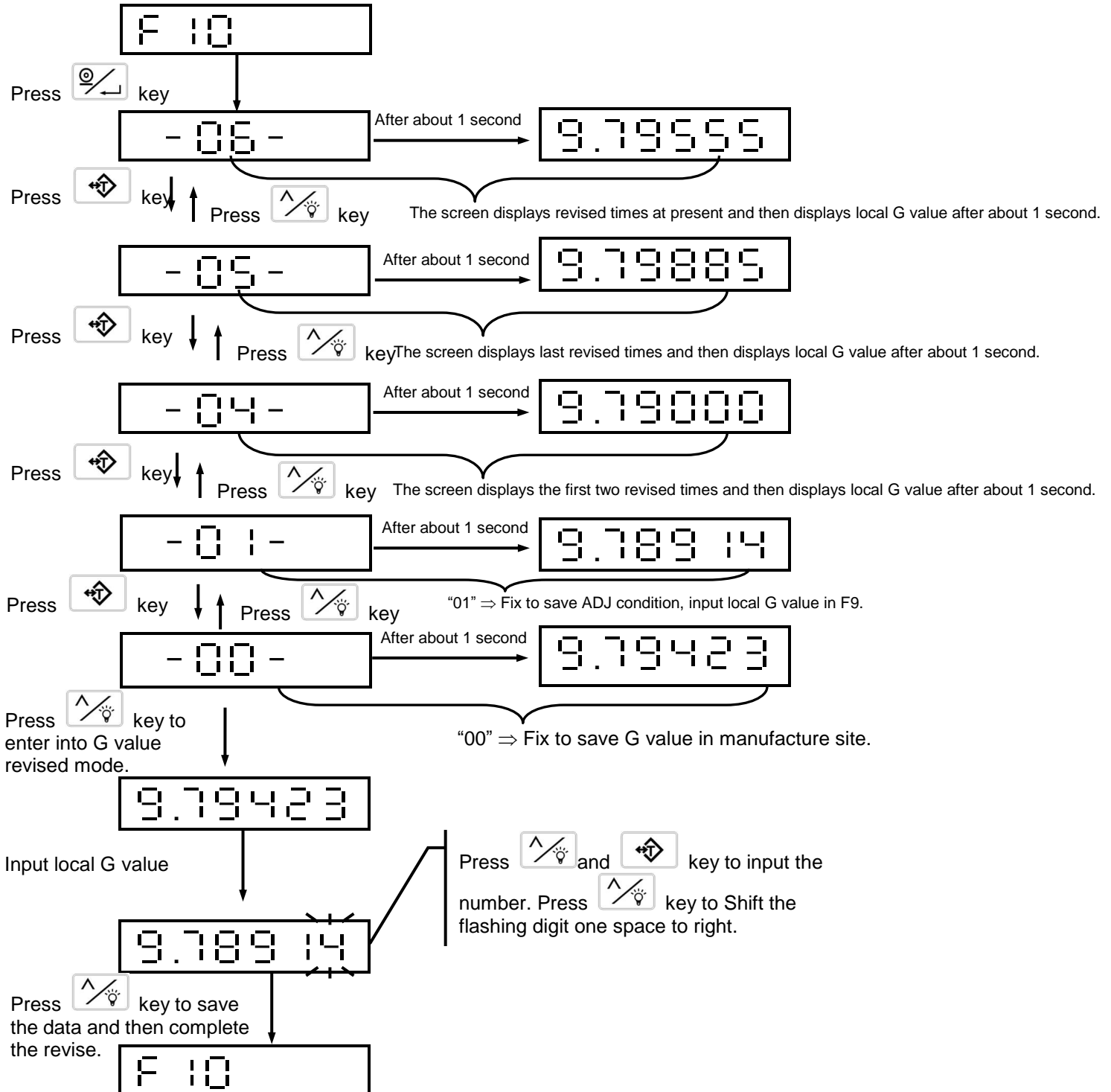

Press key or key to select F 10 function. ⇒ The display shows F 10.

You can input at most 9 sets of G value's data. The historic data can be found out and not to be revised.



3-6 F I I ⇒ ID Code Setting

(Use must be in coordination with F 5 , r n P 1 , 2 , 8)

Press  key or  key to select F I I function ⇒ the display shows F I I

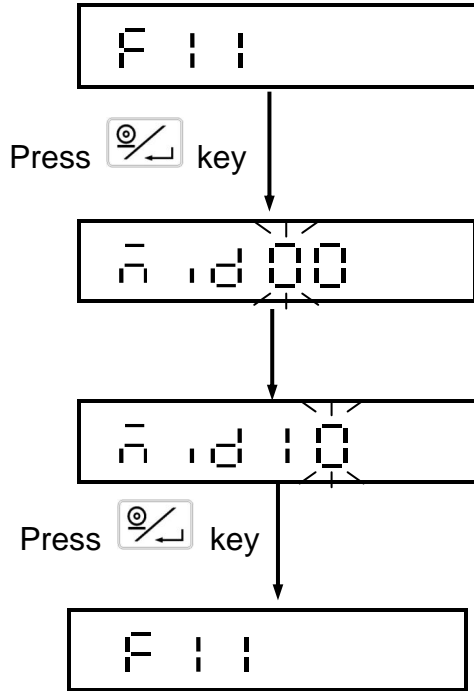

Machine ID code setting:

Press  and  to set 01 ~ 99.

Default setting: 00

Machine ID code setting:

(1) "00": RS-232 does not transmit Machine ID.

(2) "01~99": RS-232 transmits Machine ID.

RS232 DATA FORMAT

Stable transmission (r n P 1), Continuous transmission (r n P 2),

Press  key to transmit (r n P 8)

1. e.g. Machine ID code is 10.

The gross weight (+0.876 kg) shows as below, after stable: (no tare or pre-tare mode)

1	0	S	T	,	G	S	,	+	0	0	0	.	8	7	6	k	g	0D	0A
ID		HEAD1		,	HEAD2		,	DATA							UNIT		C	LF	

2. e.g. Machine ID code is 00. (Not using Machine ID function.)

The net weight (-1.568 lb) shows as below without weight stability: (under tare or pre-tare mode)

U	S	,	N	T	,	-	0	0	1	.	5	6	8	l	b	0D	0A
HEAD1			,	HEAD2		,	DATA							UNIT		C	LF

3-7 F 1 2 ⇒ Print Key () Function Setting

Press  key or  key to select F 1 2 function ⇒ the display shows F 1 2

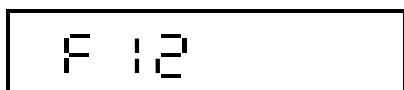

Press  key ↓

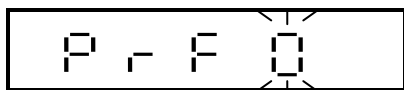

Press  key ↓

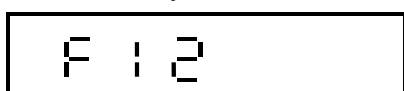

Press  and  to set 0 ~ 2.

Default setting: 0

P r F 0 ⇒ If weight variation is beyond $\pm 1d \sim \pm 10d$,  has totalization function. Or it is print function (d=division)

P r F 1 ⇒  key has print function (no totalization function)

P r F 2 ⇒  key has print function, if current weight is within the lower and upper limits. (no totalization function)

3-8 F14 ⇒ Printing Orders when F5 is set as r n P 5 or r n P 7

No.0	No print.
No.1	TICKET NO.
No.2	G
No.3	T
No.4	PT
No.5	N
No.6	P/N
No.7	S/N
No.8	No print
No.9	No print



F14 Contains a 9-digit code

If F14 is set as 8900000000



① The format of r n P 5 is as following

S/N WT/UNIT (kg / lb)



0001 1.0000

⇒ Press  key or Press  key



0002 1.0000

⇒ Press  key or Press  key



0003 1.0000

⇒ Press  key or Press  key

0004 1.0000

⇒ Press  key or Press  key

0005 1.0000

⇒ Press  key or Press  key

0005 5.0000

⇒ Press  key twice to print the total

② The format of r n P 7 : RS-232 print nothing



If F14 is set as 096 123 450

① The format of is as following

P/N 012345678901
 TICKET NO. 0001
 G 75.01kg
 T 0.00kg
 PT 0.00kg
 N 75.01kg
 S/N WT/UNIT (kg / lb)

0001	1.0000	➡ Press key or Press key
0002	1.0000	➡ Press key or Press key
0003	1.0000	➡ Press key or Press key
0004	1.0000	➡ Press key or Press key
0005	1.0000	➡ Press key or Press key

0005	5.0000	➡ Press key twice to print the total.

② The format of is as following

P/N 012345678901
 TICKET NO. 0001
 G 75.01kg
 T 0.00kg
 PT 0.00kg
 N 75.01kg

➡ Press or key

TOTAL NUMBER
 OF TICKETS 0001
 TOTAL
 NET 0.499kg

➡ Press key twice to print the total

Chapter 4 Wireless Connection Instruction (Option)

Step 1: Connect to your device

1. Enable Wireless on your computer. Right-click on the  icon of the bottom-right corner on the taskbar, highlight “**New Connection**” and left click.

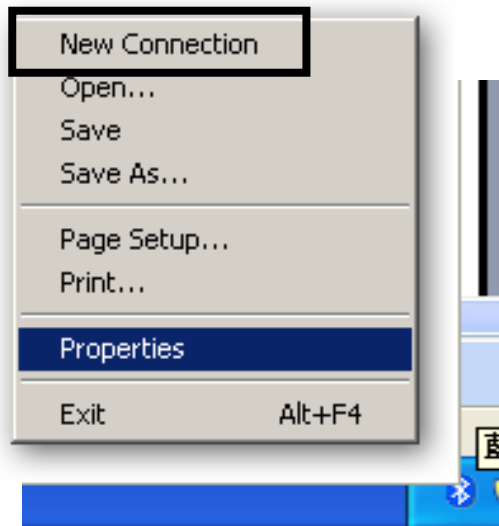

Due to the different bluetooth supplier software could be installed, the setting dialogs shown below are just for reference.

2. Check “**My device is set up and ready to be found**” in the dialogue box.



3. If the device is ready, the device names **Device-C1** or **C2** will be found. Double-click on Device-C1 or Device-C2.



4. Circle “**Let me choose my own passkey**”, input the passkey “111111” and click “**Next >**” button

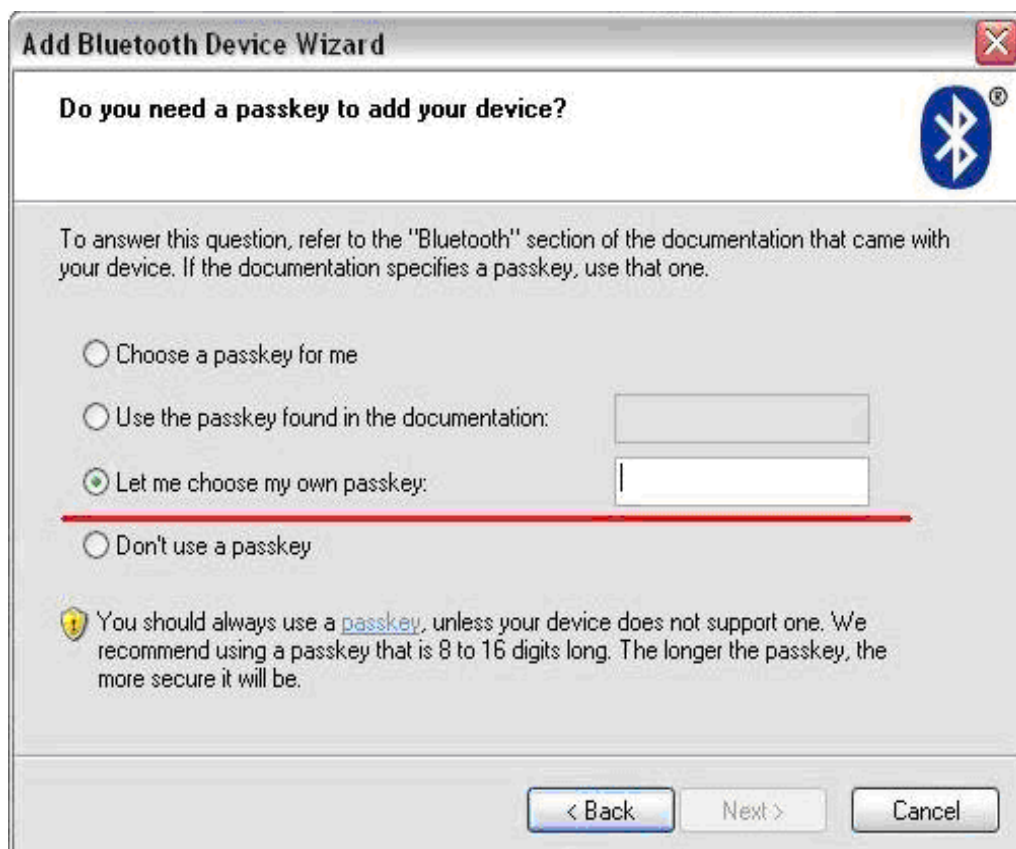

5. Device is added so far. Please disconnect COM port and click “**Finish.**”

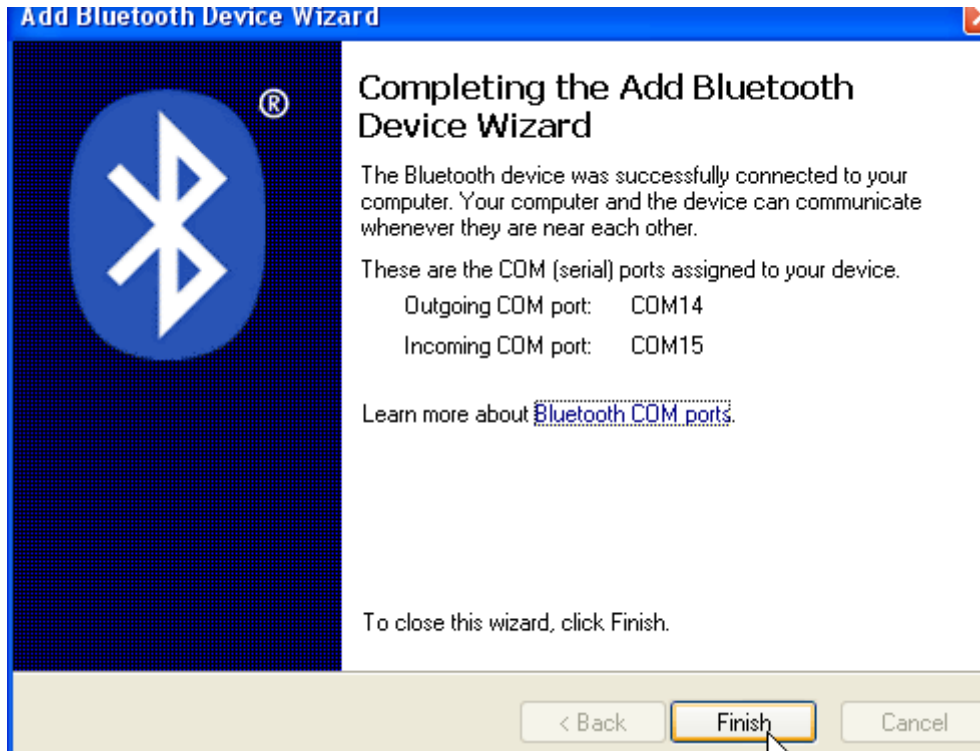

Step 2: Connection test

To test the connection, use HyperTerminal recommended in Windows XP

1. go “START” → “All programs” → “Accessories” → “Communications” → “HyperTerminal”

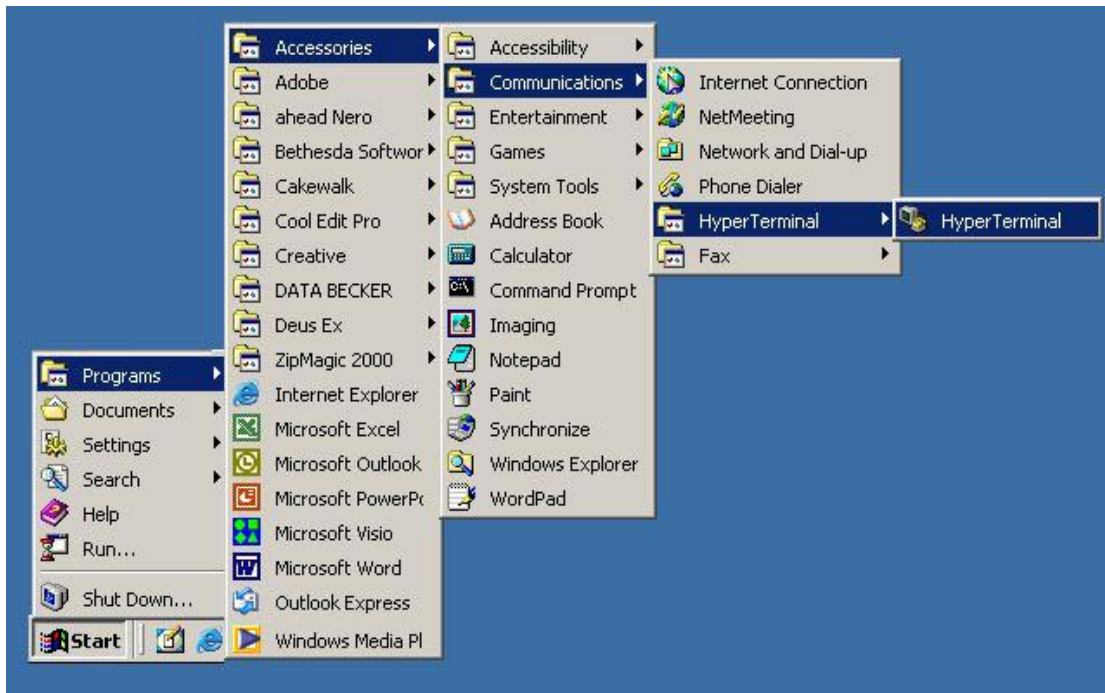

2. Key in a name and select icon, then press “OK.”

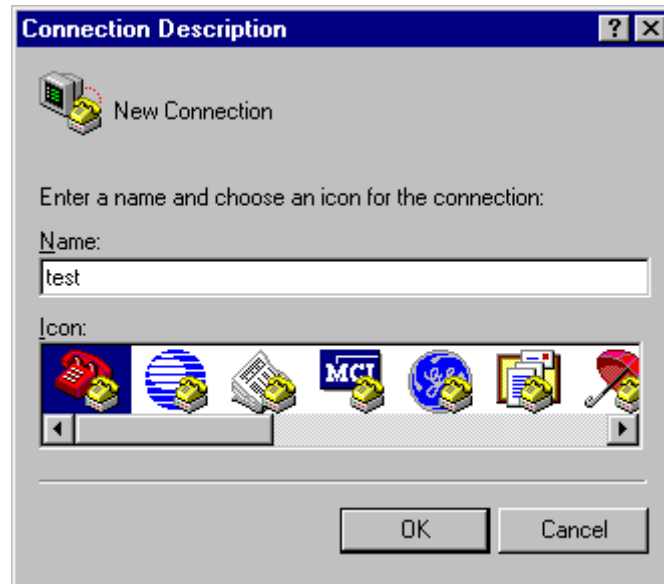

3. After select the COM port referred by step 1 point 5 and click “OK.”



4. Click “File” → “Properties”

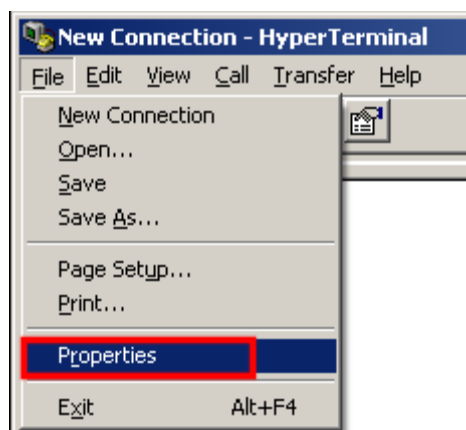

5. Select “**settings**” from the menu, and click “**ASCII setup**” on the bottom of the box.

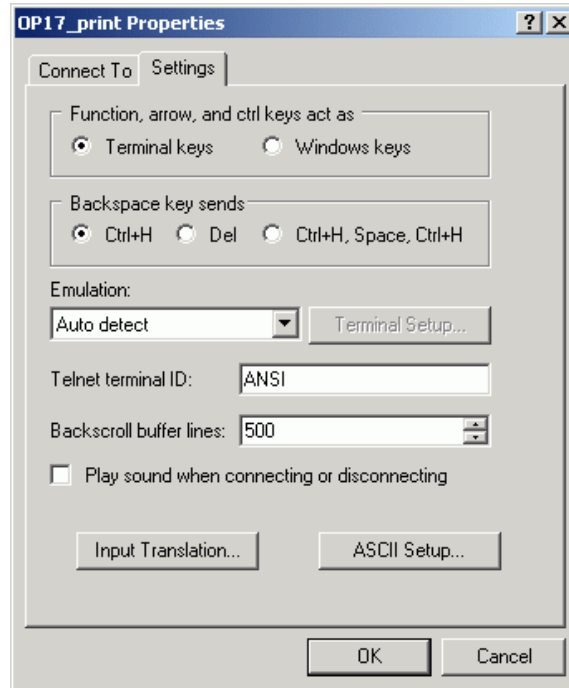

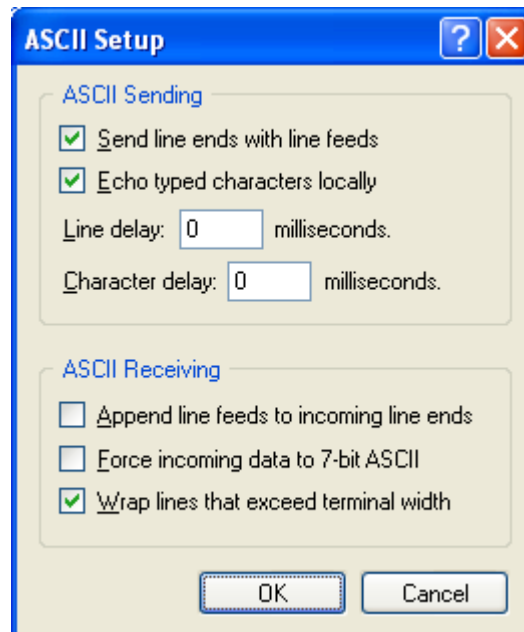

6. Check “**Send line ends with line feeds**” and “**Echo typed characters locally**” and click “**OK**”.





7. Key in commands such **RW**, **MZ**, and **RG** in the main screen to test...

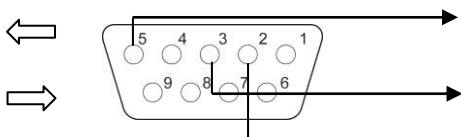



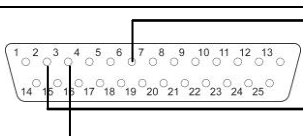





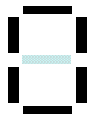
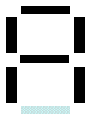

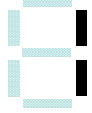

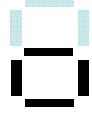
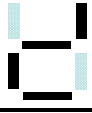
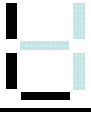

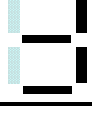

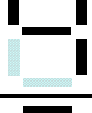





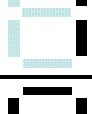
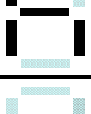

Appendix 1 RS-232 Wiring instruction

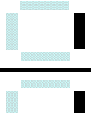
To connect RS232, please open the housing, RS232's PIN connectors locate on the bottom-right corner of the mainboard. The most common connection method is using 9PIN and 25PIN, as shown below:

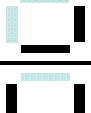
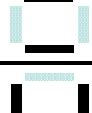
PC	PIN	Function	Female 9 PINS	CN12	Function	GTW
	2	Transmit Data		5	SG	
	3	Receive Data		1	RxD	
	5	Signal Ground		2	TxD	

Printer	PIN	Function	Male 25 PINS	CN12	Function	GTW
	2	Receive Data		5	SG	
	3	Transmit Data		1	RxD	
	7	Signal Ground		3	TxD	

Appendix 2 7-Segment Display Characters

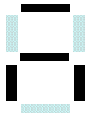
Number	Display	Letter	Display	Letter	Display
0		A		N	
1		B		O	
2		C		P	
3		D		Q	
4		E		R	
5		F		S	
6		G		T	
7		H		U	
8		I		V	
9		J		W	
		K		X	
		L		Y	
°C		M		Z	