



## PID TEMPERATURE CONTROL UNITS ESM-XX20



ESM-9920, ESM-9420, ESM-7720, ESM-4920, ESM-4420

**PID Temperature Control Units**

- 4 digit process (PV) and 4 digit set (SV) display
- Process input (TC, RTD)
- Programmable ON/OFF, P, PI, PD and PID control forms
- Adaptation of PID Coefficients to the system with Self-Tune and AUTO-Tune operations
- Programmable Heating or Cooling Functions for Control Output
- Selectable Alarm Functions for Alarm Output

ESM series temperature controllers are designed for measuring and controlling a process value. They can be used in many applications with their TC and RTD temperature measurement input, multi-function control outputs, selectable alarm functions. They are mainly used in glass, plastic, petro-chemistry, textile, automotive and machine production industries. Accurate and advanced controlling is performed with selectable ON-OFF, P, PI, PD, PID and Self Tune and Auto Tune PID functions.

### SPECIFICATIONS

**Process Input :** TC, RTD

Thermocouple (TC): J, K, R, S and T (IEC584.1)(ITS90)

Thermoresistance (RTD): PT-100 (IEC751)(ITS90)

**Measurement Range :** Please refer to Table-1 for selection of input type and scale.

**Accuracy :** ± 0.25% of scale for thermocouple and thermoresistance

**Cold Junction Compensation :** Automatically ±0.1°C/1°C

**Line Compensation :** Maximum 10 Ohm

**Sensor Break Protection :** Upscale

**Sampling Cycle :** 3 samples per second

**Input Filter :** 1.0 second

**Control Form :** ON/OFF, P, PI, PD or PID (Control form can be programmed by the user)

### OUTPUT

**Process Output :** Relay (5A@250V~ at resistive load) or SSR Driver Output (Maximum 24mA, Max. 12V=)

**Alarm Output :** Relay(5A@250V~ at resistive load) or SSR Driver Output(Alarm Output - 2) (Maximum 24mA, Max. 12V=)

### SUPPLY VOLTAGE

24V ~ (±15%) 50/60Hz - 3VA or 24V = (±15%) - 3W

230V ~ (±15%) 50/60 Hz - 3VA

115V ~ (±15%) 50/60 Hz - 3VA

24V ~ (±15%) 50/60 Hz - 3VA

(It must be determined in order)

### DISPLAY

**Process Display :**

ESM-4420 : 10.1 mm Red 4 digit LED Display

ESM-4920 : 13.2 mm Red 4 digit LED Display

ESM-7720 : 13.2 mm Red 4 digit LED Display

ESM-9420 : 10.1 mm Red 4 digit LED Display

ESM-9920 : 19 mm Red 4 digit LED Display

**Set Value Display :**

ESM-4420 : 8 mm Green 4 digits LED Display

ESM-4920 : 8 mm Green 4 digits LED Display

ESM-7720 : 9.1 mm Green 4 digits LED Display

ESM-9420 : 8 mm Green 4 digits LED Display

ESM 9920 : 10.8 mm Green 4 digits LED Display

**Leds :** PS (Process Set Value), PO (Process Output Status Led),

AS1, AS2 (Alarm Set Values), AO1, AO2 (Alarm Output Status

### ENVIRONMENTAL RATINGS and PHYSICAL SPECIFICATIONS

**Operating Temperature :** 0...50°C

**Humidity :** 0-90%RH (none condensing)

**Protection Class :** IP65 at front, IP20 at rear

**Weight :** ESM-4420 : 220 gr. , ESM-4920 : 240 gr.

ESM-7720 : 270 gr. , ESM-9420 : 230 gr.

ESM-9920 : 340 gr.

**Dimension :**

ESM-4420 : (48 x 48mm, Depth: 95mm)

ESM-4920 : (96 x 48mm, Depth: 94.5mm)

ESM-7720 : (72 x 72mm, Depth: 95.5mm)

ESM-9420 : (48 x 96mm, Depth: 94.5mm)

ESM-9920 : (96 x 96mm, Depth: 96mm)

**Panel CutOut :**

ESM-4420 : (46 x 46mm)

ESM-4920 : (92 x 46mm)

ESM-7720 : (69 x 69mm)

ESM-9420 : (46 x 92mm)

ESM-9920 : (92 x 92mm)

### Electrical Wirings

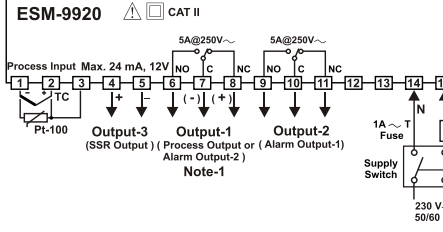
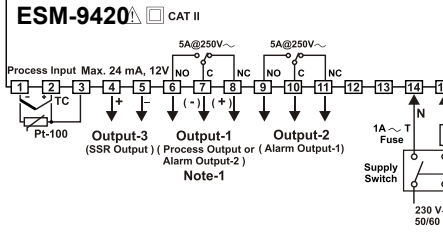
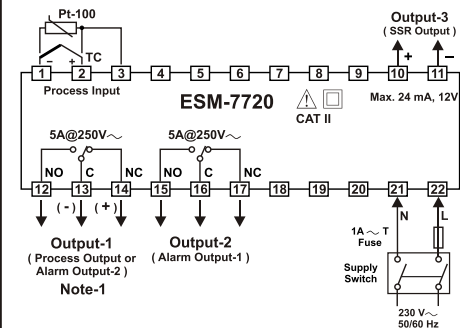
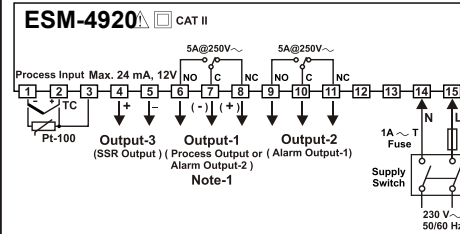
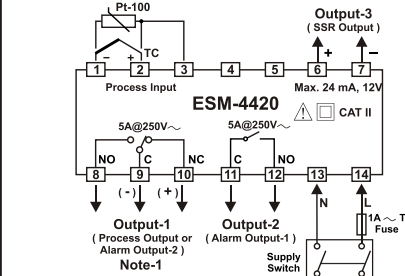

**Note-1:** If process output is SSR driver output, pay attention to the

### DIMENSIONS

ESM-4420

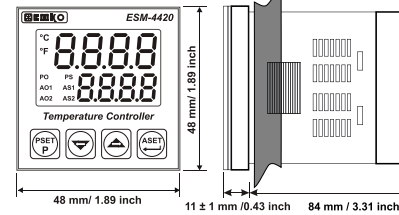

ESM-4920

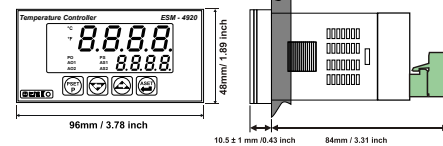

ESM-7720

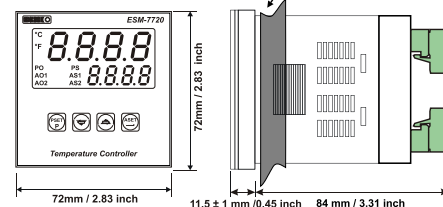

ESM-9420

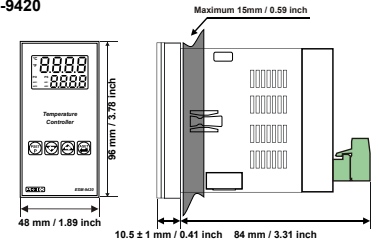

ESM-9920

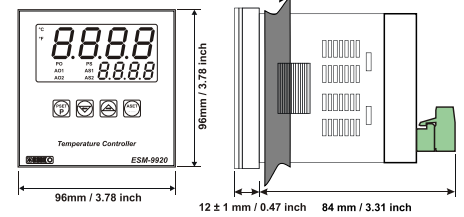

### PANEL MOUNTING

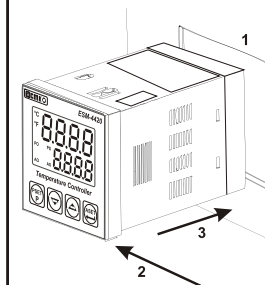

1-Before mounting the device in your panel, make sure that the cutout is of the right size.

2-Check front panel gasket position

3-Insert the device through the cutout. If the mounting clamps are on the unit, put out them before inserting the unit

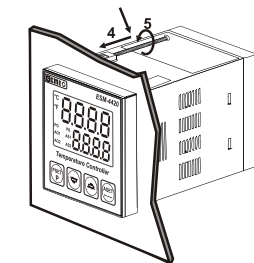

4-Insert the unit in the panel cut-out from the front side.

5- Insert the mounting clamps to the holes that located top and bottom sides of device and screw up the fixing screws until the unit completely immobile within the panel.

### Access and Change Set Values

#### Main Screen

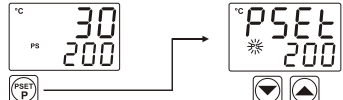

Press PSET Button.

Press increment or decrement button to change Process Set value.

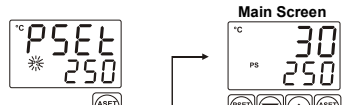

Press ASET/OK Button to save new Process set value and return the main screen.

Press ASET/OK Button.

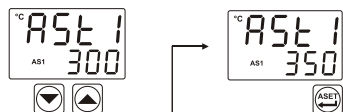

Press increment or decrement button to change Alarm1 Set value.

Press ASET/OK Button to save new Alarm set value and return the main screen.

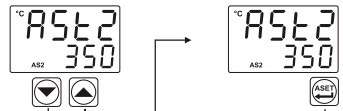

Press increment or decrement button to change Alarm2 Set value.

Press ASET/OK Button to save new Alarm set value and return the main screen.

#### Main Screen

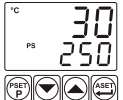

Note: User can exit from Set Value section without saving the values by pressing  $\leftarrow$  button.  
If no operation for 120 seconds, device automatically exits from Set Value section.

### Easy Access Diagram For Program Parameters

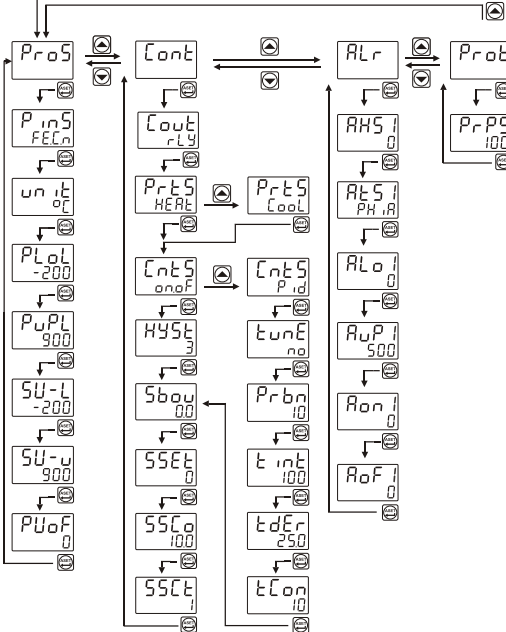
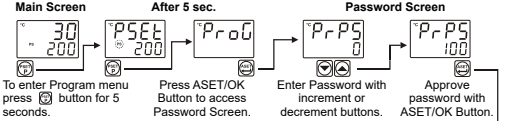

Note: If user does not do anything for 120 seconds while device is on programming section, device turns to operation screen.

### Easy Access Diagram For Sensor Break Output Value

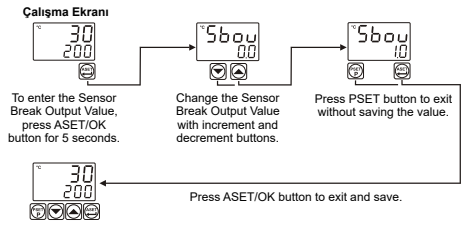

Note: If user does not do anything for 120 seconds while device is on this section, device turns to operation screen.

Note-2: Sensor Break Output Value can be adjusted on programming section too.

### Tune Operation

**Starting the Tune operation**  
 1-Enter to the programming section  
 2-Select SELF or Auto, tunE parameter in Cont menu. Press ASET/OK button for saving the parameter and turn to the main operation screen.  
 3-Observe that "tunE" blinks in set display.  
**Note:** For starting the Self Tune operation.  
**Heating Tune Operation:** Process value must be lower than process set value at least 5% of full scale.  
**Cooling Tune Operation:** Process value must be greater than process set value at least 5% of the full scale. If this condition is not okay, tErr blinks on the screen for 10 seconds.

**Cancelling Tune operation :**  
 1-If sensor breaks;  
 2-If Tune operation can not be completed in 8 hours;  
 3-While heating Tune is running, if process value becomes greater than Process Set value;  
 4-While cooling Tune is running, if process value becomes less than Process Set value;  
 5-While Tune operation is running, if user changes the process set value;  
 Then Tune operation is canceled, device continues to run with former PID parameters without changing PID parameters.

#### Pro5 : Process Menu Parameters

P in5 : Process input type selection ; (Default: FECL)  
 FECL : I type (Fe,Cu,Ni) Thermocouple , -200°C,900°C ; -328°F,1652°F  
 nCrn : I type (Ni,Cr,Ni) Thermocouple , -200°C,1300°C ; -328°F,2372°F  
 P i3r : R type (Pt13%RhPt) Thermocouple , 0°C,1700°C ; 32°F,3092°F  
 P i0r : S type (Pt10%RhPt) Thermocouple , 0°C,1700°C ; 32°F,3092°F  
 tunE : T type (Cu,Cu,Ni) Thermocouple , -200°C,400°C ; -328°F,752°F  
 rtd0 : Pt -100 , -200°C,650°C ; -328°F,1202°F  
 rtd1 : Pt -100 , -199.9°C,650.0°C ; -199.9°F,999.9°F  
 Un tE : Unit Selection, °C or °F can be chosen. (Default: °C)  
 PLoL : Operation Scale minimum (Low Limit) value. It changes according to the process input type and scale. (Default: -200)  
 P uPL : Operation Scale maximum (High Limit) value. It changes according to the process input type and scale. (Default: 900)  
 SU-L : Process Set Value Low Limit. Minimum set value is defined with this parameter. It changes according to the process input type and scale. (Default: -200)  
 SU-u : Process Set Value High Limit. Maximum set value is defined with this parameter. It changes according to the process input type and scale. (Default: 900)  
 P uoF : Display offset for process value. It can be adjusted from -10% of scale to 10% of scale. It is added to the process display value. (Default: 0)  
**Note:** If process input type selection (P in5) is changed, PLoL, P uPL, SU-L, SU-u, P uoF, RLS, R uP, R oF, R oF, PSET, AS1 and AS2 parameters may need to be updated according to the input type selection.

#### Cont : Control Menu Parameters

CoL : This parameter determines, which output will be Process control output. If rLY is chosen, process output is relay output, if 55r is chosen, process output is SSR output. (Default: 55r)  
 Prt5 : Process Type Selection. It can be HErE or CoL. (Default: HErE)  
 Cnt5 : Process Control Type Selection. It can be onof or P id. (Default: onof)  
 tunE : If tune parameter is set to SELF, device start to Self Tune to calculate PID parameters automatically. If tune parameter is set to Auto, device start to Auto Tune to calculate PID parameters automatically. This parameter is shown if Cnt5 = P id. (Default: no)  
 Prbn : Proportional band. It can be adjusted from %1 to %100. If Cnt5 = P id, then this parameter can be observed. (Default: 10.0)  
 tntE : Integral Time. It can be adjusted from 0 to 3600 second. If Cnt5 = P id, then this parameter can be observed. (Default: 100)  
 tdeR : Derivative Time. It can be adjusted from 0.0 to 999.9 second. If Cnt5 = P id, then this parameter can be observed. (Default: 25.0)  
 EoN : Output Control Period. It can be adjusted from 1 to 150 second. If Cnt5 = P id, then this parameter can be observed. (Default: 10)  
 HYSL : Hysteresis value. It can be adjusted from %0 to %50 of the Scale (P uPL-PLoL). If Cnt5 = onof, then this parameter can be observed. (Default: 3)  
 Sbow : Sensor Break Output Value. It can be adjusted from %0 to %100. (Default: 0.0)  
 SSEL : Soft Start Set value. Device operates in Soft Start mode, until the temperature reaches Soft Start set value. (Default: no)  
 SScO : Soft Start Control Output. This parameter determines soft start mode control output percentage. (Default: 10.0)  
 SScL : Soft Start Control Time. This parameter determines soft start mode control time. (Default: 1)

### RLR : Alarm Menu Parameters

RHS 1 : Alarm Hysteresis value. It can be adjusted from %0 to %50 of the Scale (R uPL - RLoL). (Default: 0)  
 RLS 1 : Alarm Type Selection. (Default: PH ,R)  
 RLo 1 : Alarm Set Low Limit parameter. It can be adjusted from Operation Scale minimum to Alarm Set High Limit. (Default: 0)  
 R uP 1 : Alarm Set High Limit parameter. It can be adjusted from Alarm Set Low Limit to Operation Scale minimum. (Default: 500)  
 RoN1 : Alarm on Delay Time. It can be adjusted from 0 to 9999 seconds. (Default: 0)  
 RoF1 : Alarm off Delay Time. It can be adjusted from 0 to 9998 seconds. If it is higher than 9998, LtCH is seen on the screen and Alarm Latching Output is selected. (Default: 0)  
 RHS2 : Alarm Hysteresis value. It can be adjusted from %0 to %50 of the Scale (R uPL - RLoL). (Default: 0)  
 RLS2 : Alarm type selection. (Default: PH ,R)  
 RLo2 : Alarm Set Low Limit parameter. It can be adjusted from Operation Scale minimum to Alarm Set High Limit. (Default: 0)  
 R uP2 : Alarm Set High Limit parameter. It can be adjusted from Alarm Set Low Limit to Operation Scale maximum. (Default: 500)  
 RoN2 : Alarm on Delay Time. It can be adjusted from 0 to 9999 seconds. (Default: 0)  
 RoF2 : Alarm off Delay Time. It can be adjusted from 0 to 9998 seconds. If it is higher than 9998, LtCH is seen on the screen and Alarm Latching Output is selected. (Default: 0)  
**Note:** Alarm-2 parameters (RHS2, RLS2, RLo2, R uP2, RoN2, RoF2) are active, if CoL parameter is set as 55r.

### PrPt : Protection Menu Parameter

PrPt : Password for accessing to the programming section. It can be adjusted from 0 to 9999.  
 If PrPt is 0, password screen is not observed. If PrPt is different from 0 and user enters to the menu pages without entering the password, all the menus can be observed except protection menu PrPt. But device does not allow to do any

### Alarm Types

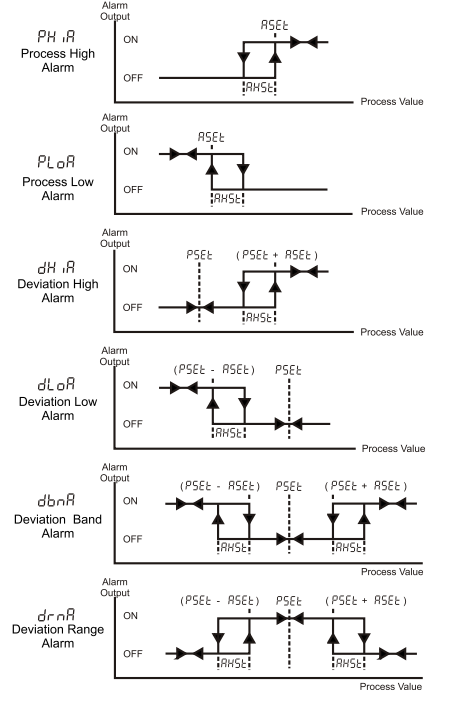

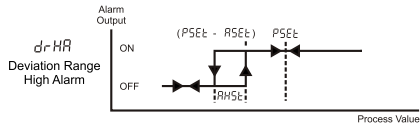

### Error Messages



1- Sensor failure in analog inputs. Sensor connection is wrong or there is no sensor connection.



2- If value that is read from the analog input is lower than process set low limit parameter  $P_{LoL}$ , value on the top display starts to blink like on the picture.



3- If value that is read from the analog input is higher than process set high limit parameter value  $P_{uP_{HL}}$ , value on the top display starts to blink like on the picture.

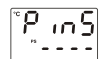

4- If programming section entering password is different from "0" and user accesses to the parameter by ASET/OK button without entering the password and wants to change a parameter, the warning message is shown on the bottom display as shown on the left. Device does not allow to do any changes without entering the password correctly.

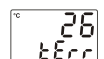

5- In programming section, when Tune operation is selected, if warning which is shown on the left blinks in operation screen for 10 seconds, it means that start conditions is not okay for Tune operation.



### Installation



Before beginning installation of this product, please read the instruction manual and warnings below

- In package ,
- One piece unit
  - Two pieces mounting clamp
  - One piece instruction manual

A visual inspection of this product for possible damage occurred during shipment is recommended before installation. It is your responsibility to ensure that qualified mechanical and electrical technicians install this product.

If there is danger of serious accident resulting from a failure or defect in this unit, power off the system and the electrical connection of the device from the system.

The unit is normally supplied without a power switch or a fuse. Use power switch and fuse as required.

Be sure to use the rated power supply voltage to protect the unit against damage and to prevent failure.

Keep the power off until all of the wiring is completed so that electric shock and trouble with the unit can be prevented.

Never attempt to disassemble, modify or repair this unit. Tampering with the unit may results in malfunction, electric shock or fire.

Do not use the unit in combustible or explosive gaseous atmospheres. During the equipment is putted in hole on the metal panel while mechanical installation some metal burrs can cause injury on hands, you must be careful.

Montage of the product on a system must be done with it's mounting clamp. Do not do the montage of the device with inappropriate mounting clamp. Be sure that device will not fall while doing the montage.

It is your responsibility if this equipment is used in a manner not specified in this instruction manual.

### Warranty

EMKO Elektronik warrants that the equipment delivered is free from defects in material and workmanship. This warranty is provided for a period of two years. The warranty period starts from the delivery date.

This warranty is in force if duty and responsibilities which are determined in warranty document and instruction manual performs

### Maintenance

Repairs should only be performed by trained and specialized personnel. Cut power to the device before accessing internal parts. Do not clean the case with hydrocarbon-based solvents (Petrol, Trichlorethylene etc.). Use of these solvents can reduce the mechanical reliability of the device. Use a cloth dampened in ethyl alcohol or water to clean the external plastic case.

### Other Informations

#### Manufacturer Information:

Emko Elektronik Sanayi ve Ticaret A.Ş.  
Demirtaş Organize Sanayi Bölgesi Karanfil Sk. No:6 16369  
BURSA/TURKEY  
Phone : +90 224 261 1900  
Fax : +90 224 261 1912

#### Repair and Maintenance Service Information:

Emko Elektronik Sanayi ve Ticaret A.Ş.  
Demirtaş Organize Sanayi Bölgesi Karanfil Sk. No:6 16369  
BURSA/TURKEY  
Phone : +90 224 261 1900  
Fax : +90 224 261 1912

### Ordering Information

ESM-4420 (48x48 DIN 1/16)	A	B	C	D	E	/	F	G	H	I	/	U	V	W	Z
ESM-4920 (96x48 DIN 1/8)															
ESM-7720 (72x72 DIN Size)															
ESM-9420 (48x96 DIN 1/8)															
ESM-9920 (96x96 DIN 1/4)															

#### A Supply Voltage

- 24V ~ 50/60Hz or 24V --- ( ± %15 )
- 24V ~ ( ± %15 ) 50/60Hz
- 115V ~ ( ± %15 ) 50/60Hz
- 230V ~ ( ± %15 ) 50/60Hz
- Customer

#### BC Input Type

- Configurable (Table-1)

#### D Serial Communication

- None

#### E Output-1(Process or Alarm)

- Relay Output (5A@250V~, Resistive Load)
- SSR Driver Output (Max. 24mA, Max.12V --- )

#### FG Output-2(Alarm)

- Relay Output (5A@250V~, Resistive Load)

#### HI Output-3(Process)

- SSR Driver Output (Max. 24mA, Max.12V --- )

#### Table-1

BC Input Type(TC)	Scale(°C)	Scale(°F)
23 J, Fe CuNi IEC584.1(ITS90)	-200°C, 1300°C	-328°F, 2372°F
25 K, NiCr Ni IEC584.1(ITS90)	0°C, 1700°C	32°F, 3092°F
27 R, Pt13%Rh Pt IEC584.1(ITS90)	0°C, 1700°C	32°F, 3092°F
28 S, Pt10%Rh Pt IEC584.1(ITS90)	0°C, 1700°C	32°F, 3092°F
29 T, Cu CuNi IEC584.1(ITS90)	-200°C, 400°C	-328°F, 752°F

#### BC Input Type(RTD)

BC Input Type(RTD)	Scale(°C)	Scale(°F)
39 PT 100, IEC751(ITS90)	-200°C, 650°C	-328°F, 1202°F
40 PT 100, IEC751(ITS90)	-199.9°C, 650.0°C	-199.9°F, 999.9°F



Thank you very much for your preference to use Emko Elektronik products, please visit our Your Technology Partner web page to download detailed user manual.

[www.emkoelektronik.com.tr](http://www.emkoelektronik.com.tr)