



RC-1219-C

SkyAir

Single-Split Non Inverter Series



www.daikin.com.my

DAIKIN MALAYSIA SALES & SERVICE SDN. BHD.

Head Office: Tel: 03-7953 8388 Fax: 03-7956 4371
Email: sales_enquiry@daikin.com.my, customer_service@daikin.com.my

- Branches:
- | | | | |
|-------------------|------------------|------------|------------------|
| • Kedah | Tel: 04-730 5670 | • Johor | Tel: 07-557 7788 |
| • Penang | Tel: 04-331 1670 | • Pahang | Tel: 09-567 6778 |
| • Perak | Tel: 05-548 2307 | • Kelantan | Tel: 09-747 4578 |
| • Negeri Sembilan | Tel: 06-768 8969 | • Sabah | Tel: 088-722 194 |
| • Melaka | Tel: 06-288 1133 | • Sarawak | Tel: 082-333 299 |

Authorized dealer:

Catalogue No. PLXDSMY1856



R32

R32

The Superior Refrigerant

This game changing refrigerant strikes the perfect balance between energy efficiency, ease of use and environmental sustainability, offering distinct advantages across the board. Bringing you comfort and a peace of mind.

Less Impact On Global Warming

The earth retains solar heat in the daytime for warming and then releases this heat at night, allowing it to maintain an optimal temperature range. However, with greenhouse gases increasing, it is more difficult to discharge heat and the planet is gradually becoming warmer. This is called global warming. R32 has only around 30% of the global warming potential of R410A and R22.

	Ozone Depletion Potential	Global Warming Potential
R32	0	675
R410A	0	2,090
R22	0.05	1,810

R32 has zero Ozone Depletion Potential (ODP), and lower Global Warming Potential (GWP) which contributes to the prevention of global warming.

Lesser Refrigerant Charge

Potential refrigerating effect of R32 is 1.5 times that of R22 or R410A. More specifically, pressure losses are lower with R32 than R22 or R410A for the same capacity and the liquid density of R32 is also 10% lower. As a result, the charging volume for R32 is approximately 30% less than that of R410A and R22.

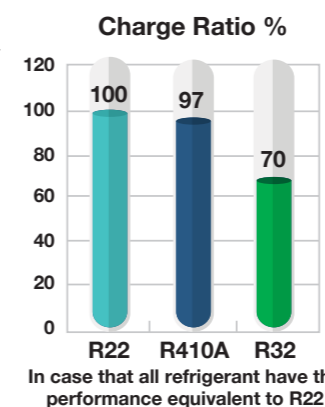

Easy Maintenance and Serviceability

Unlike R410A and R407C, which are mixed refrigerants, R32 is a Single component refrigerant. This means that no composition change occurs, and likewise R22, allows for easy liquid charge and gas charge.

	Composition (Mixture ratio wt%)
R32	Single Component
R410A	R32/R125 (50/50 WT%)
R22	Single Component

Series

50

60

85

100

125

140

160

Ceiling Cassette
8-Way Flow Type



Indoor unit

FCC50AV1M

FCC60AV1M

FCC85AV1M

FCC100AV1M

FCC125AV1M

FCC140AV1M

Ceiling Concealed
Middle Static
Pressure Type

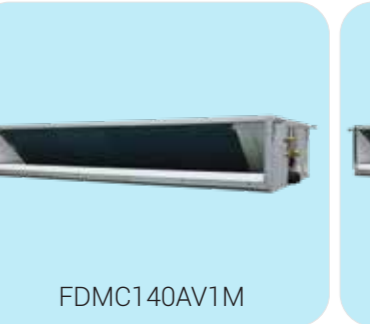

Indoor unit

FDMC50AV1M

FDMC60AV1M

FDMC85AV1M

FDMC100AV1M

FDMC125AV1M

FDMC140AV1M

FDMC160AV1M

Ceiling Exposed
Type

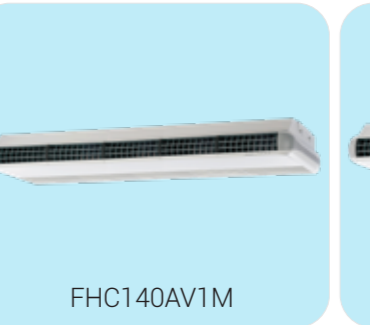

Indoor unit

FHC50AV1M

FHC60AV1M

FHC85AV1M

FHC100AV1M

FHC125AV1M

FHC140AV1M

FHC160AV1M

Outdoor Unit

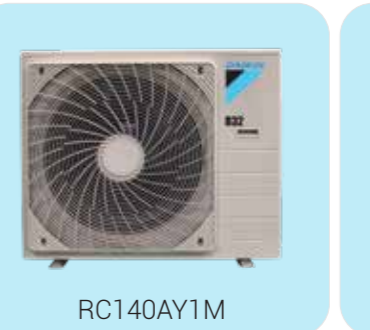

RC50AV1M

RC60AV1M

RC85AV1M

RC100AV1M

RC125AY1M

RC140AY1M

RC160AY1M

Power Supply

Indoor
220-240V / 1 phase / 50Hz

Indoor
200-240V / 1 phase / 50Hz

Indoor
220-240V / 1 phase / 50Hz

Outdoor
220-240V / 1 phase / 50Hz

Outdoor
380-415V / 3 phase / 50Hz

Outdoor
380-415V / 3 phase / 50Hz

Outdoor
380-415V / 3 phase / 50Hz

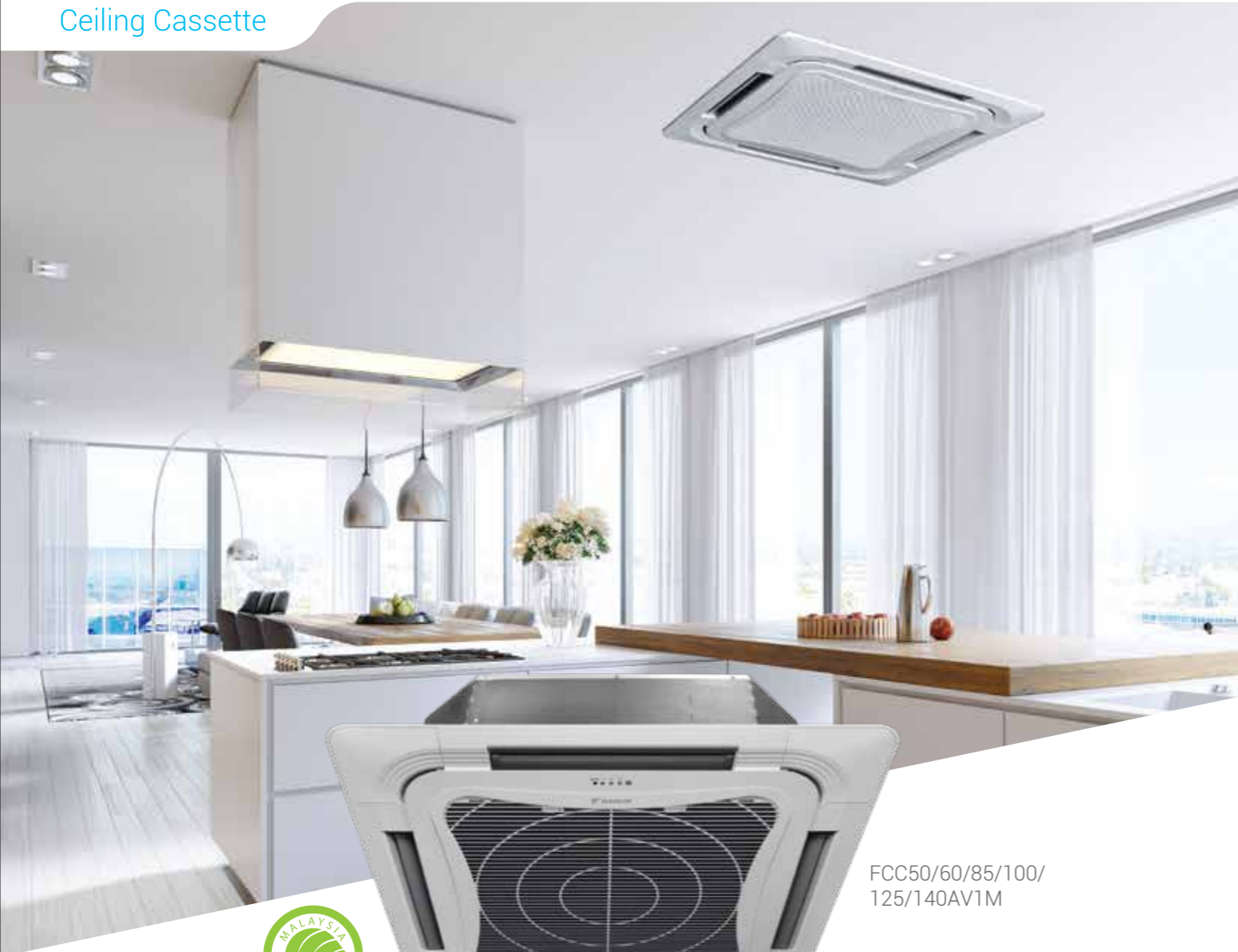

FCC50/60/85/100/
125/140AV1M



Cassette Air Conditioner with 8 Way Airflow
Provides Cooling Comfort to Every Corner



DGS01

Compact Wireless Remote Controller

- Supplied together with panel for user convenience.
- Prominent temperature display.
- Real-time clock display.
- Easily accessible buttons.



DSL8

Slim Wired Remote Controller (Optional)

- Dedicated button for Quiet and Turbo functions.
- Key lock function.
- Real-time timer. (7 days option, 2 events daily).
- Comes with 10m wired cable



BRC51D61

SHIRO Wired Remote Controller (Optional)

- Better external outlook with glossy finishing.
- Display with backlight for better viewing.
- Room temperature indication.
- Comes with 10m wired cable

Product Features



High Performance

R32 refrigerant properties boost the capacity and COP of units for selected models to achieve full tonnage.

Series	Capacity (Btu/hr)	
	R410A	R32
50	18,500	18,500
60	23,000	24,000 ↑ (Full 2TR)
85	30,000	30,000
100	36,000	36,000
125	42,000	42,000
140	46,000	48,000 ↑ (Full 4TR)



Energy Saving

R32 refrigerant properties provide better heat transfer compared to R410A refrigerant. Therefore, the efficiency of R32 models is tremendously improved. COP for R32 models increases by an average of 12% compared to R410A models.

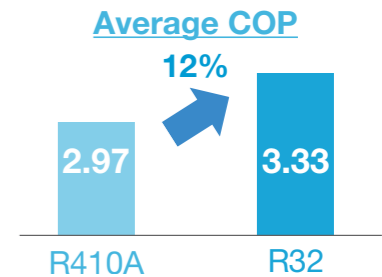

R32 models achieved higher efficiency!

COP(W/W)

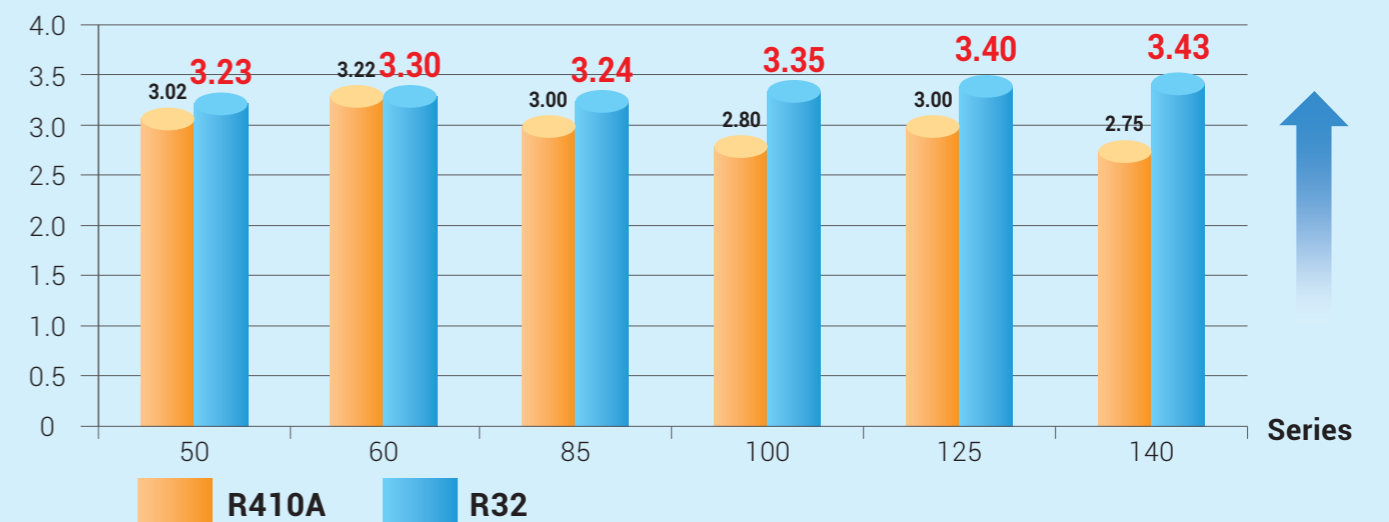

What is COP
(Coefficient of Performance)

COP is equal to capacity (kW) divided by power consumption (kW), and the larger the COP value, the higher the energy efficiency, enabling cooling and heating with less electricity and increasing the energy saving performance.

Better Indoor Air Quality



Advanced i-Plasma Technology

Highly effective in deactivating bacteria by damaging the microbial DNA and their surface structures by this advanced plasma technology.

It emits massive positive and negative ions, and sterilize surrounding air more effectively. FCC-A series emit 100 times more ion than ionizer technology in the current market by using our advance i-plasma technology.

Inspired by nature

Elegant Design Panel

Inspired by Nature. Combining with "butterfly" concept into modern ceiling cassette panel design to provide user a totally different outlook which match into current living lifestyle.



Cassette Panel



Intake Grille

Malaysia

 Daikin Ceiling Cassette has won Malaysia Good Design Award 2015 in recognition of product design excellence, innovation and creativity.

Comfort

Unified Square Panels

- Panel size is the same for all models.
- It is easy to maintain a neat appearance when multiple units are installed in the same room.

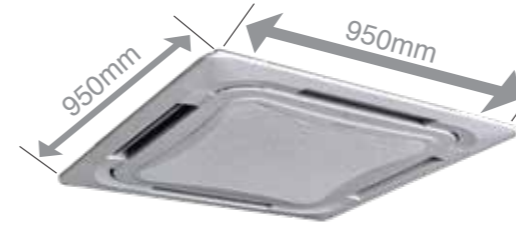

Same for all models

3 Different Swing Pattern

To increase the comfort level of the air conditioned area, the system is built-in with 3 different types of air flow pattern to suit different requirements.

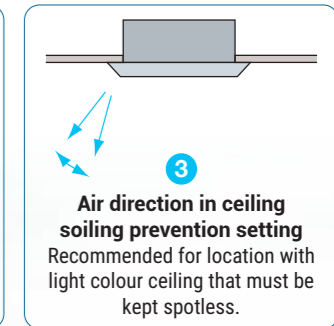
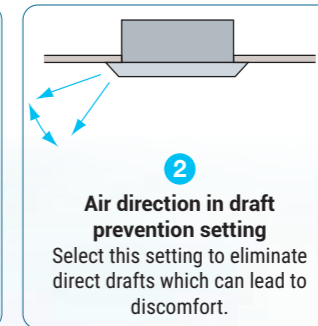
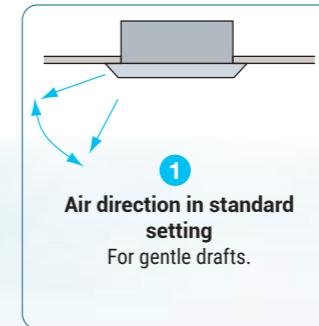

The default setting for air swing pattern is 1.
 The air swing pattern can be selected through both wireless and wired remote controller by holding down the Swing button for 4 seconds

8 – Way Air Flow Discharge

- The unit delivers even and comfortable air-conditioning to all areas, covering to every corner of the room by combining 8-ways air discharge.
- Air flow direction can be fixed at your designated angle by the remote controller with auto swing mode.

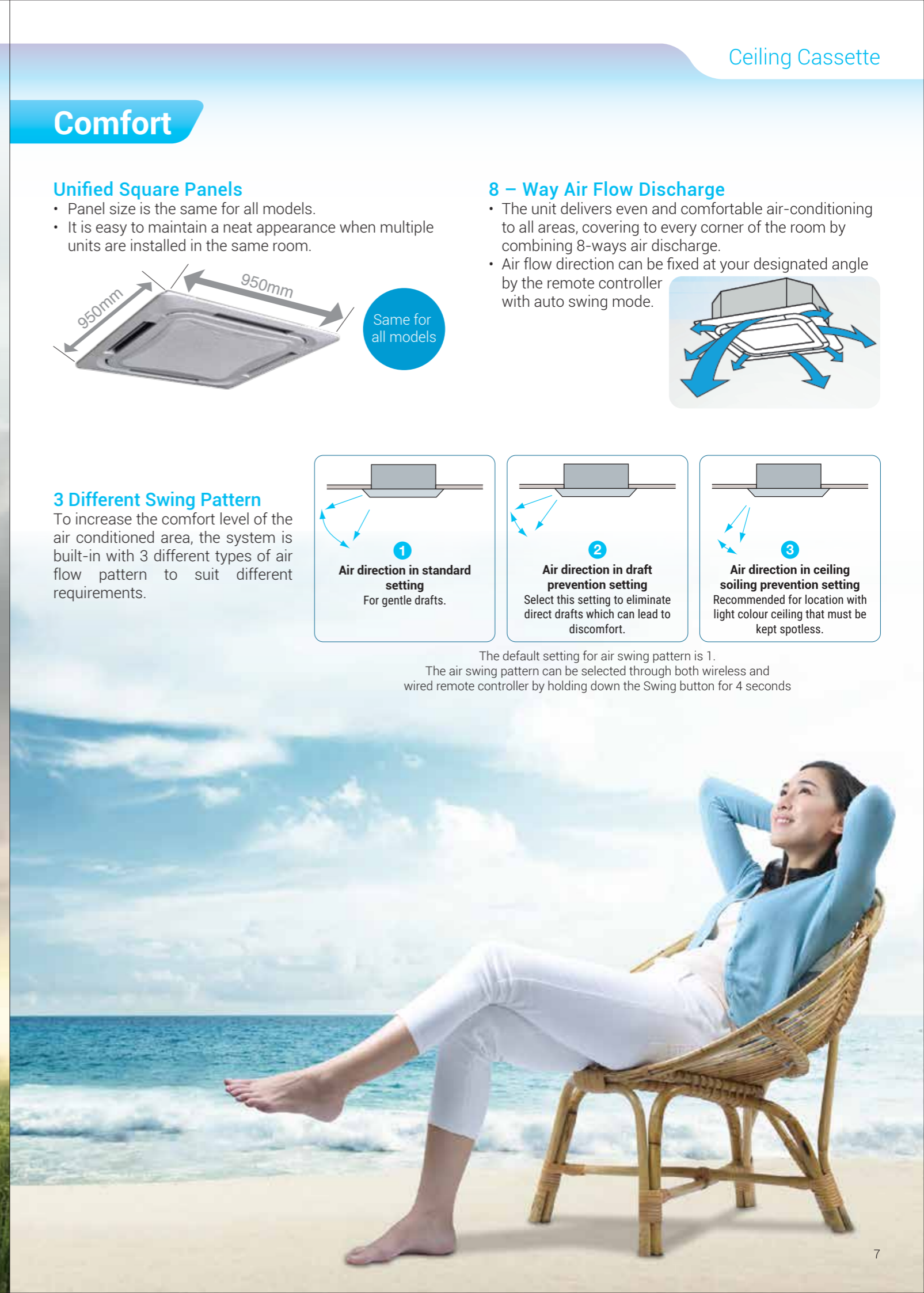
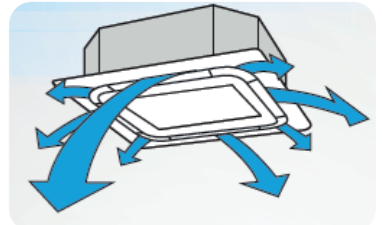

Easy Installation & Serviceability

Installable In Tight Ceiling Spaces

Unit height as low as 246mm.

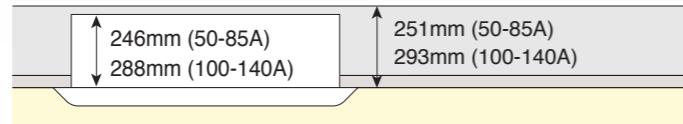

Easy Height Adjustment

Each corner of the unit has an adjuster pocket that allows you to easily adjust the unit's suspended height.

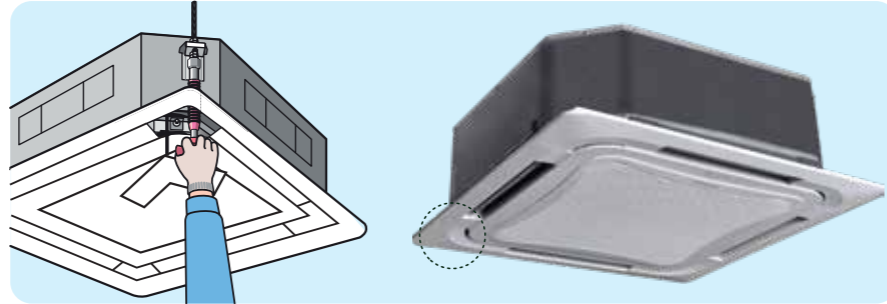

Easy Accessible To Control Box Location

- Instead on conventional hidden control box location, new cassette control box can be easily and safely accessed.
- Without adjusting the panel, control box can be directly accessed from the intake grille.
- Extra time saving on installation or servicing.

Drain Pump Is Equipped As Standard

- The unit comes with high head drain pump of 700mm.
* pressure head as standard
- Drainage Protection: Safety Float incorporated in drain pump. It's function is to monitor water level and trigger drain pump to cut in when drainage water reached certain level.
* 700mm calculated from drain pipe outlet to highest elevation point

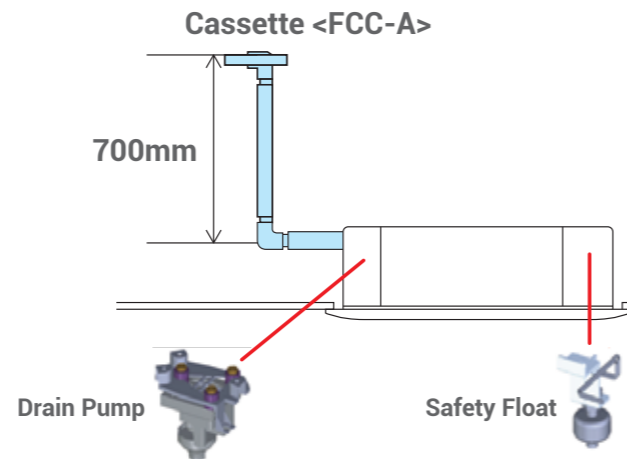

Cleanliness

Non-Flocking Flaps

- Flaps can be detached without use of tools.
- Dirt does not cling to non-flocking flaps.
- They are easy to clean.

Saranet Filter

- Functions as standard dust filtration with 55% efficiency.
- Supplied as standard with Cassette 3x3 panel.

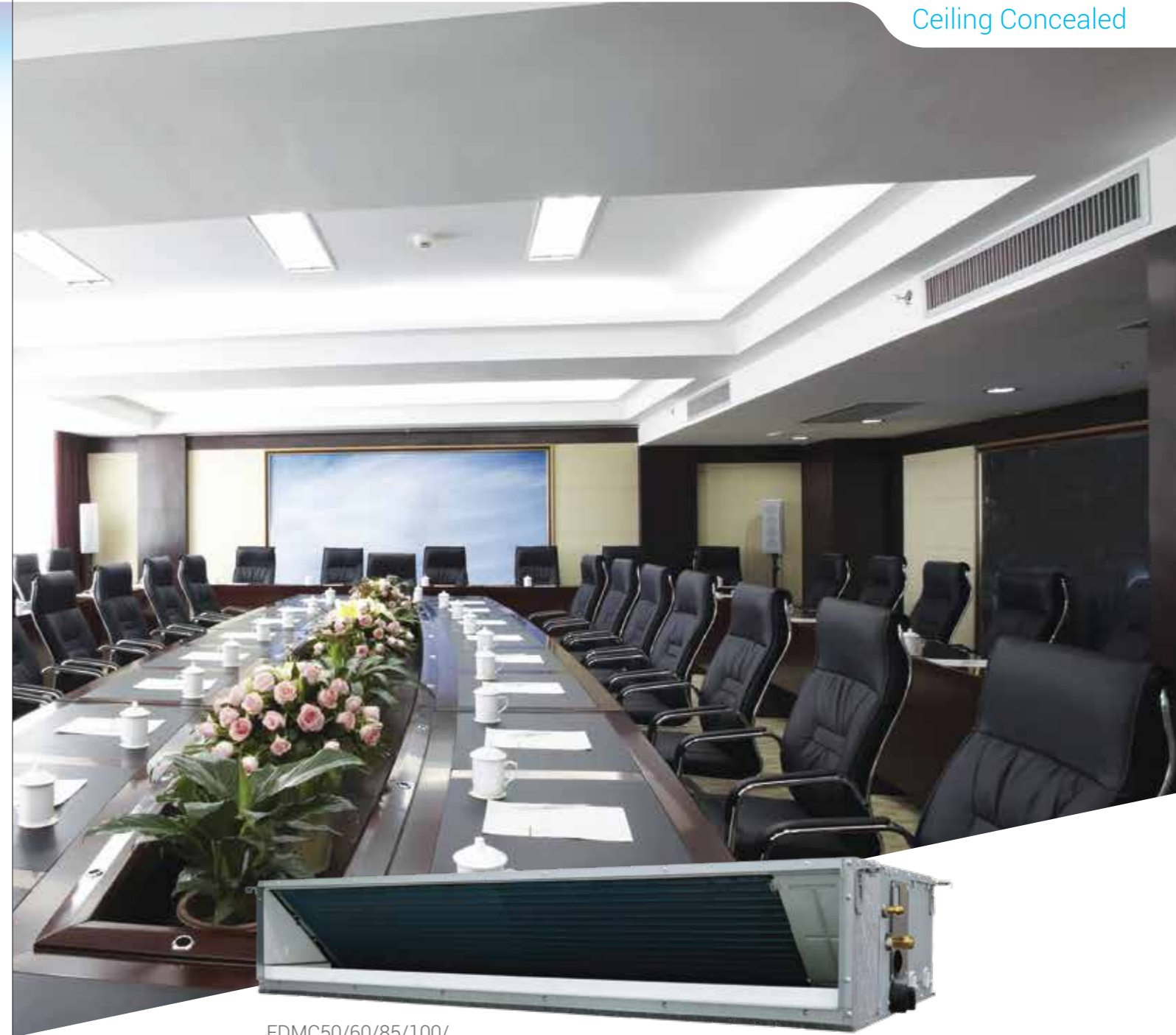

FDMC50/60/85/100/
125/140/160AV1M

Low Height and New Design
for Flexible Application



DSLM8

Slim Wired Remote Controller

- Dedicated button for Quiet and Turbo functions.
- Key lock function.
- Real-time timer. (7 days option, 2 events daily).
- Comes with 10m wired cable.



BRC51D62

SHIRO Wired Remote Controller (Optional)

- Better External Outlook with Glossy Finishing.
- Display with Backlight for better viewing.
- Room temperature indication.
- Comes with 10m wired cable.

Product Features



High Performance

R32 refrigerant properties boost the capacity and COP of units for selected models to achieve full tonnage.

Capacity (Btu/hr)		
Series	R410A	R32
50	18,000	18,500 ↑
60	21,000	23,500 ↑
85	30,000	30,000
100	36,000	36,000
125	42,000	42,000
140	47,000	48,000 ↑ (Full 4TR)
160	55,000	55,000



Energy Saving

R32 refrigerant properties provide better heat transfer compared to R410A refrigerant. Therefore, the efficiency of R32 models is tremendously improved. Average COP for R32 models increases by an average of 15% compared to R410A models.

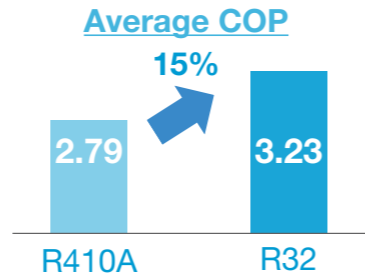

COP (W/W)

R32 models achieved higher efficiency!

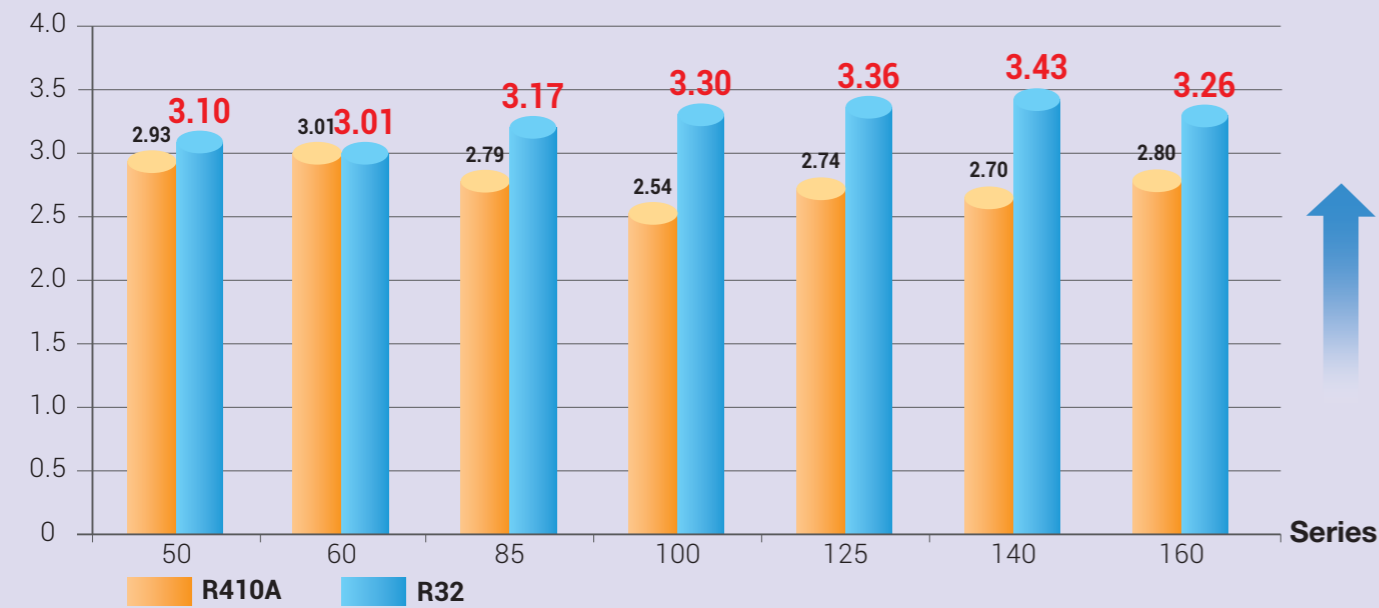

New Design

New Outlook and Operation

New Blow Through System results in low noise operation of unit.



Sound Pressure Level (dBA)

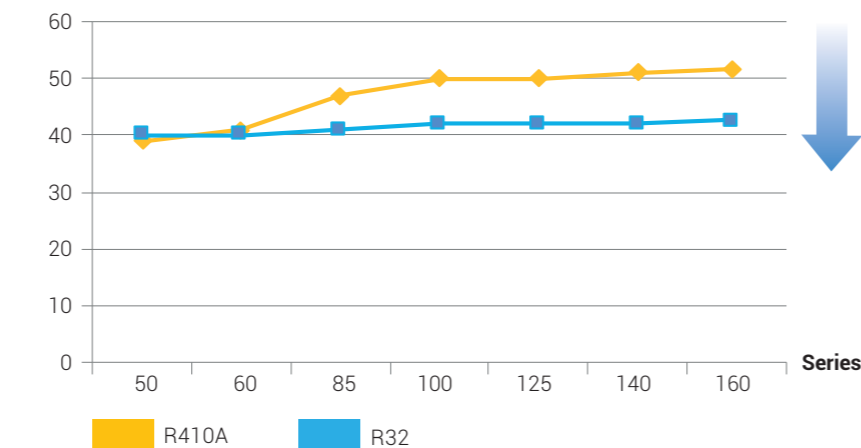

Design And Installation Flexibility

Extreme Low Height Of Units

Installation is possible even in buildings with narrow ceiling spaces.

Series	50/60	85	100/125/140/160
Height (mm)	250	250	250
Width (mm)	700	1,000	1,400
Depth (mm)	700	700	700



One of the industry's most compact bodies in the mid-static pressure range.

Convertible Return Air Configuration

Easy conversion from rear return to bottom return is possible to be done on new ceiling concealed to fit in according to building structures.

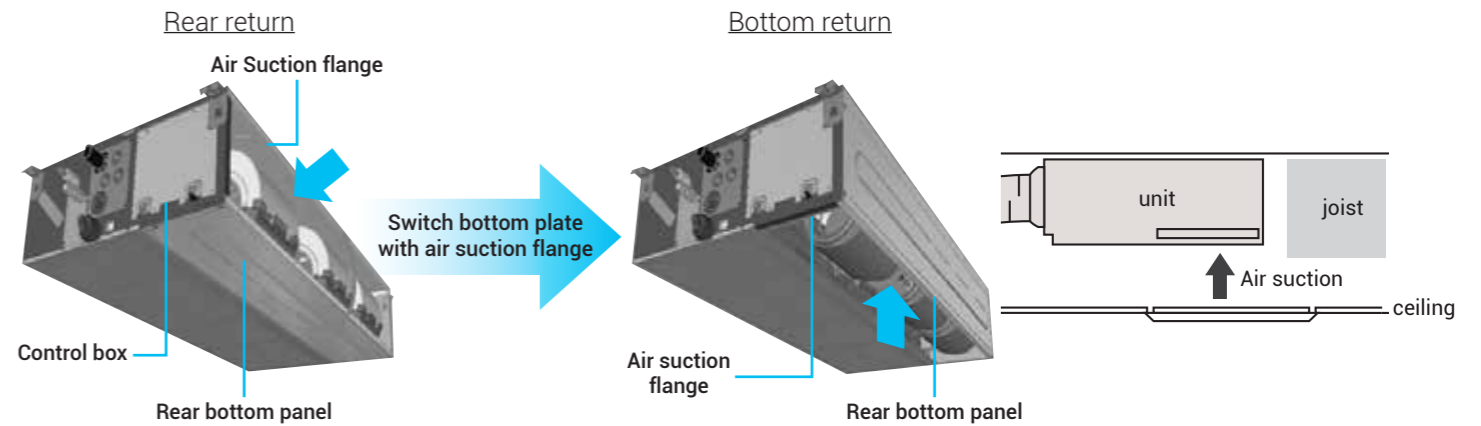

Comfort

Switchable Fan Speed: 3 Steps And Auto

- Control of fan speed up to 3-step.
- The unit has up to 3 different fan speed available for comfort selection.



Easy Selectable External Static Pressure (ESP)

- 2-different ESP can be easily selected by switching the connector inside the control box as shown below.
- According to duct design required for comfort, the adjustment can be done easily during installation at the control box.

Series	50	60	85	100	120	140	160
Preset ESP (Pa)	30	30	30	50	50	50	50
Changeable ESP (Pa)	50	50	50	80	80	80	60

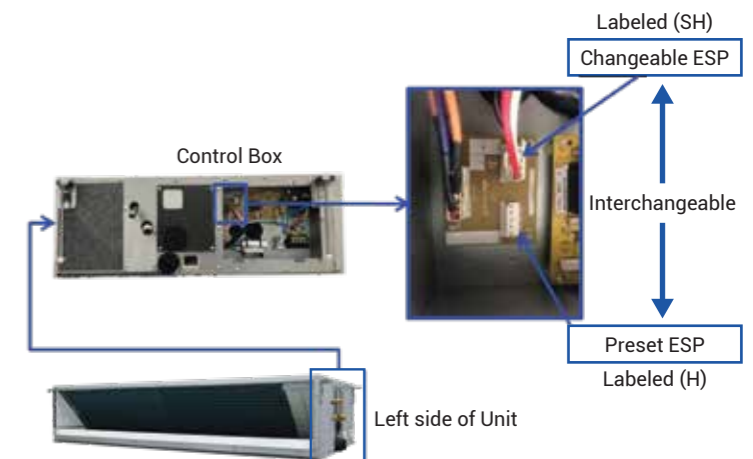

What is ESP (External Static Pressure)

External Static Pressure is the measurement of the total resistance in a duct system that the fan has to work against.

Easy Service Maintenance

Drain Pan Maintenance Check Window

Allow the checking of drainage or dirt in the drain pan without requiring any tools. Check window is located below the drain pump slot (for installation of optional drain pump).

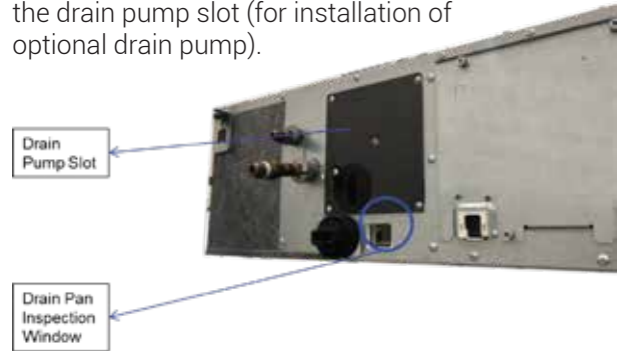

Easy Accessible To Blowers And Motors

- Blowers and Motors can be easily accessible by just removing rear bottom panel and mid flange as shown.
- Blowers can be removed from the housing easily as well by opening the housing case.

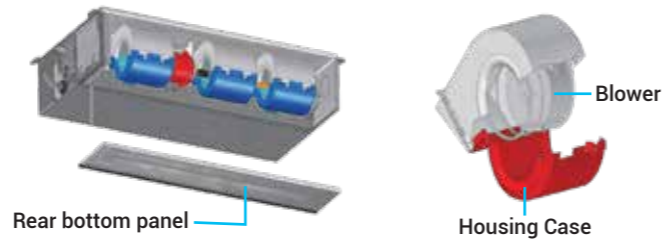

Easy Accessible to Drain Pan and Heat Exchanger

- Drain Pan and Coil can be easily accessible by removing front bottom panel and mid flange.
- Followed by steps as shown below, coil can be accessed once drain pan is removed.

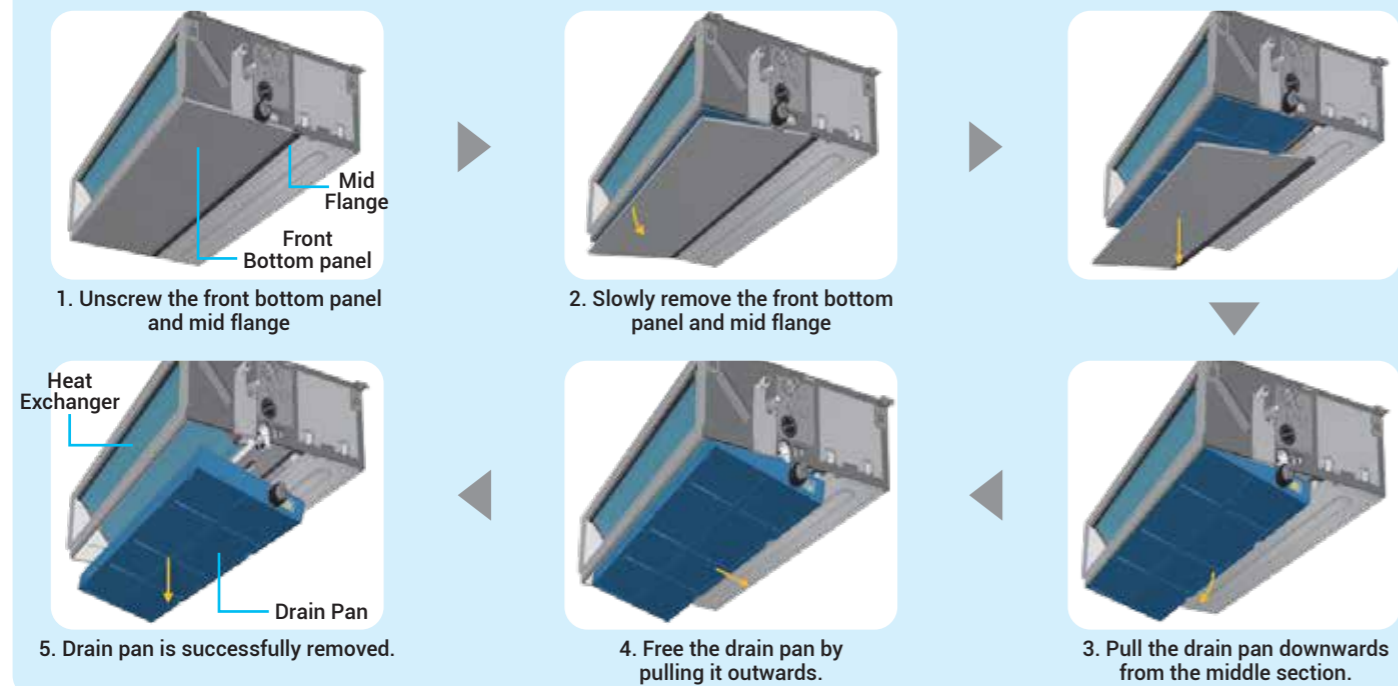

Option

Drain Pump Is Ready For Installation

- Drain pump is optional accessory for new ceiling concealed.
- If Drain Pump is required, it could be purchased as accessories and installed at the designated location of the unit.

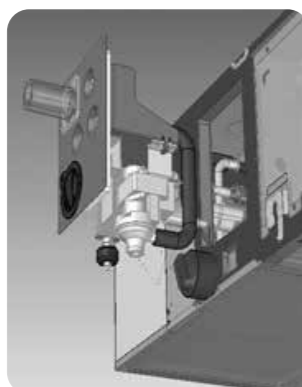

Part Number: BDU511A160V1

Saranet Filter

- Functions as dust filtration to trap dust in the air.



Part Number: 3P557870-1 (FDMC50/60A)
3P557868-1 (FDMC85A)
3P557863-1 (FDMC100/125/140/160A)



FHC50/60/85/100/125/140/160AV1M

Maximum air flow, providing cooling to far ends of the room



DGS01

Compact Wireless Remote Controller

- Supplied together with panel for user convenience.
- Prominent temperature display.
- Real-time clock display.
- Easily accessible buttons.



DSL8

Slim Wired Remote Controller (Optional)

- Dedicated button for Quiet and Turbo functions.
- Key lock function.
- Real-time timer. (7 days option, 2 events daily).
- Comes with 10m wired cable



BRC51D61

SHIRO Wired Remote Controller (Optional)

- Better external outlook with glossy finishing.
- Display with backlight for better viewing.
- Room temperature indication.
- Comes with 10m wired cable

Product Features



High Performance

R32 refrigerant properties boost the capacity and COP of units for selected models to achieve full tonnage.

Series	R410A	R32
50	18,000	18,500 ↑
60	21,000	23,500 ↑
85	29,000	29,500 ↑
100	35,000	36,000 ↑ (Full 3TR)
125	41,000	42,000 ↑
140	44,000	46,000 ↑
160	55,000	55,000



Energy Saving

R32 refrigerant properties provide better heat transfer compared to R410A refrigerant. Therefore, the efficiency of R32 models is tremendously improved. COP for R32 models increases by an average of 10% compared to R410A models.

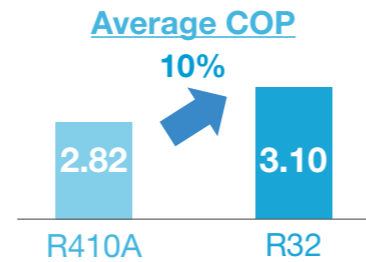

R32 models achieved higher efficiency!

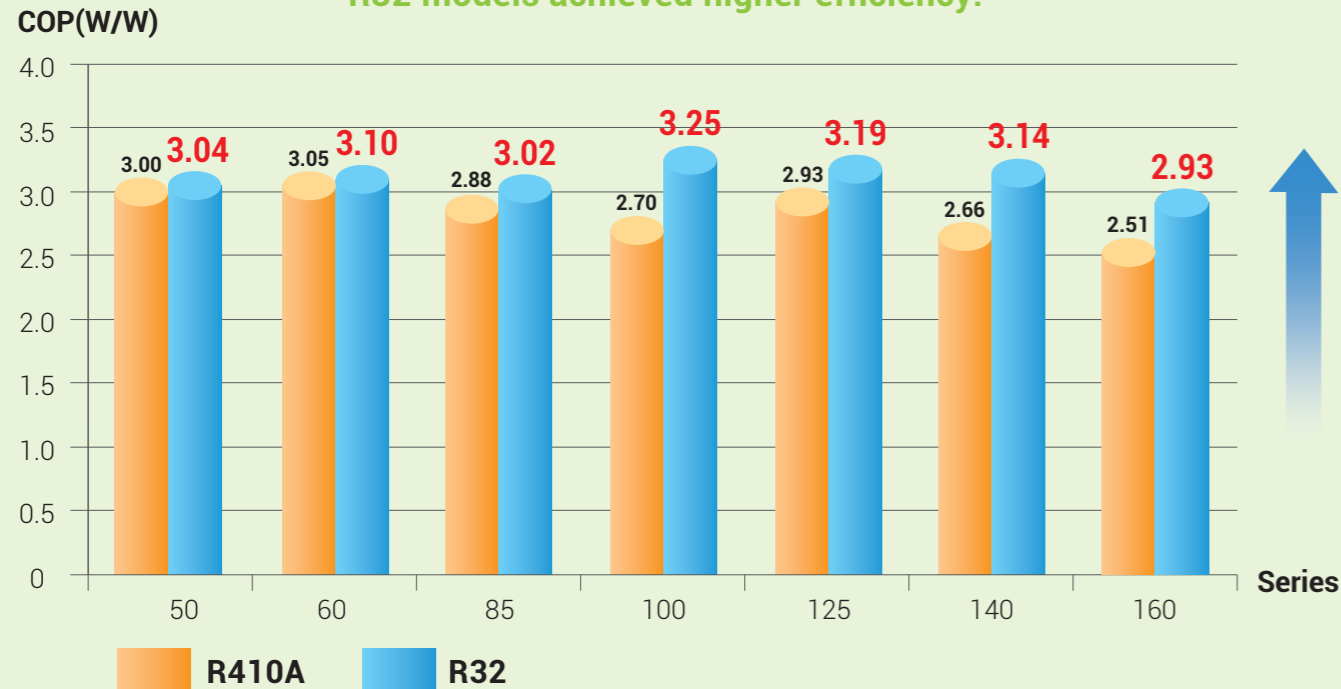

Comfort

Switchable Fan Speed: 3 Steps And Auto

- High setting provides maximum reach.
- Low setting minimises draft.



Horizontal And Vertical Air Swing

Airflow direction can be adjusted flexibly through horizontal and vertical louvers manually.

Air Flow

Far Air Throw

Maximum air throw distance up to 16.5m. (For 160 series)

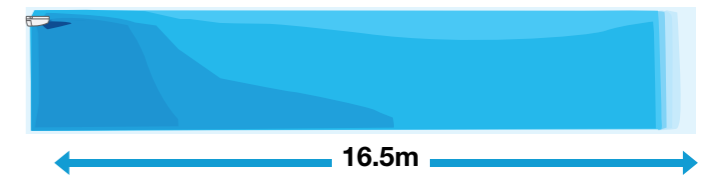

Easy Service Maintenance

Air Return Grille

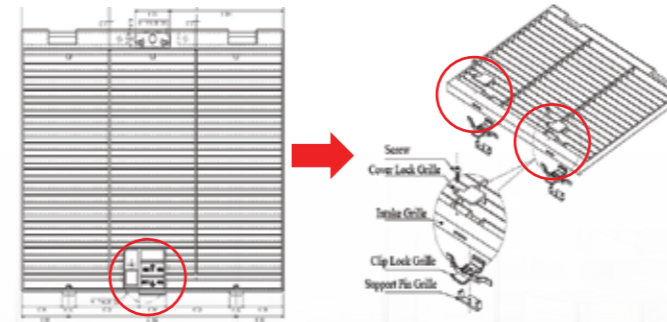

New Design - Easy to lock/unlock

Auto Random Restart With Last-State-Memory

- Once power resumes after a blackout, the unit will restart automatically at its last setting condition.
- This eliminates the need to restart manually after each power failure.

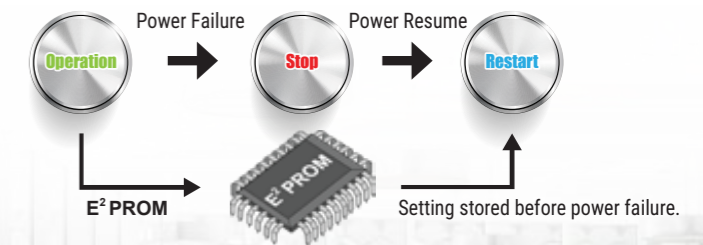

Design And Installation Flexibility

Installation Flexibility For Freedom Of Design

Uniform height and depth. Compact design for small-capacity models to meet tighter dimensional constraints.

Series	50/60	85	100/125/140	160
Height (mm)	235	235	235	285
Width (mm)	1,203	1,553	1,903	1,903
Depth (mm)	680	680	680	680

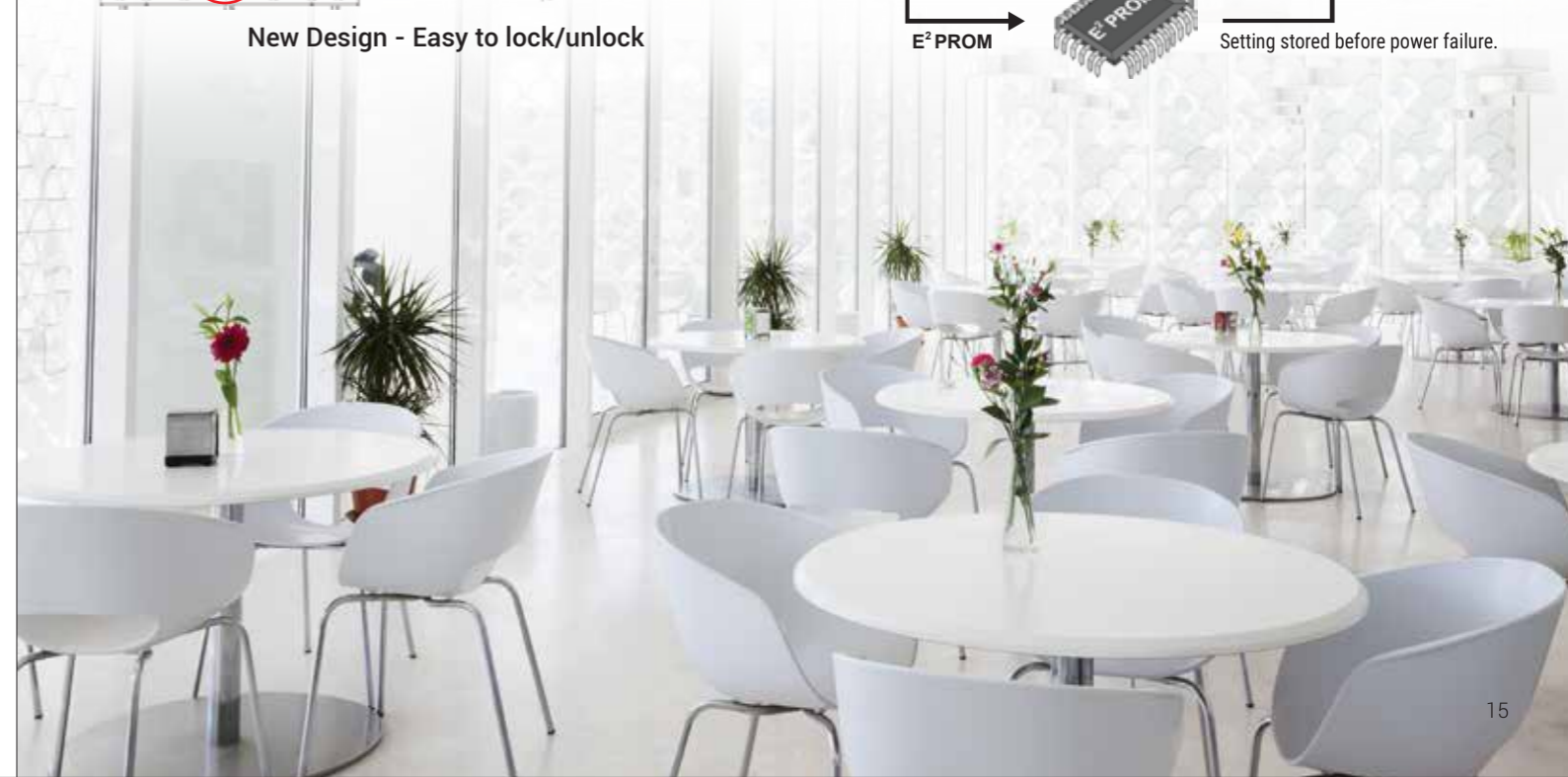

New OUTDOOR Features



RC50/60A



RC85A



RC100/125/140/160A

1. High Performance R32 Compressor

R32 Non Inverter SkyAir is utilizing high performance compressors to achieve high COP.



2. V-Cut Propeller Fan

Through the use of a V-cut propeller fan that imitates the efficiency of the swan, a migratory bird, airflow becomes smooth as friction loss is reduced. Therefore, performance increases tremendously. Furthermore, it reduces the sound pressure level as show below.



3. Quiet Operation

Series		50	60	85	100	125	140	160
Sound Pressure Level (dBA)	R32 model	52	52	54	56	58	60	62
	R410A model	52	52	56	58	60	60	65

4. High Durability

Outdoor Casing : Adopted zinc coated heavy gauge galvanized steel, with exterior surfaces finished with a weather resistant polyester powder casing, painted with ivory white colour to increase durability.

5. Longer Piping Length

Series	Max Piping Length	Max Piping Elevation
50	35	20
60	35	20
85	50	30
100	50	30
125	50	30
140	50	30
160	50	30

* Improved piping length to provide installation flexibility

6. 5+1 Years Warranty

Designed for durability and component quality, the units comes with 5 years warranty for compressor and 1 year warranty for general parts.



Ceiling Cassette



Ceiling Concealed



Ceiling Exposed

		Ceiling Cassette	Ceiling Concealed	Ceiling Exposed
Comfort Airflow	1 8-way Airflow Operation	●	–	–
	2 Auto Fan Speed	● 4 step	● 3 step	● 3 step
	3 Indoor Unit Quiet Operation	●	–	–
	4 Auto Swing	●	–	–
	5 Powerful Mode	●	●	●
Operation	6 Program Dry Function	●	●	●
	7 Fan Only	●	●	●
Lifestyle Convenience	8 Indoor Unit ON/OFF Button	●	–	●
	9 Signal Receiving Sign	●	–	●
	10 R/C With Back Light	●*1	●*1	●*1
Cleanliness	11 Saranet Filter	●	●*	●
	12 i-Plasma	●	–	–
	13 Washable Grille	●	–	●
Worry Free (Reliability & Durability)	14 Auto - Restart (After Power Failure)	●	●	●
	15 Self-Diagnosis (R/C, LED)	●	●	●
	16 Wiring Error Check Function	●	●	●
	17 Anti-Corrosion Treatment Of Outdoor Heat Exchanger (Gold Fin Option)	●	●	●
Flexibility	18 ESP Selection	–	●	–
	19 Water Pump (Water Drainage Pipe Flexibility)	●	●*	–
	20 F/°C Changeover R/C Temperature Display (Factory Setting: °C)	●	●	●
Remote Control	21 WEEKLY TIMER (Wired Controller)	●	●	●
	22 24-Hour ON/OFF TIMER	●	●	●
	23 NIM Adaptor	●	●	●
	24 Sequential NIM Adaptor	●	●	●
	25 Wireless	●	●*2	●
	26 Wired	●*	●	●*

- Not Available
- Standard
- * Optional
- *1 Optional and only applicable for SHIRO wired remote controller
- *2 Optional and the use of Wireless Controller requires the connection to Wired Controller to receive the signal



Comfort Airflow

8 Way Airflow

Discharge of air in 8 directions provides an even air distribution and fast cooling

Auto Fan Speed

Airflow rate is automatically controlled in accordance with the difference between room temperature and set temperature.

Auto Swing

Delivers comfortable air-conditioning to all areas, near to and far from the air conditioner. Airflow direction can be fixed at user's desired angle by remote controller.

Indoor Quiet Operation

Reduce background noise with Quiet Mode, which decreases the sound pressure level by setting fan speed to lowest.

Powerful Mode

Once activated, this feature will engage the indoor fan motor to run at maximum speed for 20 minutes. The turbo airflow enables the desired temperature to be achieved faster, especially in larger spaces.

Operation

Program Dry Function

Dehumidification is microprocessor controlled to prevent abrupt and uncomfortable changes in air temperature. Useful for reducing uncomfortable humidity without uncomfortable cooling of the room.

Fan Only

Unit will only operate with fan which provides airflow without supply of cool air.

Lifestyle Convenience

Indoor Unit ON/OFF Button

Unit can be switched on by pressing physical ON/OFF button on unit.

Signal Receiving Sign

Indication can be seen when air conditioner is switched on.

Remote Controller With Back Light

Lit up display for SHIRO wired controller allows user to use in the dark.

Cleanliness

Saranet Filter

Filter functions as standard dust filtration to trap dust in the air.

i-Plasma

Our advanced plasma ion technology purifies and sterilizes the air by effectively removing airborne contaminants, as well as deactivating harmful bacteria by damaging their microbial DNA and surface structures without causing harm to human.

Washable Grille

Ceiling Cassette grille can be detached easily and washed.

Worry Free

Auto-Restart With Surge Protection

If there is a sudden power failure, the unit will automatically restart with 64 different recovery patterns according to its last settings. This also prevents a sudden surge of electricity to your power source.

Self – Diagnosis Function

This intelligent feature helps to detect faults of malfunctioning in the system. Warning can be found through display error code in wired LCD remote controller. This information can be found in Installation Manual.

Wiring Error Check Function

Protection to prevent wrong wiring connection for 3 phase models.

Anti-Corrosion Treatment Outdoor (Gold Fin)

Gold fin offers increased corrosion resistance of outdoor fin.

Flexibility

ESP Selection

2-different ESP can be easily selected by switching the connector inside the control box. According to duct design required for comfort, the adjustment can be done easily during installation at control box.

Water Pump

High head drain pump of 700mm that enables higher elevation.

°F/°C Changeover

Set temperature can be set to °F or °C on remote controller.

Control

WEEKLY TIMER (Wired Controller)

Up to five operation ON/OFF settings and temperature settings can be programmed per day and each day of the week.

24-Hour ON/OFF TIMER

Operation starts when the preset time of ON timer elapses and stops when preset time of the OFF timer elapses.

NIM Adaptor

Group control by Network Interface module (NIM) for simultaneous control of up to 16 indoor units.

S-NIM

Sequential control by Sequential Network Interface Module (S-NIM) for sequential control of 2 indoor units at alternate sequence of pre-set hour.



FCC-A Series

Ceiling Cassette

Specifications

Model	Indoor unit		FCC50AV1M	FCC60AV1M	FCC85AV1M	
	Outdoor unit		RC50AV1M	RC60AV1M	RC85AV1M	
	Decoration panel	Wireless	BC50FM	BC50FM	BC50FM	
Rated Cooling Capacity		Btu/h		18,500	24,000	30,000
	kW		5.42	7.03	8.79	
Total Power		W	1,680	2,130	2,710	
Total Current		A	7.46	9.45	12.10	
COP		W/W	3.23	3.30	3.24	
CSPF		Wh/Wh	3.43	3.50	3.44	
Power supply		V/Ph/Hz	220-240/1/50	220-240/1/50	220-240/1/50	
Indoor	Airflow (H/M/L/Q)		cfm	840/700/560/440	890/760/620/490	890/760/620/490
			dBA	42/39/37/35	44/40/37/35	44/40/37/35
	Dimension (H x W x D)	Unit	mm	246 X 840 X 840	246 X 840 X 840	246 X 840 X 840
		With decortion panel	mm	305 X 950 X 950	305 X 950 X 950	305 X 950 X 950
	Unit Weight	Unit	kg	22	22	22
With decortion panel		kg	27	27	27	
Outdoor	Sound Pressure Level		dBA	52	52	54
	Dimension (H x W x D)		mm	615 X 845 X 300	615 X 845 X 300	695 X 930 X 350
	Unit Weight		kg	40	46	53
Pipe Connection Size	Liquid	mm	6.35	6.35	9.52	
Pipe Connection Size	Gas	mm	12.70	12.70	15.88	
Maximum Piping Length		m	35	35	50	
Maximum Piping Elevation		m	20	20	30	
Heat Insulation			Both Liquid and Gas Piping			

Model	Indoor unit		FCC100AV1M	FCC125AV1M	FCC140AV1M	
	Outdoor unit		RC100AV1M	RC125AY1M	RC140AY1M	
	Decoration panel	Wireless	BC50FM	BC50FM	BC50FM	
Rated Cooling Capacity		Btu/h		36,000	42,000	48,000
	kW		10.55	12.31	14.07	
Total Power		W	3,150	3,620	4,100	
Total Current		A	14.30	6.78	7.59	
COP		W/W	3.35	3.40	3.43	
CSPF		Wh/Wh	3.56	3.61	3.64	
Power supply		V/Ph/Hz	220-240/1/50	380-415/3/50	380-415/3/50	
Indoor	Airflow (H/M/L/Q)		cfm	1,120/1,030/890/760	1,120/1,030/890/760	1,120/1,030/890/760
			dBA	48/46/43/40	48/46/43/40	48/46/43/40
	Dimension (H x W x D)	Unit	mm	288 X 840 X 840	288 X 840 X 840	288 X 840 X 840
		With decortion panel	mm	347 X 950 X 950	347 X 950 X 950	347 X 950 X 950
	Unit Weight	Unit	kg	25	25	25
With decortion panel		kg	30	30	30	
Outdoor	Sound Pressure Level		dBA	56	58	60
	Dimension (H x W x D)		mm	852 X 1,030 X 400	852 X 1,030 X 400	852 X 1,030 X 400
	Unit Weight		kg	62	79	84
Pipe Connection Size	Liquid	mm	9.52	9.52	9.52	
Pipe Connection Size	Gas	mm	15.88	15.88	15.88	
Maximum Piping Length		m	50	50	50	
Maximum Piping Elevation		m	30	30	30	
Heat Insulation			Both Liquid and Gas Piping			

Remarks:

1. Due to product innovation, all specifications are subjected to change by the manufacturer without prior notice.
2. All units are being tested and comply to ISO5151.
3. Nominal cooling capacity are based on the conditions: 27°C DB / 19°C WB indoor and 35°C DB outdoor.
4. Sound pressure levels are measured in anechoic chamber according to JIS C 9612 standard and JIS B 8616. During actual operation, sound pressure level will be higher as a result of room specification condition.
5. RC100AV1M and RC125/140AY1M are equipped with contactor for Direct On Line (DOL) field installation.



FDMC-A Series

Ceiling Concealed Specifications

Model	Indoor unit		FDMC50AV1M	FDMC60AV1M	FDMC85AV1M
	Outdoor unit		RC50AV1M	RC60AV1M	RC85AV1M
Rated Cooling Capacity		Btu/h	18,500	23,500	30,000
		kW	5.42	6.89	8.79
Total Power		W	1,750	2,290	2,770
Total Current		A	7.74	10.3	12.4
COP		W/W	3.10	3.01	3.17
CSPF		Wh/Wh	3.29	3.20	3.37
Power supply		V/Ph/Hz	220-240/1/50	220-240/1/50	220-240/1/50
Indoor	Airflow (H/M/L)		cfm 590/525/430	590/525/430	950/810/700
	External Static Pressure (Std/High)		Pa 30/50	30/50	30/50
	Sound Pressure Level (H/M/L)		dBA 40/37/34	40/37/34	41/38/35
	Dimension (H x W x D)	Unit	mm 250 X 700 X 700	250 X 700 X 700	250 X 1,000 X 700
	Unit Weight	Unit	kg 24	24	31
Outdoor	Sound Pressure Level		dBA 52	52	54
	Dimension (H x W x D)		mm 615 X 845 X 300	615 X 845 X 300	695 X 930 X 350
	Unit Weight		kg 40	46	53
Pipe Connection Size	Liquid	mm 6.35	6.35	9.52	
Pipe Connection Size	Gas	mm 12.70	12.70	15.88	
Maximum Piping Length		m 35	35	50	
Maximum Piping Elevation		m 20	20	30	
Heat Insulation	Both Liquid and Gas Piping				

Model	Indoor unit		FDMC100AV1M	FDMC125AV1M	FDMC140AV1M	FDMC160AV1M
	Outdoor unit		RC100AV1M	RC125AY1M	RC140AY1M	RC160AY1M
Rated Cooling Capacity		Btu/h	36,000	42,000	48,000	55,000
		kW	10.55	12.31	14.07	16.12
Total Power		W	3,200	3,660	4,100	4,950
Total Current		A	14.80	6.85	7.51	8.73
COP		W/W	3.30	3.36	3.43	3.26
CSPF		Wh/Wh	3.50	3.57	3.64	3.46
Power supply		V/Ph/Hz	220-240/1/50	380-415/3/50	380-415/3/50	380-415/3/50
Indoor	Airflow (H/M/L)		cfm 1,260/1,095/920	1,260/1,095/920	1,260/1,095/920	1,400/1,280/1,120
	External Static Pressure (Std/High)		Pa 50/80	50/80	50/80	50/60
	Sound Pressure Level (H/M/L)		dBA 42/39/36	42/39/36	42/39/36	43/42/39
	Dimension (H x W x D)	Unit	mm 250 X 1,400 X 700	250 X 1,400 X 700	250 X 1,400 X 700	250 X 1,400 X 700
	Unit Weight	Unit	kg 40	40	42	44
Outdoor	Sound Pressure Level		dBA 56	58	60	62
	Dimension (H x W x D)		mm 852 X 1,030 X 400	852 X 1,030 X 400	852 X 1,030 X 400	852 X 1,030 X 400
	Unit Weight		kg 62	79	84	94
Pipe Connection Size	Liquid	mm 9.52	9.52	9.52	9.52	
Pipe Connection Size	Gas	mm 15.88	15.88	15.88	19.05	
Maximum Piping Length		m 50	50	50	50	
Maximum Piping Elevation		m 30	30	30	30	
Heat Insulation	Both Liquid and Gas Piping					

Remarks:

1. Due to product innovation, all specifications are subjected to change by the manufacturer without prior notice.
2. All units are being tested and comply to ISO13253.
3. Nominal cooling capacity are based on the conditions: 27°C DB / 19°C WB indoor and 35°C DB outdoor.
4. Sound pressure levels are measured in anechoic chamber according to JIS C 9612 standard and JIS B 8616. During actual operation, sound pressure level will be higher as a result of room specification condition.
5. RC100AV1M and RC125/140AY1M are equipped with contactor for Direct On Line (DOL) field installation.



FHC-A Series

Ceiling Exposed Specifications

Model	Indoor unit		FHC50AV1M	FHC60AV1M	FHC85AV1M
	Outdoor unit		RC50AV1M	RC60AV1M	RC85AV1M
Rated Cooling Capacity		Btu/h	18,500	23,500	29,500
		kW	5.42	6.89	8.65
Total Power		W	1,785	2,220	2,860
Total Current		A	8.05	9.88	12.80
COP		W/W	3.04	3.10	3.02
CSPF		Wh/Wh	3.23	3.29	3.21
Power supply		V/Ph/Hz	220-240/1/50	220-240/1/50	220-240/1/50
Indoor	Airflow (H/M/L)		cfm 620/600/490	620/600/490	830/730/625
	Sound Pressure Level (H/M/L)		dBA 47/46/43	47/46/43	48/45/42
	Dimension (H x W x D)	Unit	mm 235 X 1,203 X 680	235 X 1,203 X 680	235 X 1,553 X 680
	Unit Weight	Unit	kg 33	33	41
Outdoor	Sound Pressure Level		dBA 52	52	54
	Dimension (H x W x D)		mm 615 X 845 X 300	615 X 845 X 300	695 X 930 X 350
	Unit Weight		kg 40	46	53
Pipe Connection Size	Liquid	mm 6.35	6.35	9.52	
Pipe Connection Size	Gas	mm 12.70	12.70	15.88	
Maximum Piping Length		m 35	35	50	
Maximum Piping Elevation		m 20	20	30	
Heat Insulation	Both Liquid and Gas Piping				

Model	Indoor unit		FHC100AV1M	FHC125AV1M	FHC140AV1M	FHC160AV1M
	Outdoor unit		RC100AV1M	RC125AY1M	RC140AY1M	RC160AY1M
Rated Cooling Capacity		Btu/h	36,000	42,000	46,000	55,000
		kW	10.55	12.31	13.48	16.12
Total Power		W	3,250	3,860	4,300	5,500
Total Current		A	14.70	7.14	7.93	9.62
COP		W/W	3.25	3.19	3.14	2.93
CSPF		Wh/Wh	3.45	3.39	3.33	3.11
Power supply		V/Ph/Hz	220-240/1/50	380-415/3/50	380-415/3/50	380-415/3/50
Indoor	Airflow (H/M/L)		cfm 1,125/1,030/960	1,125/1,030/960	1,125/1,030/960	1,460/1,390/1,150
	Sound Pressure Level (H/M/L)		dBA 52/50/48	52/50/48	52/50/48	55/53/50
	Dimension (H x W x D)	Unit	mm 235 X 1,903 X 680	235 X 1,903 X 680	235 X 1,903 X 680	285 X 1,903 X 680
	Unit Weight	Unit	kg 50	50	50	60
Outdoor	Sound Pressure Level		dBA 56	58	60	62
	Dimension (H x W x D)		mm 852 X 1,030 X 400	852 X 1,030 X 400	852 X 1,030 X 400	852 X 1,030 X 400
	Unit Weight		kg 62	79	84	94
Pipe Connection Size	Liquid	mm 9.52	9.52	9.52	9.52	
Pipe Connection Size	Gas	mm 15.88	15.88	15.88	19.05	
Maximum Piping Length		m 50	50	50	50	
Maximum Piping Elevation		m 30	30	30	30	
Heat Insulation	Both Liquid and Gas Piping					

Remarks:

1. Due to product innovation, all specifications are subjected to change by the manufacturer without prior notice.
2. All units are being tested and comply to ISO5151.
3. Nominal cooling capacity are based on the conditions: 27°C DB / 19°C WB indoor and 35°C DB outdoor.
4. Sound pressure levels are measured in anechoic chamber according to JIS C 9612 standard and JIS B 8616. During actual operation, sound pressure level will be higher as a result of room specification condition.
5. RC100AV1M and RC125/140AY1M are equipped with contactor for Direct On Line (DOL) field installation.