



# LD VALVE

INDUSTRIAL ASTM & DIN  
PVC/CPVC PIPING SYSTEMS



BRITISH  
STANDARD  
APPROVED  
BS EN200 : 2008  
BS 1010-2 : 1973



**SINCE 1974 TAIWAN**





## PREFACE

In 1974, LD VALVE CO., LTD. was founded as a thermoplastic piping systems manufacturer with in-house label brand "LD", is the pioneer of the flow control industry.

We are recognized in over 100 countries and continue to expand every day. The "LD" brand name is synonymous with the highest standards of quality products, customer satisfaction and competitive pricing.

For over one-third of a century, LD offers excellent quality of flow control products. LD is poised for ongoing growth through the continual pursuit of quality improvement in the products and services provided to the customers.

Though times have changed, one thing has remained certain, this drive for success stems from an originating belief in three basic core values:

1. Absolute Quality.
2. Absolute Customer Satisfaction.
3. Absolute Continuous Research & Development.

LD will continue leading the flow control industry for years to come, backed up by over 40 years experience, the latest computer technology and integrated ERP. We believe all customers deserve to receive the absolute highest quality of products and service. We will always strive to make all our customers smile.

## QUIENES SOMOS

En 1974, LD VALVE CO., LTD. fue fundada como fabricante de sistemas de tuberías termoplásticas llevando su propia marca "LD", son pioneros en la industria de control de flujo.

Reconocida en más de 100 países y continuar ampliando cada día. La marca "LD" es sinónimo de los más altos estándares de productos de calidad, satisfacer a los clientes y precios competitivos.

Durante más de un tercio de siglo, LD ofrece productos de excelente calidad en el control de flujo. LD está basado en su constante crecimiento mediante la consecución de mejorar la calidad de sus productos y el servicio que presta a sus clientes. Aunque los tiempos han cambiado, una cosa ha permanecido determinada, el éxito se deriva de una creencia originaria de tres valores fundamentales bases:

1. Calidad Absoluta.
2. Satisfacción Absoluto a los Clientes.
3. Continuidad Absoluta en Desarrollo e Investigación.

LD continuará liderando la industria de control de flujo en los próximos años, respaldada por más de 40 años de experiencia, integrado por última tecnología computarizada al sistema planificación de investigación de la empresa (ERP). Creemos que todos los clientes merecen recibir los productos y servicios de la más alta calidad absoluta. Siempre haremos nuestros esfuerzos para tener las sonrisas de nuestros clientes.

## CERTIFICATION

ISO 9001:2008



NSF approved



Australian Water Quality Centre



Fugro Technical Certificate





## MATERIAL TECHNICAL INFORMATION

### PVC-Poly Vinyl Chloride

PVC is by far the most common thermoplastics material used for piping systems components, including valves, fittings, flanges and many specialty products. PVC has excellent chemical and corrosion resistance to broad range of fluids including acids, bases and salts. PVC is resistant to hydrocarbons and alcohol, etc. However it can be attacked by many organic chemicals. The maximum recommended service temperature of PVC products is 60°C (140°F). PVC is joined by solvent cementing, threading and flanging.

### CPVC-Chlorinated Poly Vinyl Chloride

Chlorinated PVC is used for higher temperature applications than PVC, especially for handling hot corrosive liquids. With similar chemical and corrosion resistance to PVC, increased chlorine content gives CPVC superior thermal resistance. CPVC is not recommended for use with chlorinated or aromatic hydrocarbons, esters, or polar solvents such as ketenes. The maximum recommended service temperature of CPVC products is 93°C (200°F). CPVC is proven to be an excellent material for hot corrosive liquids, hot and cold-water distribution. CPVC is joined by solvent cementing, threading and flanging.

## AMERICAN NATIONAL STANDARDS

### ASTM – AMERICAN SOCIETY FOR TESTING AND MATERIALS

#### ASTM STANDARD D1784

This standard covers compound requirements of PVC and CPVC used in the manufacture of thermoplastic pipe, valves and fittings. It provides a means for selecting and identifying compounds on the basis of a number of physical and chemical criteria.

Conformance to a particular material classification in this standard requires meeting the minimum physical and chemical properties.

#### ASTM STANDARD D 2464

This standard has been combined with ASTM D 2467.

#### ASTM STANDARD D2467

This standard covers Schedule 80 PVC threaded and socket pressure fittings. Included in the standard are thread and socket specifications, lay length, wall thickness, burst pressure, quality, and identification requirements.

#### ASTM STANDARD D 2564

This standard covers requirements for PVC solvent cement, including component compounds, viscosity, minimum resin content and physical performance.

#### ASTM STANDARD D 2855

This standard covers practice and procedures for applying solvent cement on PVC pipe and fitting joints.

#### ASTM STANDARD F 1498

This standard covers fittings and appurtenances intended to be used in PVC or CPVC thermoplastic piping, or as a transition from such system to metal system. These products, such as union, flanges, or valves, are not included in the scope of other ASTM specifications.

#### ASTM STANDARD F 1970

This standard covers end connection dimensions and performance criteria testing for products such as thermoplastic ball valves and check valves.

## ANSI – AMERICAN NATIONAL STANDARDS INSTITUTE

#### ANSI STANDARD B1.20.1

This standard covers tolerance, taper and basic thread form of general purpose tapered pipe threads (metal).

#### ANSI STANDARD B16.5

The standard covers the pressure-temperature ratings, materials, dimensions, tolerances, marking testing and methods of designating openings for pipe flanges and flanged fittings. The requirements and recommendations regarding flange bolting, flange gaskets, and flange joints are also included. It includes the rating class designations 150, 300, 400, 600, 900, 1500 and 2500 in sizes NPS 1/2 through NPS 24 in both metric and U.S. units. However, it has the limitation from certain reducing flanges made from cast, forged or plate materials.



## NSF INTERNATIONAL

NSF is a third party agency for product approving. They use manufacturer's products in different tests to analyze if they accomplish a variety of health and product performance standards. Among all the agencies who issues approval of thermoplastic piping systems products for potable water use, they are one of the most recognized.

### NSF STANDARD 14

This standard establishes the minimum physical properties and performance requirements for thermoplastic piping systems components and related materials. It also provides a basis for certification of products to consensus standard, or other physical and performance requirements where no consensus standard exists. It requires adherence to appropriate ASTM standard and specifies minimum quality control programs. To comply with this standard the manufacturer must allow periodic testing of product and auditing of procedures by a third-party agency.

### NSF STANDARD 14 SPECIAL ENGINEERING APPURTENANCE PROGRAM (S.E.)

Apart from Standard 14 requirements, the S.E. program establishes other performance requirements for those specifications that are not indicated in ASTM standard. NSF S.E. program is developed bases on a combination of applicable part of ASTM standards and manufacturer's design specifications for conformance verification.

### NSF STANDARD 61

This standard establishes the minimum requirement that control potential harmful health effects from products that will contact drinking water while in use. Products that are certified with this standard have been through contaminates or impurities tests and are suitable for use with potable water. This is a prerequisite standard before NSF Standard 14 certification.

## DIN STANDARD - DEUTSCHES INSTITUT FÜR NORMUNG (GERMAN INSTITUTE FOR STANDARDIZATION)

### DIN 2999

This standard covers the specifications of pipe threads for threaded pipes and fittings. Include parallel female thread and tapered male thread.

### DIN 8061 UNPLASTICIZED POLYVINYL CHLORIDE (PVC-U) PIPES – GENERAL QUALITY REQUIREMENTS AND TESTING

This standard covers the general requirements for testing UPVC pipes

### DIN 8062 UNPLASTICIZED POLYVINYL CHLORIDE (PVC-U) PIPES – DIMENSIONS

This standard covers the dimensions for testing UPVC pipes

### DIN 8063 PIPE JOINTS AND THEIR ELEMENTS FOR PIPES OF RIGID PVC (RIGID POLYVINYLCHLORIDE) UNDER PRESSURE; BENDS FOR PIPES OF RIGID PVC, DIMENSIONS

These standards cover the general requirements and dimensions for testing fittings.

### DIN 8079 CHLORINATED POLYVINYL CHLORIDE (PVC-C) PIPES – DIMENSIONS

This standard covers the dimensions for testing CPVC pipes

### DIN 8080 CHLORINATED POLYVINYL CHLORIDE (PVC-C) PIPES - GENERAL QUALITY REQUIREMENTS, TESTING

This standard covers the general requirements for testing CPVC pipes

## WELD-LINE

At the moment of installation, when you find the visible line in the product just received, please do not panic, it is often mistaken for a crack. First you need to concern is whether the product is defective or is just the weld-line from the injection molding process.

The difference between the cracks and weld line is the weld-line, bond -line or the knit-line is the intersection where two flow fronts meet around the core and bonds or knits together.

As the resin enters the injection barrel, the resin melt as when the turning screw drags it toward the end.

Injection molded products are made when pellet rotates within a barrel with heat and friction and become the molten plastic. The hot melted plastic flows into the mold cavity and is diverted around a core, the line is created when the leading edges of molten plastic joint together. The melt fronts is cooler than the original melt temperature and when the cooled skin bonds or knits together create the weld-line, bond-line, or so called the knit-lin.

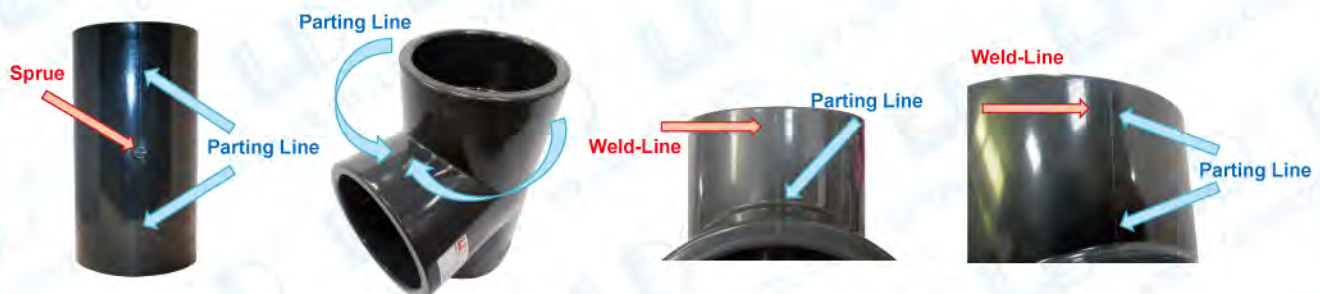



## Friction Loss for Industrial ASTM & DIN Piping

**Note:** Independent variables: Gallons per minute and nominal O.D. pipe size  
 Dependent variables: Velocity, friction head and pressure drop per 100 feet of pipe, interior smooth.

Flow Rate Gallon/min Liter/min	1 1/2" (38mm)	2" (51mm)	3" (76mm)	4" (102mm)	5" (127mm)	6" (152mm)	8" (203mm)	10" (254mm)	12" (305mm)	14" (355mm)	16" (406mm)	Friction Head Loss feet/100ft	Friction Head Loss psi/100ft	Flow Velocity V feet/sec	Friction Loss psi/100ft	Flow Velocity V feet/sec	Friction Loss psi/100ft	Flow Velocity V feet/sec	Friction Loss psi/100ft	Flow Velocity V feet/sec	Friction Loss psi/100ft	Flow Velocity V feet/sec	Friction Loss psi/100ft	Flow Velocity V feet/sec	Friction Loss psi/100ft			
1	3.8	1.48	2.24	0.97																								
2	7.6	2.95	4.48	1.73	0.75																							
5	18.9	7.39	11.2	4.12	3.92	9.45	4.10	2.33	2.67	1.16																		
7	26.5	10.34	15.27	5.66	5.49	17.62	7.64	3.27	4.98	2.16	1.82	1.20	0.52															
10	37.9	14.77	21.71	7.92	7.84	24.11	10.60	4.67	6.85	3.00	2.59	1.68	0.75															
15	56.8																											
20	75.7																											
25	94.6																											
30	114	0.86	0.08	0.03																								
35	132	1.00	0.11	0.05																								
40	151	1.14	0.14	0.06																								
45	170	1.28	0.17	0.07																								
50	189	1.43	0.21	0.09	0.90	0.07	0.03																					
60	227	1.71	0.30	0.13	1.08	0.10	0.04																					
70	265	2.00	0.39	0.17	1.26	0.13	0.06																					
75	284	2.14	0.45	0.20	1.35	0.15	0.07																					
80	303	2.28	0.51	0.22	1.44	0.16	0.07																					
90	341	2.57	0.63	0.27	1.62	0.20	0.09	1.13	0.09	0.04																		
100	379	2.85	0.76	0.33	1.80	0.25	0.11	1.25	0.10	0.04																		
125	473	3.56	1.16	0.50	2.25	0.38	0.16	1.57	0.16	0.07																		
150	568	4.28	1.62	0.70	2.70	0.53	0.23	1.88	0.22	0.10	1.07	0.06	0.03															
175	662	4.99	2.16	0.94	3.15	0.70	0.30	2.19	0.29	0.13	1.25	0.07	0.03															
200	757	5.70	2.76	1.20	3.60	0.90	0.39	2.51	0.37	0.16	1.43	0.10	0.04															
250	946	7.13	4.17	1.81	4.49	1.36	0.59	3.13	0.57	0.25	1.79	0.14	0.06															
300	1136	8.55	5.85	2.54	5.39	1.90	0.82	3.76	0.79	0.34	2.14	0.20	0.09	1.36	0.07	0.03												
350	1325	9.98	7.78	3.37	6.29	2.53	1.10	4.39	1.05	0.46	2.50	0.27	0.12	1.59	0.09	0.04												
400	1514	11.41	9.96	4.32	7.19	3.24	1.40	5.02	1.35	0.59	2.86	0.34	0.15	1.81	0.11	0.05												
450	1703				8.09	4.04	1.75	5.64	1.68	0.73	3.21	0.43	0.19	2.04	0.14	0.06												
500	1893				8.99	4.90	2.12	6.27	2.04	0.88	3.57	0.52	0.23	2.27	0.17	0.07												
750	2839																											
1000	3785	1.59	0.05	0.02																								
1250	4731	1.99	0.07	0.03	1.61	0.04	0.02																					
1500	5678	2.39	0.10	0.04	1.93	0.06	0.03																					
2000	7570	3.19	0.18	0.08	2.58	0.10	0.04	1.78	0.04	0.02																		
2500	9463	3.98	0.27	0.12	3.22	0.16	0.07	2.23	0.09	0.03																		
3000	11355	4.78	0.37	0.16	3.86	0.22	0.10	2.67	0.16	0.04																		
3500	13248	5.58	0.50	0.22	4.51	0.30	0.13	3.12	0.21	0.05																		
4000	15140	6.37	0.64	0.28	5.15	0.38	0.16	3.56	0.15	0.07																		
4500	17033	7.17	0.79	0.34	5.80	0.47	0.20	4.01	0.19	0.08																		
5000	18925	7.97	0.96	0.42	6.44	0.57	0.25	4.45	0.23	0.10																		
5500	20818	8.77	1.15	0.50	7.08	0.68	0.29	4.90	0.28	0.12																		
6000	22710	9.56	1.35	0.59	7.73	0.80	0.35	5.35	0.33	0.14																		
6500	24603	10.36	1.56	0.68	8.37	0.93	0.40	5.79	0.38	0.16																		
7000	26495	11.13	1.79	0.78	9.02	1.07	0.46	6.24	0.44	0.19																		
7500	28388				9.66	1.21	0.52	6.68	0.49	0.21																		
8000	30280				10.30	1.37	0.59	7.13	0.56	0.24																		
8500	32173				7.57	0.62	0.27																					
9000	34065				8.02	0.69	0.30																					
9500	35958				8.46	0.77	0.33																					
10000	37850				8.91	0.84	0.36																					



## LD-500 INDUSTRIAL ASTM & DIN - PVC/CPVC PIPE

LD Thermoplastic Pipe is Manufactured by the Following Standard Specifications

TYPE	MATERIAL STD.	DIMENSIONS	CELL CLASSIFICATION
PVC	ASTM D 1784	ASTM D 1785 DIN 8061/62	TYPE I, GRADE 1, PVC 12454
CPVC	ASTM D 1784	ASTM F 441 DIN 8079/80	TYPE IV, GRADE 1, CPVC 23447



### Schedule 80 PVC ASTM D1785 and CPVC ASTM F441 Pipe Dimensions, Weights and Maximum Operation Pressure

NOMINAL PIPE SIZE	OUTSIDE DIAMETER		WALL THICKNESS		APPROX. INSIDE DIAMETER	NOMINAL WEIGHT		MAX. OPERATING PRESSURE
						PVC	CPVC	
inch	inch		inch		inch	lb/ft	lb/ft	psi
1/2"	0.840	±0.004	0.147	±0.020	0.53	0.21	0.23	850
3/4"	1.050	±0.004	0.154	±0.020	0.72	0.28	0.31	690
1"	1.315	±0.005	0.179	±0.021	0.94	0.41	0.45	630
1-1/4"	1.660	±0.005	0.191	±0.023	1.26	0.57	0.62	520
1-1/2"	1.900	±0.006	0.200	±0.024	1.48	0.69	0.76	470
2"	2.375	±0.006	0.218	±0.026	1.91	0.96	1.05	400
2-1/2"	2.875	±0.007	0.276	±0.033	2.29	1.46	1.60	420
3"	3.500	±0.008	0.300	±0.036	2.86	1.96	2.14	370
4"	4.500	±0.009	0.337	±0.040	3.79	2.86	3.12	320
5"	5.563	±0.010	0.375	±0.045	4.77	3.97	4.34	290
6"	6.625	±0.011	0.432	±0.052	5.71	5.46	5.96	280
8"	8.625	±0.015	0.500	±0.060	7.57	8.30	9.06	250
10"	10.75	±0.015	0.593	±0.071	9.49	12.30	13.43	230
12"	12.75	±0.015	0.687	±0.082	11.29	16.93	18.48	230
14"	14.00	±0.015	0.750	±0.090	12.41	20.30	22.16	220
16"	16.00	±0.019	0.843	±0.101	14.21	26.10	28.49	220
18"	18.00	±0.019	0.937	±0.112	16.01	32.66	35.65	220
20"	20.00	±0.023	1.031	±0.124	17.81	39.97	43.63	220
24"	24.00	±0.031	1.218	±0.146	21.42	56.70	61.89	210

### PVC DIN 8061/62 and CPVC DIN 8079/80 Pipe Dimensions, Weight and Maximum Operation Pressure

NOMINAL PIPE SIZE	OUTSIDE DIAMETER		WALL THICKNESS		APPROX. INSIDE DIAMETER	NOMINAL WEIGHT		MAX. OPERATING PRESSURE
						PVC	CPVC	
mm	mm		mm		mm	lb/ft	lb/ft	psi
20	20	+0.2	1.5	+0.4	16.80	0.22	0.24	850
25	25	+0.2	1.9	+0.4	21.00	0.29	0.33	690
32	32	+0.2	2.4	+0.5	26.95	0.43	0.47	630
40	40	+0.2	3.0	+0.5	33.75	0.60	0.65	520
50	50	+0.2	3.7	+0.6	42.30	0.72	0.80	470
63	63	+0.2	4.7	+0.7	53.25	1.01	1.10	400
75	75	+0.3	5.6	+0.8	63.40	1.53	1.68	420
90	90	+0.3	6.7	+0.9	76.15	2.06	2.25	370
110	110	+0.3	8.2	+1.1	93.05	3.00	3.28	320
125	125	+0.4	9.3	+1.2	105.80	3.15	3.44	290
140	140	+0.4	10.4	+1.3	118.55	4.17	4.56	280
160	160	+0.4	11.9	+1.4	135.50	5.73	6.26	280
180	180	+0.4	13.4	+1.6	152.40	6.31	6.88	280
200	200	+0.4	14.9	+1.7	169.35	6.94	7.57	250
225	225	+0.5	16.7	+1.3	190.95	8.72	9.51	250
250	250	+0.5	18.6	+2.1	211.75	9.59	10.46	230
280	280	+0.6	20.8	+2.3	237.25	12.92	14.10	230
315	315	+0.6	23.4	+2.6	266.90	17.78	19.40	220
355	355	+0.7	26.3	+2.9	300.95	21.32	23.27	220
400	400	+0.7	29.7	+3.2	339.00	27.41	29.91	220

NOTE: Maximum Operation Pressure is applied to 73°F/22°C.



## Specification

LD's clear PVC pipe and fittings provide an excellent solution for monitoring the flow of fluid in the piping systems. Thermoplastic piping systems are known for their superior corrosion resistance, fast and reliable solvent-welded connection, non-contaminating, non-conductive, light weight, good pressure handling capacity, high impact resistance and so on. Our clear piping systems come in handy when continuous monitoring is required. They are manufactured according to Sch. 40 and Sch. 80 dimensions which offer sufficient wall thickness for most pressure application without sacrificing clarity.



### Clear LD Thermoplastic PVC Pipe is Manufactured to the Following Standard Specifications

TYPE	MATERIAL STD.	DIMENSIONS	CELL CLASSIFICATION
<b>SCHEDULE 80</b>	ASTM D1784	ASTM D1785	TYPE I, GRADE 1, PVC 12454
<b>SCHEDULE 40</b>	ASTM D1784	ASTM D1785	TYPE I, GRADE 1, PVC 12454

### Clear SCHEDULE 80 PVC Pipe Dimensions

PIPE SIZE		OUTSIDE DIAMETER		WALL THICKNESS		APPROX. INSIDE DIAMETER	NOMINAL WEIGHT	MAX. OPERATING PRESSURE
inch	mm	inch		inch		inch	lb/ft	psi
1/2"	20	0.84	±0.004	0.147	±0.020	0.53	0.21	420
3/4"	25	1.050	±0.004	0.154	±0.020	0.72	0.28	340
1"	32	1.315	±0.005	0.179	±0.021	0.94	0.41	320
1-1/4"	40	1.660	±0.005	0.191	±0.023	1.26	0.57	260
1-1/2"	50	1.900	±0.006	0.200	±0.024	1.48	0.69	240
2"	63	2.375	±0.006	0.218	±0.026	1.91	0.96	200
2-1/2"	75	2.875	±0.007	0.276	±0.033	2.29	1.46	210
3"	90	3.500	±0.008	0.300	±0.036	2.86	1.96	190
4"	110	4.500	±0.009	0.337	±0.040	3.79	2.86	160
6"	160	6.625	±0.011	0.432	±0.052	5.71	5.46	140

### Clear SCHEDULE 40 PVC Pipe Dimensions

NOMINAL PIPE SIZE		OUTSIDE DIAMETER		WALL THICKNESS		APPROX. INSIDE DIAMETER	NOMINAL WEIGHT	MAX. OPERATING PRESSURE
inch	mm	inch		inch		inch	lb/ft	psi
1/2"	20	0.840	±0.004	0.109	±0.020	0.60	0.17	300
3/4"	25	1.050	±0.004	0.113	±0.020	0.80	0.23	240
1"	32	1.315	±0.005	0.133	±0.020	1.03	0.33	220
1-1/4"	40	1.660	±0.005	0.140	±0.020	1.36	0.45	180
1-1/2"	50	1.900	±0.006	0.145	±0.020	1.59	0.54	170
2"	63	2.375	±0.006	0.154	±0.020	2.05	0.72	140
2-1/2"	75	2.875	±0.007	0.203	±0.024	2.45	1.14	150
3"	90	3.500	±0.008	0.216	±0.026	3.04	1.49	130
4"	110	4.500	±0.009	0.237	±0.028	4.00	2.12	110
6"	160	6.625	±0.011	0.280	±0.034	6.03	3.73	90
8"	200/225	8.625	±0.015	0.322	±0.039	7.94	5.62	80
10"	250/280	10.750	±0.015	0.365	±0.044	9.98	7.97	70
12"	315	12.750	±0.015	0.406	±0.049	11.89	10.53	70

## Material

LD uses only rigid, virgin Polyvinyl Chloride (PVC) compound for manufacturing our products. This material provides the best impact and pressure resistance with a maximum working temperature of 140°F/60°C.

## Joining Method

LD's clear PVC pipe and fittings could be easily joined with standard solvent cementing process. For maintaining the best clarity, LD recommends use of clear, medium-bodied, fast-setting cement in conjunction with a clear primer for optimum joint integrity.



## De-Rating Factor

OPERATING TEMPERATURE	DE-RATING FACTOR
73°F / 22°C	1.00
80°F / 27°C	0.88
90°F / 32°C	0.75
100°F / 40°C	0.62
110°F / 44°C	0.51
120°F / 49°C	0.40
130°F / 55°C	0.31
140°F / 60°C	0.22

De-rating factor should be multiplied when the operating temperature is higher than 73°F/22°C.

It is used to determine maximum working pressure of the system at elevated temperatures.

EX.: 2" PVC Schedule 80 Clear @ 100°F/40°C

200 psi x 0.62 = 124 psi maximum @ 100°F/40°C

## Critical Collapse Pressure PSI@73°F/22°C

PIPE SIZE		SCHEDULE 40	SCHEDULE 80
inch	mm		
1/2"	20	3,255	9,370
3/4"	25	1,722	4,985
1"	32	1,399	3,841
1-1/4"	40	767	2,158
1-1/2"	50	554	1,599
2"	63	327	1,014
2-1/2"	75	431	1,176
3"	90	279	809
4"	110	169	521
6"	160	84	333
8"	200/225	57	-
10"	250/280	43	-
12"	315	35	-

The Critical Collapse Pressure table is a reference to the maximum pressure that could be applied to the pipe externally. This factor is used when the system is buried underground, underwater. Values in psi are evaluated at 73°F/22°C with no safety factor. While designing a system for higher working temperature, de-rating factor should be applied.

## Properties of CLEAR PVC Pipe

ITEM			
GENERAL	VALUE	unit	TEST METHOD
Cell Classification	12454	-	ASTM D 1784
Maximum Service Temperature	140	°F	-
Specific Gravity @73°F (22°C)	1.33	g/cc	ASTM D 792
Hardness, Shore D	84	-	ASTM D 2240
Hazem-Williams Factor	C = 150		
MECHANICAL			
Tensile Strength @73°F (22°C)	7,260	psi	ASTM D 638
Tensile Modulus of Elasticity @73°F (22°C)	392,000	psi	ASTM D 638
Flexural Strength @75°F (24°C)	12,000	psi	ASTM D 790
Flexural Modulus of Elasticity @75°F (24°C)	389,000	psi	ASTM D 790
Compressive Strength @75°F (24°C)	8,300	psi	ASTM D 695
Compressive Modulus of Elasticity @75°F (24°C)	307,000	psi	ASTM D 695
Notched Izod Impact - .125" Injection Molded	23	ft-lbs./in.	ASTM D 256
Izod Impact Notched — Method A, with Grain-Comp. Molded, 0.125 in. bars @73°F (22°C)	8.0	ft-lbs./in.	ASTM D256
Izod Impact Notched — Method A, against Grain-Comp. Molded 0.125 in. bars @73°F (22°C)	2.0	ft-lbs./in.	ASTM D256
THERMAL			
Coefficient of Linear Expansion	$4.1 \times 10^{-5}$	in/in °F	ASTM D 696
Heat Distortion Temperature	154	°F	ASTM D 648
Glass Transition Temperature	176°F	°F	-
FIRE PERFORMANCE			
Flammability Rating	V-0	-	UL-94

## Thermal expansion and contraction

As the nature of thermoplastic products, thermal expansion and contraction should be taken into consideration while designing and installing the system. The coefficient of liner expansion for LD's clear PVC pipe is  $4.1 \times 10^{-5}$  in./in./°F. The rate of expansion or contraction can be calculated as follows:

$\Delta L = 12yL(\Delta T)$  Where:

$\Delta L$  = expansion or contraction in inches

$y = 4.1 \times 10^{-5}$  (coefficient of linear expansion)

$L$  = length of piping run in feet

$T$  = temperature change °F (T max. - T @ installation)









## Properties of PVC & CPVC PIPE







ITEM	inch-lb unit			Test Method
	PVC	CPVC	unit	
<b>GENERAL</b>				
Cell Classification	12454	23447	—	ASTM D1784
Maximum Usable Temp.	140	200	°F	—
Specific Gravity @ 73°F(23°C)	1.42±0.02	1.55±0.02	g/cc	ASTM D792
Water Absorption % increase 24 hrs@ 73°F(23°C)	0.04	0.04	%	ASTM D570
Hardness, Rockwell	110 - 120	115 - 125	—	ASTM D785
Poisson's Ratio @ 73°F(23°C)	0.38	0.36	—	ASTM D638
<b>MECHANICAL</b>				
Tensile Strength @ 73°F(23°C)	7,100	7,700	psi	ASTM D638
Tensile Strength @ 194°F(90°C)	—	3,200	psi	"
Tensile Modulus of Elasticity @ 73°F(23°C)	410,000	380,000	psi	"
Tensile Modulus of Elasticity @ 194°F(90°C)	—	220,000	psi	"
Flexural Strength @73°F(23°C)	14,000	13,000	psi	ASTM D790
Flexural Modulus of Elasticity @ 73°F(23°C)	400,000	390,000	psi	"
Compressive Strength @ 73°F(23°C) ε = 10%	10,000	14,000	psi	ASTM D695
Compressive Modulus of Elasticity @ 73°F	110,000	145,000	psi	"
Izod Impact, notched @ 73°F(23°C)	1.5	3.0	ft-lb/in	ASTM D256
<b>THERMAL</b>				
Coefficient of Linear Expansion	2.5-3.5x10 <sup>-5</sup>	3.0-4.0x10 <sup>-5</sup>	in/in/°F	ASTM D696
Coefficient of Thermal Conductivity	1.20	0.90	Btu/in/hr/ft <sup>2</sup> /°F	ASTM C177
Heat Deflection Temperature Under Load (264psi, annealed)	165	230	°F	ASTM D648
Specific Heat	0.27	0.26	Cal./°C/g	ASTM D2766
<b>ELECTRICAL</b>				
Volume Resistivity	>1.0 x 10 <sup>15</sup>	>1.0 x 10 <sup>15</sup>	ohm/cm	ASTM D257
Dielectric Strength	>1000	>1000	volt/mm	ASTM D149
Dielectric Constant	3	3	—	ASTM D150
Power Factor	0.01-0.02	0.01-0.02	—	"
Electrical Conductivity	Non Conductor	Non Conductor	—	"
<b>FIRE PERFORMANCE</b>				
Flammability Rating	_0	V-0 5VB 5VA	—	UL-94
Flame Spread Index	<10	<10	—	"
Average Time of Burning	<5	<5	sec	ASTM D635
Average Extent of Burning	<10	<10	mm	"
Burning Rate	Self Extinguishing	Self Extinguishing	mm/min	"
Limiting Oxygen Index (LOI)	45	60	LOI	ASTM D2863

## Recommended Pipe Hangers for PVC and CPVC Piping Systems

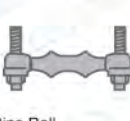

### PIPE RINGS

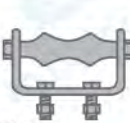
 Adj. Swivel Ring Split Ring Type Fig. 1 2/4 to 8 in. pipe	 Split Ring Fig. 2 3/6 to 8 in. pipe
 Adj. Ring Fig. 6 1/2 to 8 in. pipe	 Adj. Swivel Ring Fig. 7 1/2 to 8 in. pipe
 Adj. Clevis-Standard Fig. 11 1/2 to 30 in. pipe	 Adj. Clevis For Insulated Lines Fig. 12 3/4 to 8 in. pipe



### PIPE ROLLS

 Adj. Steel Yoke Pipe Roll Fig. 3 2 1/2 to 20 in. pipe	 Adj. Swivel Pipe Roll Fig. 4 2 1/2 to 12 in. pipe
 Single Pipe Roll Fig. 8 1 to 30 in. pipe	 Adj. Pipe Roll Support Fig. 9 1 to 30 in. pipe
 Roller Chair Fig. 13 2 to 12 in. pipe	 Roller Chair Fig. 14 2 to 12 in. pipe
 Pipe Roll Stand Complete Fig. 16 2 to 42 in. pipe	

### STRAPS/HOOKS

 Wrought Strap Short Fig. 5 1/2 to 4 in. pipe
 One Hole Clamp Fig. 10 3/6 to 4 in. pipe
 Tin Strap Fig. 15 1/2 to 2 in. pipe

### PIPE RINGS

 Pipe Clamp Medium Fig. 17 1/2 to 24 in. pipe	 Double Bolt Pipe Clamp Fig. 18 2/4 to 36 in. pipe
---	--

### PIPE COVERING

 Insulation Protection Shield Fig. 19 1/2 to 24 in. pipe
--

### Not Recommend BOLT

 U Bolt Fig. 20 Standard 1/2 to 30 in. pipe Light weight 1/2 to 10 in. pipe
---

**NOTE:** Hanger and support spacing of LD PVC & CPVC piping varies depending on pipe diameter and water temperature.

Local regulations usually indicate minimum spacing. Use only smooth straps or hangers that do not place rough or sharp edges against the pipe. Vertical runs must be properly supported to prevent excessive loading on the lower fitting. Clamps and hangers must not compress, distort, cut, abrade or exert compressive stresses on the pipe, otherwise it could result in cracking or premature burst failure.



## INDUSTRIAL ASTM & DIN - PVC/CPVC FITTING

LD Thermoplastic Fittings are Manufactured by the Following Standard Specifications

TYPE		MATERIAL STD.	DIMENSIONS	COMMERCIAL CLASSIFICATION
PVC	Socket-type	ASTM D 1784	ASTM D 2467 DIN 8063	Type I, Grade 1, PVC 12454
	Thread-type		ASTM D 2464 DIN 2999	
CPVC	Socket-type	ASTM D 1784	ASTM F 439 DIN 8063	Type IV, Grade 1, CPVC 23447
	Thread-type		ASTM F 437 DIN 2999	

### Properties of PVC & CPVC Fitting

ITEM	inch-lb unit			Test Method
	PVC	CPVC	unit	
<b>GENERAL</b>				
Cell Classification	12454	23447	-	ASTM D1784
Maximum Usable Temp.	140	200	°F	-
Specific Gravity @ 73°F 23°C	1.42±0.02	1.55±0.02	g/cc	ASTM D792
Water Absorption % increase 24 hrs@ 73°F 23°C	0.04	0.04	%	ASTM D570
Hardness, Rockwell	110 - 120	115 - 125	-	ASTM D785
Poisson's Ratio @ 73°F 23°C	0.38	0.36	-	ASTM D638
<b>MECHANICAL</b>				
Tensile Strength @ 73°F 23°C	7,700	7,700	psi	ASTM D638
Tensile Strength @ 194°F 90°C	-	3,200	psi	"
Tensile Modulus of Elasticity @ 73°F 23°C	420,000	380,000	psi	"
Tensile Modulus of Elasticity @ 194°F 90°C	-	220,000	psi	"
Flexural Strength @73°F 23°C	13,000	13,000	psi	ASTM D790
Flexural Modulus of Elasticity @ 73°F 23°C	420,000	390,000	psi	"
Compressive Strength @ 73°F 23°C = 10	10,000	14,000	psi	ASTM D695
Compressive Modulus of Elasticity @ 73°F	110,000	145,000	psi	"
Izod Impact, notched @ 73°F 23°C	1.0	3.0	ft-lb/in	ASTM D256
<b>THERMAL</b>				
Coefficient of Linear Expansion	2.5-3.5x10 <sup>-5</sup>	3.0-4.0x10 <sup>-5</sup>	in/in/°F	ASTM D696
Coefficient of Thermal Conductivity	1.11	0.90	Btu/in/hr/ft.2°F	ASTM C177
Heat Deflection Temperature Under Load (264psi, annealed)	170	230	°F	ASTM D648
Specific Heat	0.27	0.26	Cal./°C/g	ASTM D2766
<b>ELECTRICAL</b>				
Volume Resistivity	>1.0 x 10 <sup>15</sup>	>1.0 x 10 <sup>15</sup>	ohm/cm	ASTM D257
Dielectric Strength	>1000	>1000	volt/mm	ASTM D149
Dielectric Constant	3	3	-	ASTM D150
Power Factor	0.01-0.02	0.01-0.02	-	"
Electrical Conductivity	Non Conductor	Non Conductor	-	-
<b>FIRE PERFORMANCE</b>				
Flammability Rating	V-0	V-0,5VB,5VA	-	UL-94
Flame Spread Index	<10	<10	-	"
Average Time of Burning	<5	<5	sec	ASTM D635
Average Extent of Burning	<10	<10	mm	"
Burning Rate	Self Extinguishing	Self Extinguishing	mm/min	"
Limiting Oxygen Index (LOI)	45	60	LOI	ASTM D2863



## Socket Dimensions

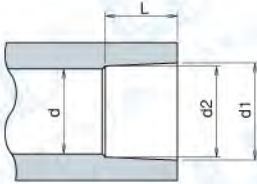

PVC / CPVC SCHEDULE 80  
TAPER SOCKET DIMENSIONS  
(SOLVENT CEMENT STYLE)  
ASTM D 2467 (PVC)  
ASTM F 439 (CPVC)

## ASTM D 2467, F 439

Nominal Pipe Size	Inside Diameter min. d	Socket Entrance Diameter d1		Socket Bottom Diameter d2		Minimum Socket Depth L
		Inch	mm	Inch	mm	
1/2"	0.63	0.85	±0.004	0.84	±0.004	0.88
3/4"	0.87	1.06	±0.004	1.05	±0.004	1.00
1"	1.06	1.33	±0.005	1.31	±0.005	1.13
1-1/4"	1.46	1.67	±0.005	1.66	±0.005	1.25
1-1/2"	1.65	1.91	±0.006	1.89	±0.006	1.38
2"	2.13	2.39	±0.006	2.37	±0.006	1.50
2-1/2"	2.60	2.89	±0.007	2.87	±0.007	1.75
3"	3.23	3.52	±0.008	3.49	±0.008	1.88
4"	4.09	4.02	±0.009	4.49	±0.009	2.25
5"	5.20	5.58	±0.010	5.55	±0.010	2.64
6"	6.14	6.65	±0.011	6.61	±0.011	3.03
8"	8.27	8.66	±0.015	8.61	±0.015	4.02
10"	10.43	10.78	±0.015	10.74	±0.015	5.51
12"	12.40	12.78	±0.015	12.74	±0.015	6.10
14"	12.41	14.04	±0.015	13.99	±0.015	9.00
16"	14.21	16.05	±0.015	15.98	±0.015	10.00

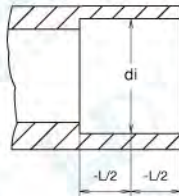

PVC / CPVC TAPER  
SOCKET DIMENSIONS  
(SOLVENT CEMENT STYLE)  
DIN 8063 (PVC/CPVC)

## DIN 8063

Socket Diameter dn	Mean Inside Diameter		Out-of-roundness	Minimum Socket Depth L
	mm	mm		
20	20.1	20.3	0.25	16.1
25	25.1	25.3	0.25	18.6
32	32.1	32.3	0.25	22.1
40	40.1	40.3	0.25	26.1
50	50.1	50.3	0.30	31.1
63	63.1	63.3	0.40	37.6
75	75.1	75.3	0.50	43.6
90	90.1	90.3	0.60	51.1
110	110.1	110.4	0.70	61.1
125	125.1	125.4	0.80	68.6
140	140.2	140.5	0.90	76.1
160	160.2	160.5	1.00	86.1
180	180.2	180.6	1.10	96.1
200	200.2	200.6	1.20	106.1
225	225.3	225.7	1.40	118.7
250	250.3	250.8	1.50	131.2
280	280.3	280.9	1.70	146.2
315	315.4	316.0	1.90	163.7
355	355.4	356.1	2.00	183.7
400	400.4	401.2	2.00	206.2

Note: 1. The mean inside diameter of socket shall be taken to be the arithmetic mean of two measurements taken at right angles to each other at the mid-point of the socket.  
2. The maximum included angle of the socketed portion shall not exceed 0.5°.

## Thread Dimensions

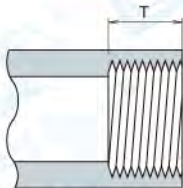

FEMALE TAPER THREADS  
ASTM D 2464 (PVC)  
ASTM F 437 (CPVC)  
ASTM F 1496



MALE TAPER THREADS  
ASTM D 2464 (PVC)  
ASTM F 437 (CPVC)  
ASTM F 1496

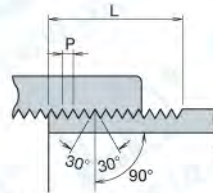

AMERICAN NATIONAL STANDARD  
TAPER PIPE THREADS (NPT)  
ASME (ANSI) B1.20.1  
ASTM F 1498

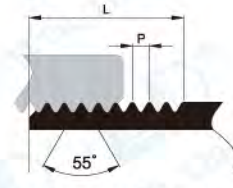

BRITISH STANDARD  
TAPER PIPE THREAD (BSPT)  
DIN 2999 (PVC/CPVC)

### NPT

Nominal Pipe Size	Female Thread Min. Length T		Male Thread Min. Length S		Overall Pipe Thread Length L		Pitch of Thread P	Threads Per In.	Height of Thread		
	Inch	mm	Inch	mm	Inch	mm			Inch	mm	
1/2"	0.91	23	0.73	18.5	0.78	19.9	0.07	1.8	14	0.06	1.45
3/4"	1.02	26	0.73	18.5	0.79	20.2	0.07	1.8	14	0.06	1.45
1"	1.14	29	0.83	21	0.99	25.0	0.09	2.2	11-1/2	0.07	1.77
1-1/4"	1.26	32	0.96	24.5	1.01	25.6	0.09	2.2	11-1/2	0.07	1.77
1-1/2"	1.38	35	0.96	24.5	1.03	26.0	0.09	2.2	11-1/2	0.07	1.77
2"	1.57	40	1.06	27	1.06	26.9	0.13	2.2	11-1/2	0.07	1.77
2-1/2"	1.77	45	1.57	40	1.57	39.9	0.13	3.2	8	0.10	2.54
3"	1.89	48	1.65	42	1.63	41.5	0.13	3.2	8	0.10	2.54
4"	2.28	58	1.75	44.5	1.73	44.0	0.13	3.2	8	0.10	2.54

### BSPT

Nominal Pipe Size	Effective Thread Length L	Pitch of Thread P	Threads Per In.
1/2"	13.2	1.81	14
3/4"	14.5	1.81	14
1"	16.7	2.31	11
1-1/4"	19.1	2.31	11
1-1/2"	19.1	2.31	11
2"	23.4	2.31	11
2-1/2"	26.7	2.31	11
3"	29.9	2.31	11
4"	35.8	2.31	11



## LD-501 90° Elbow Codo 90°

Socket  
Encolar

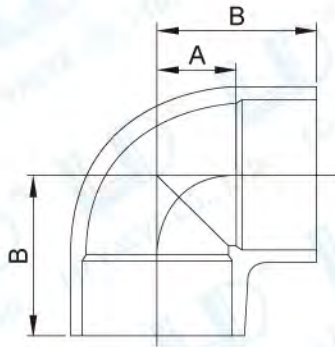

Unit / mm-kg

ASTM Inch	DIN d(mm)	mm		Weight (kg/pc)				Pcs/Ctn
		A	B	Part Number	PVC	Part Number	CPVC	
1/2"	20	15.3	37.5	501-012	0.04	501-012C	0.04	50
3/4"	25	17.1	42.5	501-034	0.05	501-034C	0.05	30
1"	32	21.4	50.0	501-100	0.08	501-100C	0.09	40
1-1/4"	40	26.2	58.0	501-114	0.14	501-114C	0.15	20
1-1/2"	50	30.1	65.0	501-112	0.19	501-112C	0.20	24
2"	63	35.9	74.0	501-200	0.27	501-200C	0.29	12
2-1/2"	75	44.6	89.0	501-212	0.46	501-212C	0.50	8
3"	90	53.4	101	501-300	0.77	501-300C	0.84	5
4"	110	63.9	121	501-400	1.24	501-400C	1.35	8
6"	160	95.0	173	501-600	3.52	501-600C	3.85	4
8"	200/225	122	225	501-800	7.12	501-800C	7.77	2
10"	250/280	150	290	501-1000	10.6	501-1000C	11.6	1
12"	315	175	330	501-1200	18.1	501-1200C	19.8	1
14"	355	197	427	501-1400	26.1	501-1400C	27.41	1
16"	400	235.4	492	501-1600	40.9	501-1600C	42.95	1

## LD-502 90° Elbow Codo 90°

Socket X Female Thread  
Encolar X Rosca Hembra

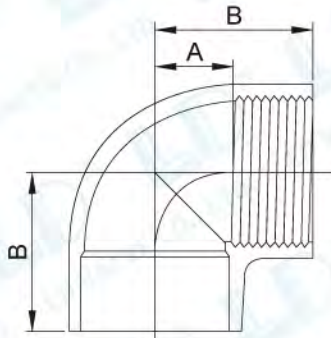

Unit / mm-kg

ASTM Inch	DIN d(mm)	mm		Weight (kg/pc)				Pcs/Ctn
		A	B	Part Number	PVC	Part Number	CPVC	
1/2"	20	15.3	37.5	502-012	0.04	502-012C	0.04	50
3/4"	25	17.1	42.5	502-034	0.05	502-034C	0.05	30
1"	32	21.4	50.0	502-100	0.09	502-100C	0.09	40
1-1/4"	40	26.2	58.0	502-114	0.15	502-114C	0.16	20
1-1/2"	50	30.1	65.0	502-112	0.20	502-112C	0.21	24
2"	63	35.9	74.0	502-200	0.28	502-200C	0.31	12
2-1/2"	75	44.6	89.0	502-212	0.49	502-212C	0.53	8
3"	90	53.4	101	502-300	0.81	502-300C	0.88	5
4"	110	63.9	121	502-400	1.30	502-400C	1.42	8

## LD-503 90° Elbow Codo 90°

Female Thread  
Rosca Hembra

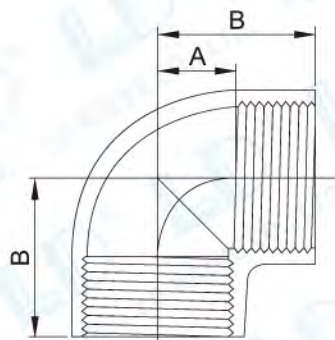

Unit / mm-kg

ASTM Inch	DIN d(mm)	mm		Weight (kg/pc)				Pcs/Ctn
		A	B	Part Number	PVC	Part Number	CPVC	
1/2"	20	15.3	37.5	503-012	0.04	503-012C	0.05	50
3/4"	25	17.1	42.5	503-034	0.05	503-034C	0.06	30
1"	32	21.4	50.0	503-100	0.09	503-100C	0.10	40
1-1/4"	40	26.2	58.0	503-114	0.16	503-114C	0.17	20
1-1/2"	50	30.1	65.0	503-112	0.21	503-112C	0.22	24
2"	63	35.9	74.0	503-200	0.30	503-200C	0.33	12
2-1/2"	75	44.6	89.0	503-212	0.51	503-212C	0.56	8
3"	90	53.4	101	503-300	0.85	503-300C	0.93	5
4"	110	63.9	121	503-400	1.37	503-400C	1.49	8



## LD-511 45° Elbow Codo 45°

Socket  
Encolar

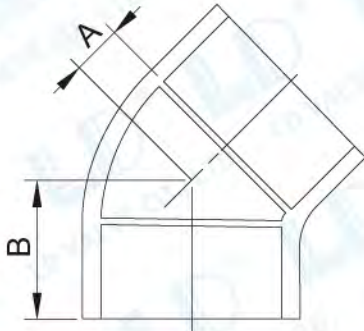

Unit / mm-kg

ASTM Inch	DIN d(mm)	mm		Weight (kg/pc)				Pcs/Ctn
		A	B	Part Number	PVC	Part Number	CPVC	
1/2"	20	6.78	29.0	511-012	0.03	511-012C	0.03	70
3/4"	25	8.61	34.0	511-034	0.04	511-034C	0.05	40
1"	32	8.41	37.0	511-100	0.06	511-100C	0.07	40
1-1/4"	40	11.3	43.0	511-114	0.10	511-114C	0.11	30
1-1/2"	50	12.1	47.0	511-112	0.13	511-112C	0.14	32
2"	63	16.9	55.0	511-200	0.19	511-200C	0.21	18
2-1/2"	75	19.6	64.0	511-212	0.36	511-212C	0.39	10
3"	90	24.4	72.0	511-300	0.58	511-300C	0.63	10
4"	110	28.9	86.0	511-400	0.91	511-400C	1.00	8
6"	160	46.0	124	511-600	2.58	511-600C	2.81	2
8"	200/225	55.0	158	511-800	4.92	511-800C	5.37	2
10"	250/280	70.0	210	511-1000	7.43	511-1000C	8.30	1
12"	315	85.0	240	511-1200	15.3	511-1200C	16.7	1
14"	355	101	329	511-1400	21.1	511-1400C	23.18	1
16"	400	107	360	511-1600	28.73	511-1600C	32.18	1

## LD-512 45° Elbow Codo 45°

Socket X Female Thread  
Encolar X Female Thread

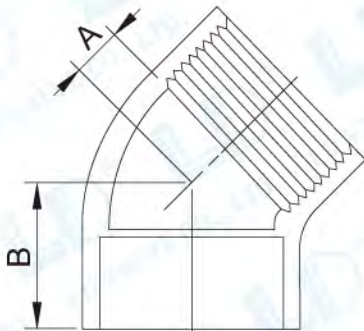

Unit / mm-kg

ASTM Inch	DIN d(mm)	mm		Weight (kg/pc)				Pcs/Ctn
		A	B	Part Number	PVC	Part Number	CPVC	
1/2"	20	6.78	29.0	512-012	0.03	512-012C	0.03	70
3/4"	25	8.61	34.0	512-034	0.04	512-034C	0.05	40
1"	32	8.41	37.0	512-100	0.07	512-100C	0.07	40
1-1/4"	40	11.3	43.0	512-114	0.10	512-114C	0.12	30
1-1/2"	50	12.1	47.0	512-112	0.14	512-112C	0.15	32
2"	63	16.9	55.0	512-200	0.20	512-200C	0.22	18
2-1/2"	75	19.6	64.0	512-212	0.38	512-212C	0.41	10
3"	90	24.4	72.0	512-300	0.61	512-300C	0.66	10
4"	110	28.9	86.0	512-400	0.96	512-400C	1.05	8

## LD-513 45° Elbow Codo 45°

Female Thread  
Rosca Hembra

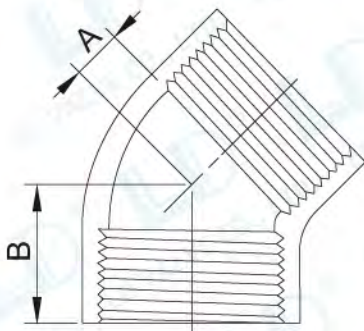

Unit / mm-kg

ASTM Inch	DIN d(mm)	mm		Weight (kg/pc)				Pcs/Ctn
		A	B	Part Number	PVC	Part Number	CPVC	
1/2"	20	6.78	29.0	513-012	0.04	513-012C	0.04	70
3/4"	25	8.61	34.0	513-034	0.05	513-034C	0.05	40
1"	32	8.41	37.0	513-100	0.07	513-100C	0.08	40
1-1/4"	40	11.3	43.0	513-114	0.11	513-114C	0.13	30
1-1/2"	50	12.1	47.0	513-112	0.15	513-112C	0.16	32
2"	63	16.9	55.0	513-200	0.21	513-200C	0.23	18
2-1/2"	75	19.6	64.0	513-212	0.40	513-212C	0.43	10
3"	90	24.4	72.0	513-300	0.64	513-300C	0.70	10
4"	110	28.9	86.0	513-400	1.01	513-400C	1.10	8



## LD-521 Tee

Te  
Socket Encolar

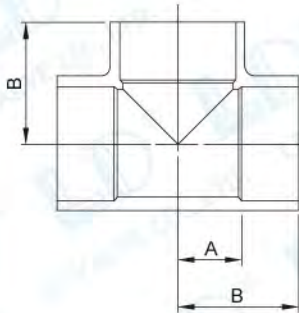

ASTM Inch	DIN d(mm)	mm		Part Number	Weight (kg/pc)			Pcs/Ctn
		A	B		PVC	Part Number	CPVC	
1/2"	20	15.3	37.5	521-012	0.05	521-012C	0.05	40
3/4"	25	17.1	42.5	521-034	0.06	521-034C	0.07	24
1"	32	21.4	50.0	521-100	0.10	521-100C	0.11	24
1-1/4"	40	26.2	58.0	521-114	0.19	521-114C	0.20	15
1-1/2"	50	30.1	65.0	521-112	0.24	521-112C	0.25	16
2"	63	35.9	74.0	521-200	0.35	521-200C	0.39	10
2-1/2"	75	44.6	89.0	521-212	0.62	521-212C	0.68	10
3"	90	53.4	101	521-300	1.01	521-300C	1.10	5
4"	110	63.9	121	521-400	1.58	521-400C	1.72	8
6"	160	95.0	173	521-600	4.32	521-600C	4.71	2
8"	200/225	122	225	521-800	8.96	521-800C	9.78	1
10"	250/280	150	290	521-1000	15.2	521-1000C	16.61	1
12"	315	186.8	330	521-1200	23.0	521-1200C	24.1	1
14"	355	197.8	426.6	521-1400	35.9	521-1400C	38.0	1
16"	400	236.2	492.0	521-1600	54.6	521-1600C	57.33	1

Unit / mm-kg

## LD-522 Tee

Te  
Socket X Female Thread X Socket  
Encolar X Rosca Hembra X Encolar

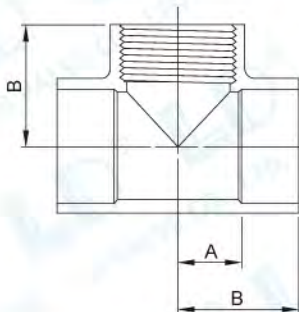

ASTM Inch	DIN d(mm)	mm		Part Number	Weight (kg/pc)			Pcs/Ctn
		A	B		PVC	Part Number	CPVC	
1/2"	20	15.3	37.5	522-012	0.05	522-012C	0.06	40
3/4"	25	17.1	42.5	522-034	0.07	522-034C	0.08	24
1"	32	21.4	50.0	522-100	0.11	522-100C	0.12	24
1-1/4"	40	26.2	58.0	522-114	0.20	522-114C	0.21	15
1-1/2"	50	30.1	65.0	522-112	0.25	522-112C	0.27	16
2"	63	35.9	74.0	522-200	0.37	522-200C	0.40	10
2-1/2"	75	44.6	89.0	522-212	0.65	522-212C	0.71	10
3"	90	53.4	101	522-300	1.06	522-300C	1.16	5
4"	110	63.9	121	522-400	1.66	522-400C	1.81	8

Unit / mm-kg

## LD-523 Tee

Te  
Female Thread  
Rosca Hembra

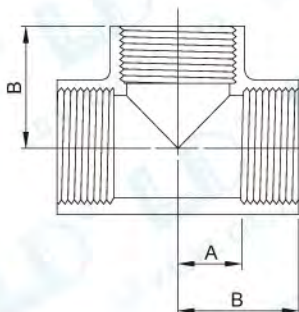

ASTM Inch	DIN d(mm)	mm		Part Number	Weight (kg/pc)			Pcs/Ctn
		A	B		PVC	Part Number	CPVC	
1/2"	20	15.3	37.5	523-012	0.06	523-012C	0.06	40
3/4"	25	17.1	42.5	523-034	0.07	523-034C	0.08	24
1"	32	21.4	50.0	523-100	0.12	523-100C	0.13	24
1-1/4"	40	26.2	58.0	523-114	0.21	523-114C	0.22	15
1-1/2"	50	30.1	65.0	523-112	0.26	523-112C	0.28	16
2"	63	35.9	74.0	523-200	0.39	523-200C	0.43	10
2-1/2"	75	44.6	89.0	523-212	0.68	523-212C	0.75	10
3"	90	53.4	101	523-300	1.11	523-300C	1.22	5
4"	110	63.9	121	523-400	1.74	523-400C	1.90	8

Unit / mm-kg



## LD-526 Reducing Tee Te Reducido

Socket  
Encolar

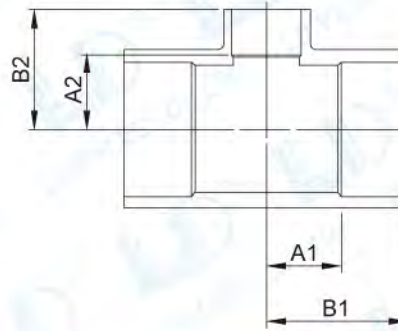

Unit / mm-kg

ASTM Inch	DIN d x d1(mm)	mm				Weight (kg/pc)			Pcs/Ctn	
		A1	A2	B1	B2	Part Number PVC	Part Number CPVC	CPVC		
3/4" x 1/2"	25 x 20	17.1	17.5	42.5	40.0	526-034C	0.06	526-034CC	0.07	30
1" x 1/2"	32 x 20	21.4	21.5	50.0	44.0	526-100C	0.10	526-100CC	0.11	30
1" x 3/4"	32 x 25	21.4	21.5	50.0	46.0	526-100D	0.10	526-100CD	0.11	30
1-1/4" x 1/2"	40 x 20	26.2	26.5	58.0	48.0	526-114C	0.15	526-114CC	0.17	20
1-1/4" x 3/4"	40 x 25	26.2	26.5	58.0	52.0	526-114D	0.15	526-114CD	0.17	20
1-1/4" x 1"	40 x 32	26.2	26.5	58.0	56.0	526-114E	0.16	526-114CE	0.18	15
1-1/2" x 1/2"	50 x 20	30.1	30.0	65.0	52.0	526-112C	0.20	526-112CC	0.22	10
1-1/2" x 3/4"	50 x 25	30.1	30.0	65.0	55.0	526-112D	0.20	526-112CD	0.23	10
1-1/2" x 1"	50 x 32	30.1	30.0	65.0	58.0	526-112E	0.21	526-112CE	0.23	10
1-1/2" x 1-1/4"	50 x 40	30.1	30.0	65.0	62.0	526-112F	0.22	526-112CF	0.24	10
2" x 1/2"	63 x 20	35.9	36.5	74.0	58.0	526-200C	0.28	526-200CC	0.31	10
2" x 3/4"	63 x 25	35.9	36.5	74.0	61.0	526-200D	0.28	526-200CD	0.32	10
2" x 1"	63 x 32	35.9	36.5	74.0	65.0	526-200E	0.29	526-200CE	0.33	10
2" x 1-1/4"	63 x 40	35.9	36.5	74.0	68.0	526-200F	0.30	526-200CF	0.34	10
2" x 1-1/2"	63 x 50	35.9	36.5	74.0	72.0	526-200G	0.31	526-200CG	0.35	10
2-1/2" x 1-1/2"	75 x 50	44.6	44.0	89.0	77.0	526-212G	0.54	526-212CG	0.59	10
2-1/2" x 2"	75 x 63	44.6	44.0	89.0	82.0	526-212H	0.55	526-212CH	0.62	10
3" x 1-1/2"	90 x 50	53.4	53.5	101	85.0	526-300G	0.71	526-300CG	0.79	5
3" x 2"	90 x 63	53.4	53.5	101	90.0	526-300H	0.73	526-300CH	0.82	5
3" x 2-1/2"	90 x 75	53.4	53.5	101	97.0	526-300I	0.77	526-300CI	0.86	5
4" x 2"	110 x 63	63.8	66.5	121	101	526-400H	1.32	526-400CH	1.48	5
4" x 2-1/2"	110 x 75	63.9	66.5	121	108	526-400I	1.32	526-400CI	1.48	5
4" x 3"	110 x 90	63.9	66.5	121	112	526-400J	1.38	526-400CJ	1.54	5
6" x 3"	160 x 90	95.0	96.0	173	143	526-600J	3.34	526-600CJ	3.73	4
6" x 4"	160 x 110	95.0	96.0	173	153	526-600L	3.32	526-600CL	3.71	4
8" x 3"	200 225 x 90	122	123.5	225	170	526-800J	7.70	526-800CJ	8.60	2
8" x 4"	200 225 x 110	122	123.5	225	180	526-800L	7.84	526-800CL	8.76	2
8" x 6"	200 225 x 160	122	123.5	225	201	526-800P	8.10	526-800CP	9.05	2
10" x 4"	250 280 x 110	150	153.5	290	211	526-1000L	13.98	526-1000CL	15.62	1
10" x 8"	200 225 x 250 280	150	153.5	290	261	526-1000S	14.12	526-1000CS	15.77	1
12" x 4"	315 x 110	175	181.5	330	240.5	526-1200L	21.85	526-1200CL	24.41	1
12" x 8"	315 x 200 225	175	181.5	330	286	526-1200S	21.55	526-1200CS	24.08	1
12" x 10"	315 x 250 280	175	181.5	330	331.2	526-1200T	21.36	526-1200CT	23.85	1
14" x 12"	355 x 315	198	197	427	360	526-1400U	21.40	526-1400CU	23.90	1
16" x 12"	400 x 315	238	226	492	418	526-1600U	49.0	526-1600CU	51.50	1
16" x 14"	400 x 355	238	226	492	492	526-1600V	50.1	526-1600CV	52.60	1

### Combination Chart of Tee

#: Tee without Bushing #B: Tee with one Bushing #BB: Tee with 2 pieces of Bushing

		Tee Branch Size															
		1/2"	3/4"	1"	1-1/4"	1-1/2"	2"	2-1/2"	3"	4"	5"	6"	8"	10"	12"	14"	16"
Tee Body Size	1/2"	#															
	3/4"	#	#														
	1"	#	#	#													
	1-1/4"	#	#	#	#												
	1-1/2"	#	#	#	#	#											
	2"	#	#	#	#	#	#										
	2-1/2"	#B	#B	#B	#B	#	#	#									
	3"	#B	#B	#B	#B	#	#	#	#								
	4"	#B	#B	#B	#B	#B	#	#	#	#							
	5"	#BB	#BB	#B	#B	#B	#B	#B	#B	#	#						
	6"	#BB	#BB	#B	#B	#B	#B	#B	#B	#	#	#					
	8"	#BB	#BB	#B	#B	#B	#B	#B	#B	#	#	#B	#	#			
	10"	#BB	#BB	#B	#B	#B	#B	#B	#B	#	#BB	#B	#	#			
	12"	#BB	#BB	#B	#B	#B	#B	#B	#B	#	#BB	#B	#	#	#		
	14"								#BB	#BB	#BB	#B	#B	#	#	#	
	16"								#BB	#BB	#BB	#B	#B	#B	#	#	



## LD-527 Reducing Tee Te Reducido

Socket X Female Thread X Socket  
Encolar X Rosca Hembra X Encolar

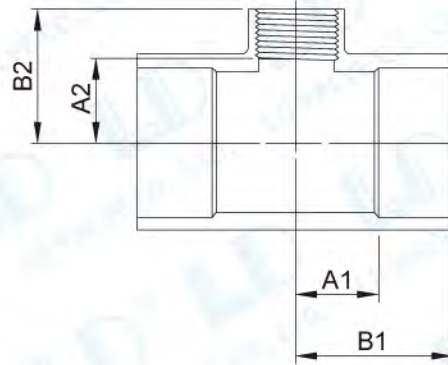

Unit / mm-kg

ASTM Inch	DIN d x d1(mm)	mm				Weight (kg/pc)				Pcs/Ctn
		A1	A2	B1	B2	Part Number	PVC	Part Number	CPVC	
3/4" x 1/2"	25 x 20	17.1	17.8	42.5	40.0	527-034C	0.07	527-034CC	0.08	30
1" x 1/2"	32 x 20	21.4	21.8	50.0	44.0	527-100C	0.10	527-100CC	0.11	30
1" x 3/4"	32 x 25	21.4	38.6	50.0	46.0	527-100D	0.11	527-100CD	0.12	30
1-1/4" x 1/2"	40 x 20	26.2	25.8	58.0	48.0	527-114C	0.16	527-114CC	0.18	20
1-1/4" x 3/4"	40 x 25	26.2	26.6	58.0	52.0	527-114D	0.17	527-114CD	0.19	20
1-1/4" x 1"	40 x 32	26.2	27.4	58.0	56.0	527-114E	0.18	527-114CE	0.20	15
1-1/2" x 1/2"	50 x 20	30.1	29.8	65.0	52.0	527-112C	0.21	527-112CC	0.23	10
1-1/2" x 3/4"	50 x 25	30.1	29.6	65.0	55.0	527-112D	0.21	527-112CD	0.24	10
1-1/2" x 1"	50 x 32	30.1	29.4	65.0	58.0	527-112E	0.23	527-112CE	0.25	10
1-1/2" x 1-1/4"	50 x 40	30.1	30.3	65.0	62.0	527-112F	0.24	527-112CF	0.27	10
2" x 1/2"	63 x 20	35.9	35.8	74.0	58.0	527-200C	0.29	527-200CC	0.32	10
2" x 3/4"	63 x 25	35.9	35.6	74.0	61.0	527-200D	0.29	527-200CD	0.33	10
2" x 1"	63 x 32	35.9	36.4	74.0	65.0	527-200E	0.31	527-200CE	0.35	10
2" x 1-1/4"	63 x 40	35.9	36.2	74.0	68.0	527-200F	0.33	527-200CF	0.37	10
2" x 1-1/2"	63 x 50	35.9	37.1	74.0	72.0	527-200G	0.35	527-200CG	0.39	10
2-1/2" x 1-1/2"	75 x 50	44.6	42.1	89.0	77.0	527-212G	0.57	527-212CG	0.64	10
2-1/2" x 2"	75 x 63	44.6	43.9	89.0	82.0	527-212H	0.61	527-212CH	0.68	10
3" x 1-1/2"	90 x 50	53.4	50.1	101	85.0	527-300G	0.75	527-300CG	0.84	5
3" x 2"	90 x 63	53.4	51.9	101	90.0	527-300H	0.79	527-300CH	0.88	5
3" x 2-1/2"	90 x 75	53.4	52.6	101	97.0	527-300I	0.87	527-300CI	0.97	5
4" x 2"	110 x 63	63.9	62.9	121	101	527-400H	1.38	527-400CH	1.55	5
4" x 2-1/2"	110 x 75	63.9	63.6	121	108	527-400I	1.43	527-400CI	1.59	5
4" x 3"	110 x 90	63.9	64.4	121	112	527-400J	1.52	527-400CJ	1.70	5
6" x 3"	160 x 90	95.0	95.4	173	143	527-600J	3.48	527-600CJ	3.89	4
6" x 4"	160 x 110	95.0	95.9	173	153	527-600L	3.57	527-600CL	3.99	4
8" x 3"	200 225 x 90	122	122	225	170	527-800J	7.85	527-800CJ	8.76	2
8" x 4"	200 225 x 110	122	123	225	180	527-800L	8.09	527-800CL	9.04	2
10" x 4"	250 280 x 110	150	154	290	211	527-1000L	14.11	527-1000CL	15.76	2
12" x 4"	315 x 110	175	183	330	211	527-1200L	21.48	527-1200CL	24.00	1



## LD-531

### Coupling Manquito Unión

Socket  
Encolar

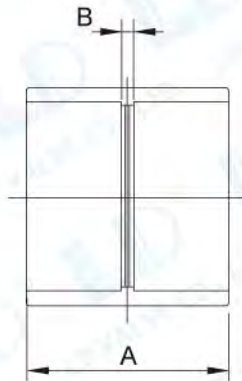

Unit / mm-kg

ASTM Inch	DIN d(mm)	mm		Weight (kg/pc)				Pcs/Ctn
		A	B	Part Number	PVC	Part Number	CPVC	
1/2"	20	50.0	5.59	531-012	0.02	531-012C	0.02	75
3/4"	25	56.0	5.21	531-034	0.03	531-034C	0.03	50
1"	32	63.0	5.84	531-100	0.05	531-100C	0.05	40
1-1/4"	40	69.0	5.51	531-114	0.08	531-114C	0.09	40
1-1/2"	50	75.0	5.13	531-112	0.11	531-112C	0.12	28
2"	63	85.0	8.79	531-200	0.16	531-200C	0.17	30
2-1/2"	75	96.0	7.11	531-212	0.25	531-212C	0.28	24
3"	90	102	6.73	531-300	0.39	531-300C	0.42	12
4"	110	123	8.71	531-400	0.55	531-400C	0.60	18
6"	160	165	8.99	531-600	1.37	531-600C	1.50	4
8"	200/225	216	10.01	531-800	3.08	531-800C	3.30	2
10"	250/280	295	15.01	531-1000	6.17	531-1000C	6.34	1
12"	315	330	19.99	531-1200	9.20	531-1200C	9.70	1
14"	355	480	19.40	531-1400	14.60	531-1400C	15.5	1
16"	400	538	28.0	531-1600	21.59	531-1600C	22.4	1

## LD-536

### Reducing Coupling Manquito Unión Reducido

Socket  
Encolar

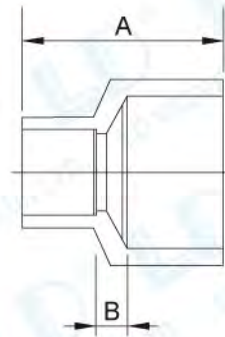

Unit / mm-kg

ASTM Inch	DIN d x d1(mm)	mm		Weight (kg/pc)				Pcs/Ctn
		A	B	Part Number	PVC	Part Number	CPVC	
3/4" x 1/2"	25 x 20	53.6	5.84	536-034C	0.03	536-034CC	0.03	100
1" x 1/2"	32 x 20	59.9	9.40	536-100C	0.04	536-100CC	0.05	75
1" x 3/4"	32 x 25	59.9	5.84	536-100D	0.04	536-100CD	0.04	75
1-1/4" x 1/2"	40 x 20	68.1	14.0	536-114C	0.06	536-114CC	0.07	75
1-1/4" x 3/4"	40 x 25	68.1	10.9	536-114D	0.06	536-114CD	0.07	75
1-1/4" x 1"	40 x 32	68.1	7.62	536-114E	0.07	536-114CE	0.08	75
1-1/2" x 1/2"	50 x 20	74.9	17.8	536-112C	0.08	536-112CC	0.09	50
1-1/2" x 3/4"	50 x 25	74.9	14.7	536-112D	0.08	536-112CD	0.09	50
1-1/2" x 1"	50 x 32	74.9	11.4	536-112E	0.09	536-112CE	0.10	50
1-1/2" x 1-1/4"	50 x 40	74.9	8.38	536-112F	0.10	536-112CF	0.11	50
2" x 1/2"	63 x 20	83.1	22.6	536-200C	0.12	536-200CC	0.13	40
2" x 3/4"	63 x 25	83.1	19.6	536-200D	0.11	536-200CD	0.13	40
2" x 1"	63 x 32	83.1	16.3	536-200E	0.12	536-200CE	0.13	40
2" x 1-1/4"	63 x 40	83.1	13.2	536-200F	0.13	536-200CF	0.15	40
2" x 1-1/2"	63 x 50	83.1	9.91	536-200G	0.14	536-200CG	0.15	40
2-1/2" x 1-1/2"	75 x 50	93.0	13.7	536-212G	0.21	536-212CG	0.22	40
2-1/2" x 2"	75 x 63	93.0	10.4	536-212H	0.22	536-212CH	0.24	40
3" x 1"	90 x 32	106	29.7	536-300E	0.32	536-300CE	0.35	32
3" x 1-1/2"	90 x 50	106	23.4	536-300G	0.31	536-300CG	0.34	32



## LD-536 Reducing Coupling Manquito Unión Reducido

Socket  
Encolar

Unit / mm-kg

ASTM Inch	DIN d x d1(mm)	mm		Part Number	Weight (kg/pc)			Pcs/Ctn
		A	B		PVC	Part Number	CPVC	
3" x 2"	90 x 63	106	15.5	536-300H	0.44	536-300CH	0.48	32
3" x 2-1/2"	90 x 75	106	14.0	536-300I	0.36	536-300CI	0.39	30
4" x 2"	110 x 63	125	29.7	536-400H	0.51	536-400CH	0.55	24
4" x 2-1/2"	110 x 75	125	23.4	536-400I	0.53	536-400CI	0.58	24
4" x 3"	110 x 90	125	20.3	536-400J	0.60	536-400CJ	0.65	24
6" x 3"	160 x 90	168	55.1	536-600J	1.50	536-600CJ	1.64	8
6" x 4"	160 x 110	168	32.8	536-600L	1.41	536-600CL	1.54	8
8" x 4"	200 225 x 110	218	57.9	536-800L	2.75	536-800CL	3.00	4
8" x 6"	200 225 x 160	218	37.1	536-800P	2.95	536-800CP	3.22	4
10" x 8"	250 280 x 225	287	43.9	536-1000S	5.61	536-1000CS	6.12	2
12" x 8"	250 280 x 110	328	70.1	536-1200S	8.20	536-1200CS	8.95	2
12" x 10"	315 x 200 225	328	33.0	536-1200T	8.77	536-1200CT	9.57	2
14" x 12"	355 x 315	425.1	40.0	536-1400U	13.06	536-1400CU	13.08	2
16" x 12"	400 x 315	493.0	88.0	536-1600U	18.40	536-1600CU	19.50	2
16" x 14"	400 x 355	543.2	62.6	536-1600V	25.80	536-1600CV	27.10	2

### Combination Chart of Coupling

#: Coupling without Bushing #B: Coupling with one Bushing #BB: Coupling with 2 pieces of Bushing

		Reducing Size															
		1/2"	3/4"	1"	1-1/4"	1-1/2"	2"	2-1/2"	3"	4"	5"	6"	8"	10"	12"	14"	16"
Inlet Size	1/2"	#															
	3/4"	#	#														
	1"	#	#	#													
	1-1/4"	#	#	#	#												
	1-1/2"	#	#	#	#	#											
	2"	#	#	#	#	#	#										
	2-1/2"	#B	#B	#B	#B	#	#	#									
	3"	#B	#B	#	#B	#	#	#	#								
	4"	#B	#B	#B	#B	#B	#	#	#	#							
	5"	#BB	#BB	#B	#B	#B	#B	#B	#B	#	#						
	6"	#BB	#BB	#B	#B	#B	#B	#B	#B	#	#	#					
	8"	#BB	#BB	#B	#B	#B	#B	#B	#B	#	#B	#	#				
	10"			#BB	#BB	#BB	#BB	#BB	#BB	#B	#BB	#B	#	#			
	12"			#BB	#BB	#BB	#BB	#BB	#BB	#B	#BB	#B	#	#	#		
	14"								#BB	#BB	#BB	#B	#B	#B	#	#	
	16"								#BB	#BB	#BB	#B	#B	#B	#	#	#



**LD-541** Cap  
Tapa  
Socket  
Encolar

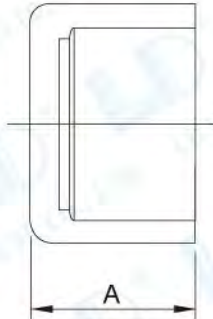

Unit / mm-kg

ASTM Inch	DIN d(mm)	mm A	Weight (kg/pc)				Pcs/Ctn
			Part Number	PVC	Part Number	CPVC	
1/2"	20	30.0	541-012	0.02	541-012C	0.02	100
3/4"	25	34.0	541-034	0.02	541-034C	0.03	75
1"	32	38.0	541-100	0.04	541-100C	0.04	60
1-1/4"	40	42.0	541-114	0.06	541-114C	0.06	50
1-1/2"	50	46.0	541-112	0.09	541-112C	0.10	40
2"	63	52.0	541-200	0.12	541-200C	0.13	30
2-1/2"	75	60.0	541-212	0.20	541-212C	0.22	20
3"	90	65.5	541-300	0.36	541-300C	0.39	15
4"	110	79.6	541-400	0.47	541-400C	0.49	10
6"	160	101	541-600	1.19	541-600C	1.25	8
8"	200/225	132	541-800	2.33	541-800C	2.44	6
10"	250/280	168	541-1000	4.59	541-1000C	4.82	2
12"	315	186	541-1200	7.08	541-1200C	7.43	2

**LD-542** Cap  
Tapa  
Female Thread  
Rosca Hembra

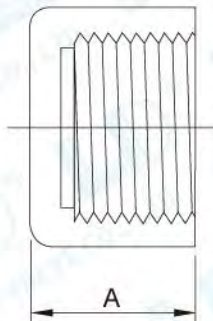

Unit / mm-kg

ASTM Inch	DIN d(mm)	mm A	Weight (kg/pc)				Pcs/Ctn
			Part Number	PVC	Part Number	CPVC	
1/2"	20	30.0	542-012	0.02	542-012C	0.02	100
3/4"	25	34.0	542-034	0.03	542-034C	0.03	75
1"	32	38.0	542-100	0.04	542-100C	0.05	60
1-1/4"	40	42.0	542-114	0.07	542-114C	0.08	50
1-1/2"	50	46.0	542-112	0.11	542-112C	0.12	40
2"	63	52.0	542-200	0.15	542-200C	0.16	30
2-1/2"	75	60.0	542-212	0.26	542-212C	0.28	20
3"	90	65.5	542-300	0.40	542-300C	0.47	15
4"	110	79.6	542-400	0.52	542-400C	0.58	10

**LD-543** Plug  
Tapón Macho  
Male Thread  
Rosca Macho

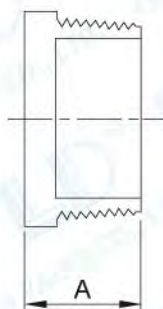

Unit / mm-kg

ASTM Inch	DIN d(mm)	mm A	Weight (kg/pc)				Pcs/Ctn
			Part Number	PVC	Part Number	CPVC	
1/2"	20	24.4	543-012	0.01	543-012C	0.01	100
3/4"	25	24.9	543-034	0.02	543-034C	0.02	75
1"	32	27.9	543-100	0.03	543-100C	0.03	60
1-1/4"	40	32.5	543-114	0.05	543-114C	0.60	50
1-1/2"	50	33.0	543-112	0.06	543-112C	0.70	40
2"	63	36.6	543-200	0.09	543-200C	0.10	30
2-1/2"	75	50.0	543-212	0.14	543-212C	0.15	20
3"	90	52.1	543-300	0.20	543-300C	0.22	15
4"	110	54.6	543-400	0.34	543-400C	0.37	10



## LD-556 Reducing Bushing Buje de Reducción

Male Socket (Spigot) X Socket  
Encolar Macho (Espita) X Encolar

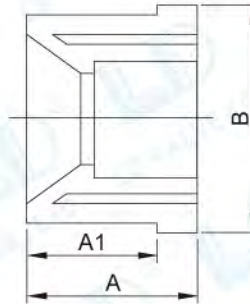

Unit / mm-kg

ASTM Inch	DIN d x d1(mm)	mm			Weight (kg/pc)				Pcs/Ctn
		A	A1	B	Part Number	PVC	Part Number	CPVC	
3/4" x 1/2"	25 x 20	32.0	23.0	30.0	556-034C	0.01	556-034CC	0.01	100
1" x 1/2"	32 x 20	35.0	23.0	38.0	556-100C	0.03	556-100CC	0.03	100
1" x 3/4"	32 x 25	35.0	26.0	38.0	556-100D	0.02	556-100CD	0.02	100
1-1/4" x 1/2"	40 x 20	40.0	23.0	46.0	556-114C	0.05	556-114CC	0.06	75
1-1/4" x 3/4"	40 x 25	40.0	26.0	46.0	556-114D	0.05	556-114CD	0.05	75
1-1/4" x 1"	40 x 32	40.0	29.0	46.0	556-114E	0.04	556-114CE	0.04	75
1-1/2" x 1/2"	50 x 20	43.0	23.0	53.0	556-112C	0.07	556-112CC	0.07	50
1-1/2" x 3/4"	50 x 25	43.0	26.0	53.0	556-112D	0.07	556-112CD	0.08	50
1-1/2" x 1"	50 x 32	43.0	29.0	53.0	556-112E	0.06	556-112CE	0.06	50
1-1/2" x 1-1/4"	50 x 40	43.0	32.0	53.0	556-112F	0.03	556-112CF	0.04	50
2" x 1/2"	63 x 20	50.0	23.0	66.0	556-200C	0.11	556-200CC	0.13	40
2" x 3/4"	63 x 25	50.0	26.0	66.0	556-200D	0.11	556-200CD	0.13	40
2" x 1"	63 x 32	50.0	29.0	66.0	556-200E	0.12	556-200CE	0.13	40
2" x 1-1/4"	63 x 40	50.0	32.0	66.0	556-200F	0.10	556-200CF	0.11	40
2" x 1-1/2"	63 x 50	50.0	35.0	66.0	556-200G	0.09	556-200CG	0.10	40
2-1/2" x 1-1/2"	75 x 50	55.0	35.0	78.0	556-212G	0.16	556-212CG	0.18	30
2-1/2" x 2"	75 x 63	55.0	39.0	78.0	556-212H	0.12	556-212CH	0.13	30
3" x 1"	90 x 32	58.0	29.0	94.0	556-300E	0.24	556-300CE	0.27	20
3" x 1-1/2"	90 x 50	58.0	35.0	94.0	556-300G	0.26	556-300CG	0.29	20
3" x 2"	90 x 63	58.0	39.0	94.0	556-300H	0.24	556-300CH	0.27	20
3" x 2-1/2"	90 x 75	58.0	45.0	94.0	556-300I	0.17	556-300CI	0.20	15
4" x 1"	110 x 32	70.0	29.0	120	556-400E	0.54	556-400CE	0.60	12
4" x 1-1/4"	110 x 40	70.0	32.0	120	556-400F	0.60	556-400CF	0.67	12
4" x 1-1/2"	110 x 50	70.0	35.0	120	556-400G	0.59	556-400CG	0.67	12
4" x 2"	110 x 63	70.0	39.0	120	556-400H	0.46	556-400CH	0.51	12
4" x 2-1/2"	110 x 75	70.0	45.0	120	556-400I	0.42	556-400CI	0.47	12
4" x 3"	110 x 90	70.0	48.0	120	556-400J	0.35	556-400CJ	0.39	12
6" x 3"	160 x 90	92.0	48.0	175	556-600J	1.12	556-600CJ	1.25	10
6" x 4"	160 x 110	92.0	58.0	175	556-600L	1.25	556-600CL	1.39	10
8" x 4"	200 225 x 110	120	58	230	556-800L	2.18	556-800CL	2.43	8
8" x 6"	200 225 x 160	120	77	230	556-800P	2.45	556-800CP	2.74	8
10" x 6"	250 280 x 160	160	77	285	556-1000P	4.18	556-1000CP	4.66	8
10" x 8"	250 280 x 225	160	102	285	556-1000S	4.64	556-1000CS	5.18	8
12" x 6"	315 x 160	174	78	340	556-1200P	7.26	556-1200CP	8.11	4
12" x 8"	315 x 200 225	174	103	340	556-1200S	7.57	556-1200CS	8.45	2
12" x 10"	315 x 250 280	174	140	340	556-1200T	6.61	556-1200CT	7.38	2



## LD-557 Reducing Bushing with Female Thread Buje de Reducción con Rosca Hembra

Male Socket (Spigot) X Female Thread  
Encolar Macho (Espita) x Rosca Hembra

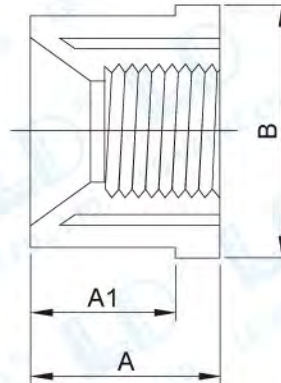

Unit / mm-kg

ASTM Inch	DIN d x d1(mm)	mm			Weight (kg/pc)				Pcs/Ctn
		A	A1	B	Part Number	PVC	Part Number	CPVC	
3/4" x 1/2"	25 x 20	32.0	23.0	30.0	557-034C	0.01	557-034CC	0.01	100
1" x 1/2"	32 x 20	35.0	23.0	38.0	557-100C	0.03	557-100CC	0.03	100
1" x 3/4"	32 x 25	35.0	26.0	38.0	557-100D	0.02	557-100CD	0.02	100
1-1/4" x 1/2"	40 x 20	40.0	23.0	46.0	557-114C	0.05	557-114CC	0.06	75
1-1/4" x 3/4"	40 x 25	40.0	26.0	46.0	557-114D	0.05	557-114CD	0.06	75
1-1/4" x 1"	40 x 32	40.0	29.0	46.0	557-114E	0.04	557-114CE	0.04	75
1-1/2" x 1/2"	50 x 20	43.0	23.0	53.0	557-112C	0.07	557-112CC	0.07	50
1-1/2" x 3/4"	50 x 25	43.0	26.0	53.0	557-112D	0.07	557-112CD	0.08	50
1-1/2" x 1"	50 x 32	43.0	29.0	53.0	557-112E	0.06	557-112CE	0.06	50
1-1/2" x 1-1/4"	50 x 40	43.0	32.0	53.0	557-112F	0.03	557-112CF	0.04	50
2" x 1/2"	63 x 20	50.0	23.0	66.0	557-200C	0.12	557-200CC	0.14	40
2" x 3/4"	63 x 25	50.0	26.0	66.0	557-200D	0.12	557-200CD	0.14	40
2" x 1"	63 x 32	50.0	29.0	66.0	557-200E	0.12	557-200CE	0.14	40
2" x 1-1/4"	63 x 40	50.0	32.0	66.0	557-200F	0.11	557-200CF	0.12	40
2" x 1-1/2"	63 x 50	50.0	35.0	66.0	557-200G	0.09	557-200CG	0.11	40
2-1/2" x 1-1/2"	75 x 50	55.0	35.0	78.0	557-212G	0.17	557-212CG	0.19	30
2-1/2" x 2"	75 x 63	55.0	39.0	78.0	557-212H	0.13	557-212CH	0.14	30
3" x 1"	90 x 32	58.0	29.0	94.0	557-300E	0.25	557-300CE	0.28	20
3" x 1-1/2"	90 x 50	58.0	35.0	94.0	557-300G	0.27	557-300CG	0.30	20
3" x 2"	90 x 63	58.0	39.0	94.0	557-300H	0.25	557-300CH	0.28	20
3" x 2-1/2"	90 x 75	58.0	45.0	94.0	557-300I	0.18	557-300CI	0.21	15
4" x 1"	110 x 32	70.0	29.0	120	557-400E	0.57	557-400CE	0.63	12
4" x 1-1/4"	110 x 40	70.0	32.0	120	557-400F	0.63	557-400CF	0.70	12
4" x 1-1/2"	110 x 50	70.0	35.0	120	557-400G	0.62	557-400CG	0.70	12
4" x 2"	110 x 63	70.0	39.0	120	557-400H	0.48	557-400CH	0.54	12
4" x 2-1/2"	110 x 75	70.0	45.0	120	557-400I	0.44	557-400CI	0.49	12
4" x 3"	110 x 90	70.0	48.0	120	557-400J	0.37	557-400CJ	0.41	12
6" x 4"	160 x 110	92.0	58.0	175	557-600L	1.31	557-600CL	1.46	10
8" x 4"	200 225 x 110	120	58.0	230	557-800L	2.29	557-800CL	2.55	8



## Combination Chart of Reducing Bushing

#: Bushing without Bushing #B: With 1 additional Bushing #BB: With 2 additional Bushing

		Bushing													
		1/2"	3/4"	1"	1-1/4"	1-1/2"	2"	2-1/2"	3"	4"	5"	6"	8"	10"	12"
Bushing	1/2"														
	3/4"	#													
	1"	#	#												
	1-1/4"	#	#	#											
	1-1/2"	#	#	#	#										
	2"	#	#	#	#	#									
	2-1/2"	#B	#B	#B	#B	#	#								
	3"	#B	#B	#	#B	#	#	#							
	4"	#B	#B	#	#	#	#	#	#						
	5"	#BB	#BB	#B	#B	#B	#B	#B	#B	#					
	6"	#BB	#BB	#B	#B	#B	#B	#B	#	#	#				
	8"	#BB	#BB	#B	#B	#B	#B	#B	#B	#	#B	#			
10"			#BB	#BB	#BB	#BB	#BB	#BB	#B	#B	#	#			
12"			#BB	#BB	#BB	#BB	#BB	#BB	#B	#B	#	#	#		

## LD-558 Male Thread Bushing with Socket Buje de Reducción Rosca Macho con Encolar

Male Thread X Socket  
Rosca Macho X Encolar

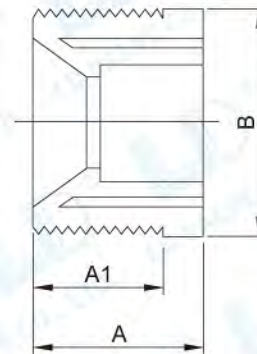

Unit / mm-kg

ASTM Inch	DIN d x d1(mm)	mm A	mm A1	mm B	Weight (kg/pc)			Pcs/Ctn	
					Part Number	PVC	Part Number		CPVC
3/4" x 1/2"	25 x 20	32.0	23.0	30.0	558-034C	0.02	558-034CC	0.02	100
1" x 1/2"	32 x 20	35.0	23.0	38.0	558-100C	0.03	558-100CC	0.03	100
1" x 3/4"	32 x 25	35.0	26.0	38.0	558-100D	0.02	558-100CD	0.03	100
1-1/4" x 1/2"	40 x 20	40.0	23.0	46.0	558-114C	0.06	558-114CC	0.07	75
1-1/4" x 3/4"	40 x 25	40.0	26.0	46.0	558-114D	0.06	558-114CD	0.06	75
1-1/4" x 1"	40 x 32	40.0	29.0	46.0	558-114E	0.04	558-114CE	0.04	75
1-1/2" x 1/2"	50 x 20	43.0	23.0	53.0	558-112C	0.08	558-112CC	0.08	50
1-1/2" x 3/4"	50 x 25	43.0	26.0	53.0	558-112D	0.08	558-112CD	0.09	50
1-1/2" x 1"	50 x 32	43.0	29.0	53.0	558-112E	0.07	558-112CE	0.07	50
1-1/2" x 1-1/4"	50 x 40	43.0	32.0	53.0	558-112F	0.03	558-112CF	0.04	50
2" x 1/2"	63 x 20	50.0	23.0	66.0	558-200C	0.12	558-200CC	0.14	40
2" x 3/4"	63 x 25	50.0	26.0	66.0	558-200D	0.13	558-200CD	0.14	40
2" x 1"	63 x 32	50.0	29.0	66.0	558-200E	0.13	558-200CE	0.14	40
2" x 1-1/4"	63 x 40	50.0	32.0	66.0	558-200F	0.11	558-200CF	0.12	40
2" x 1-1/2"	63 x 50	50.0	35.0	66.0	558-200G	0.10	558-200CG	0.11	40
2-1/2" x 1-1/2"	75 x 50	55.0	35.0	78.0	558-212G	0.18	558-212CG	0.20	30
2-1/2" x 2"	75 x 63	55.0	39.0	78.0	558-212H	0.13	558-212CH	0.14	30
3" x 1"	90 x 32	58.0	29.0	94.0	558-300E	0.26	558-300CE	0.30	20
3" x 1-1/2"	90 x 50	58.0	35.0	94.0	558-300G	0.29	558-300CG	0.32	20
3" x 2"	90 x 63	58.0	39.0	94.0	558-300H	0.26	558-300CH	0.30	20
3" x 2-1/2"	90 x 75	58.0	45.0	94.0	558-300I	0.19	558-300CI	0.22	15
4" x 1"	110 x 32	70.0	29.0	120	558-400E	0.60	558-400CE	0.66	12
4" x 1-1/4"	110 x 40	70.0	32.0	120	558-400F	0.66	558-400CF	0.74	12
4" x 1-1/2"	110 x 50	70.0	35.0	120	558-400G	0.65	558-400CG	0.74	12
4" x 2"	110 x 63	70.0	39.0	120	558-400H	0.51	558-400CH	0.56	12
4" x 2-1/2"	110 x 75	70.0	45.0	120	558-400I	0.46	558-400CI	0.52	12
4" x 3"	110 x 90	70.0	48.0	120	558-400J	0.39	558-400CJ	0.43	12



## LD-559 Male Thread Bushing with Female Thread Buje de Reducción Rosca Macho con Rosca Hembra

Male Thread X Female Thread  
Rosca Macho X Rosca Hembra

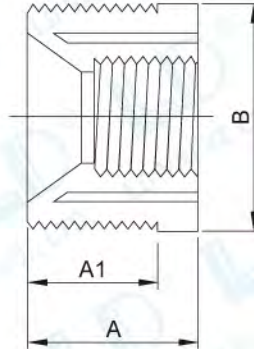

Unit / mm-kg

ASTM Inch	DIN d x d1(mm)	mm			Weight (kg/pc)				Pcs/Ctn
		A	A1	B	Part Number	PVC	Part Number	CPVC	
3/4" x 1/2"	25 x 20	32.0	23.0	30.0	559-034C	0.02	559-034CC	0.02	100
1" x 1/2"	32 x 20	35.0	23.0	38.0	559-100C	0.03	559-100CC	0.03	100
1" x 3/4"	32 x 25	35.0	26.0	38.0	559-100D	0.02	559-100CD	0.03	100
1-1/4" x 1/2"	40 x 20	40.0	23.0	46.0	559-114C	0.06	559-114CC	0.07	75
1-1/4" x 3/4"	40 x 25	40.0	26.0	46.0	559-114D	0.06	559-114CD	0.06	75
1-1/4" x 1"	40 x 32	40.0	29.0	46.0	559-114E	0.05	559-114CE	0.05	75
1-1/2" x 1/2"	50 x 20	43.0	23.0	53.0	559-112C	0.08	559-112CC	0.08	50
1-1/2" x 3/4"	50 x 25	43.0	26.0	53.0	559-112D	0.08	559-112CD	0.09	50
1-1/2" x 1"	50 x 32	43.0	29.0	53.0	559-112E	0.07	559-112CE	0.07	50
1-1/2" x 1-1/4"	50 x 40	43.0	32.0	53.0	559-112F	0.03	559-112CF	0.05	50
2" x 1/2"	63 x 20	50.0	23.0	66.0	559-200C	0.13	559-200CC	0.15	40
2" x 3/4"	63 x 25	50.0	26.0	66.0	559-200D	0.13	559-200CD	0.15	40
2" x 1"	63 x 32	50.0	29.0	66.0	559-200E	0.14	559-200CE	0.15	40
2" x 1-1/4"	63 x 40	50.0	32.0	66.0	559-200F	0.12	559-200CF	0.13	40
2" x 1-1/2"	63 x 50	50.0	35.0	66.0	559-200G	0.10	559-200CG	0.12	40
2-1/2" x 1-1/2"	75 x 50	55.0	35.0	78.0	559-212G	0.19	559-212CG	0.21	30
2-1/2" x 2"	75 x 63	55.0	39.0	78.0	559-212H	0.14	559-212CH	0.15	30
3" x 1"	90 x 32	58.0	29.0	94.0	559-300E	0.28	559-300CE	0.31	20
3" x 1-1/2"	90 x 50	58.0	35.0	94.0	559-300G	0.30	559-300CG	0.34	20
3" x 2"	90 x 63	58.0	39.0	94.0	559-300H	0.28	559-300CH	0.31	20
3" x 2-1/2"	90 x 75	58.0	45.0	94.0	559-300I	0.20	559-300CI	0.23	15
4" x 1"	110 x 32	70.0	29.0	120	559-400E	0.62	559-400CE	0.69	12
4" x 1-1/4"	110 x 40	70.0	32.0	120	559-400F	0.69	559-400CF	0.78	12
4" x 1-1/2"	110 x 50	70.0	35.0	120	559-400G	0.68	559-400CG	0.78	12
4" x 2"	110 x 63	70.0	39.0	120	559-400H	0.53	559-400CH	0.59	12
4" x 2-1/2"	110 x 75	70.0	45.0	120	559-400I	0.49	559-400CI	0.54	12
4" x 3"	110 x 90	70.0	48.0	120	559-400J	0.41	559-400CJ	0.45	12



## LD-561 Male Adapter

### Adaptador Macho

Socket X Male Thread  
Encolar X Rosca Macho

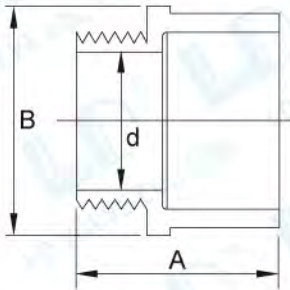

Unit / mm-kg

ASTM	DIN	mm			Weight (kg/pc)				Pcs/Ctn
Inch	d(mm)	A	d	B	Part Number	PVC	Part Number	CPVC	
1/2"	20	46.0	14.0	34.0	561-012	0.02	561-012C	0.03	75
3/4"	25	50.0	19.0	39.0	561-034	0.03	561-034C	0.03	50
1"	32	56.0	24.0	47.0	561-100	0.04	561-100C	0.05	40
1-1/4"	40	63.0	32.0	58.0	561-114	0.06	561-114C	0.07	40
1-1/2"	50	66.0	38.0	64.1	561-112	0.09	561-112C	0.10	28
2"	63	73.0	50.0	77.0	561-200	0.12	561-200C	0.14	30
2-1/2"	75	93.0	62.0	94.0	561-212	0.22	561-212C	0.24	24
3"	90	98.0	72.0	111	561-300	0.30	561-300C	0.34	12
4"	110	112	96.0	139	561-400	0.51	561-400C	0.57	18

## LD-566 Reducing Male Adapter

### Adaptador Macho Reducido

Socket X Male Thread  
Encolar X Rosca Macho

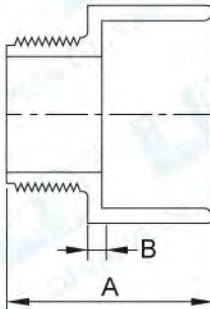

Unit / mm-kg

ASTM	DIN	mm		Weight (kg/pc)				Pcs/Ctn
Inch	d x d1(mm)	A	B	Part Number	PVC	Part Number	CPVC	
3/4" x 1/2"	25 x 20	53.6	5.84	566-034C	0.03	566-034CC	0.03	100
1" x 1/2"	32 x 20	59.9	9.40	566-100C	0.04	566-100CC	0.05	75
1" x 3/4"	32 x 25	59.9	5.84	566-100D	0.04	566-100CD	0.05	75
1-1/4" x 1/2"	40 x 20	68.1	14.0	566-114C	0.07	566-114CC	0.07	75
1-1/4" x 3/4"	40 x 25	68.1	10.9	566-114D	0.06	566-114CD	0.07	75
1-1/4" x 1"	40 x 32	68.1	7.62	566-114E	0.07	566-114CE	0.08	75
1-1/2" x 1/2"	50 x 20	74.9	17.8	566-112C	0.09	566-112CC	0.09	50
1-1/2" x 3/4"	50 x 25	74.9	14.7	566-112D	0.08	566-112CD	0.09	50
1-1/2" x 1"	50 x 32	74.9	11.4	566-112E	0.09	566-112CE	0.10	50
1-1/2" x 1-1/4"	50 x 40	74.9	8.38	566-112F	0.10	566-112CF	0.11	50
2" x 1/2"	63 x 20	83.1	22.6	566-200C	0.12	566-200CC	0.13	40
2" x 3/4"	63 x 25	83.1	19.6	566-200D	0.12	566-200CD	0.13	40
2" x 1"	63 x 32	83.1	16.3	566-200E	0.13	566-200CE	0.14	40
2" x 1-1/4"	63 x 40	83.1	13.2	566-200F	0.14	566-200CF	0.15	40
2" x 1-1/2"	63 x 50	83.1	9.91	566-200G	0.15	566-200CG	0.16	40

## LD-571 Female Adapter

### Adaptador Hembra

Socket X Female Thread  
Encolar X Rosca Hembra

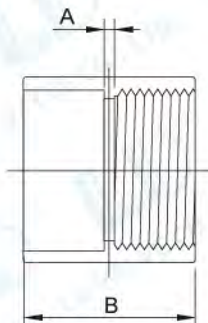

Unit / mm-kg

ASTM	DIN	mm		Weight (kg/pc)				Pcs/Ctn
Inch	d(mm)	A	B	Part Number	PVC	Part Number	CPVC	
1/2"	20	5.59	50.0	571-012	0.03	571-012C	0.03	75
3/4"	25	5.21	56.0	571-034	0.04	571-034C	0.05	50
1"	32	5.84	63.0	571-100	0.06	571-100C	0.07	40
1-1/4"	40	5.51	69.0	571-114	0.10	571-114C	0.11	40
1-1/2"	50	5.13	75.0	571-112	0.15	571-112C	0.15	28
2"	63	8.79	85.0	571-200	0.22	571-200C	0.24	30
2-1/2"	75	7.11	96.0	571-212	0.34	571-212C	0.37	24
3"	90	6.73	102	571-300	0.52	571-300C	0.56	12
4"	110	8.71	123	571-400	0.78	571-400C	0.85	18



## LD-572 Female by Female Adapter

### Adaptador Hembra por Hembra

Female Thread  
Rosca Hembra

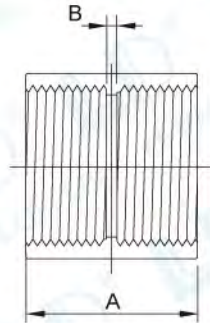

Unit / mm-kg

ASTM	DIN	mm		Weight (kg/pc)				Pcs/Ctn
Inch	d(mm)	A	B	Part Number	PVC	Part Number	CPVC	
1/2"	20	50.0	5.59	572-012	0.04	572-012C	0.04	75
3/4"	25	56.0	5.21	572-034	0.05	572-034C	0.05	50
1"	32	63.0	5.84	572-100	0.07	572-100C	0.08	40
1-1/4"	40	69.0	5.51	572-114	0.12	572-114C	0.13	40
1-1/2"	50	75.0	5.13	572-112	0.16	572-112C	0.18	28
2"	63	85.0	8.79	572-200	0.25	572-200C	0.27	30
2-1/2"	75	96.0	7.11	572-212	0.39	572-212C	0.42	24
3"	90	102	6.73	572-300	0.59	572-300C	0.64	12
4"	110	123	8.71	572-400	0.91	572-400C	0.99	18

## LD-577 Reducing Female by Female Adapter

### Adaptador Hembra por Hembra Reducido

Female Thread  
Rosca Hembra

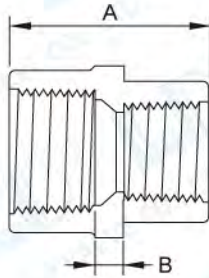

Unit / mm-kg

ASTM	DIN	mm		Weight (kg/pc)				Pcs/Ctn
Inch	d x d1(mm)	A	B	Part Number	PVC	Part Number	CPVC	
3/4" x 1/2"	25 x 20	53.6	5.84	577-034C	0.03	577-034CC	0.03	100
1" x 1/2"	32 x 20	59.9	9.40	577-100C	0.05	577-100CC	0.04	75
1" x 3/4"	32 x 25	59.9	5.84	577-100D	0.04	577-100CD	0.05	75
1-1/4" x 1/2"	40 x 20	68.1	14.0	577-114C	0.07	577-114CC	0.08	75
1-1/4" x 3/4"	40 x 25	68.1	10.9	577-114D	0.07	577-114CD	0.07	75
1-1/4" x 1"	40 x 32	68.1	7.62	577-114E	0.08	577-114CE	0.08	75
1-1/2" x 1/2"	50 x 20	74.9	17.8	577-112C	0.09	577-112CC	0.10	50
1-1/2" x 3/4"	50 x 25	74.9	14.7	577-112D	0.09	577-112CD	0.10	50
1-1/2" x 1"	50 x 32	74.9	11.4	577-112E	0.10	577-112CE	0.11	50
1-1/2" x 1-1/4"	50 x 40	74.9	8.38	577-112F	0.11	577-112CF	0.12	50
2" x 1/2"	63 x 20	83.1	22.6	577-200C	0.12	577-200CC	0.13	40
2" x 3/4"	63 x 25	83.1	19.6	577-200D	0.13	577-200CD	0.13	40
2" x 1"	63 x 32	83.1	16.3	577-200E	0.14	577-200CE	0.15	40
2" x 1-1/4"	63 x 40	83.1	13.2	577-200F	0.15	577-200CF	0.15	40
2" x 1-1/2"	63 x 50	83.1	9.91	577-200G	0.16	577-200CG	0.17	40

## LD-581 Cross

### Cruz

Socket  
Encolar

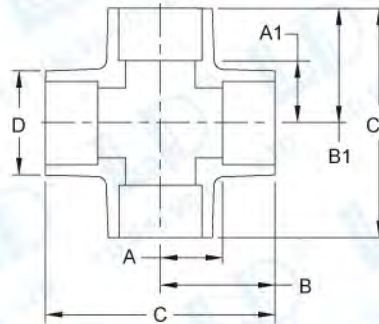

Unit / mm-kg

ASTM	DIN	mm							Weight (kg/pc)				Pcs/Ctn
Inch	d(mm)	A	A1	B	B1	C	C1	D	Part Number	PVC	Part Number	CPVC	
1/2"	20	14.3	14.3	37.3	37.3	74.6	74.6	30.2	581-012	0.06	581-012C	0.06	75
3/4"	25	15.9	15.9	41.3	41.3	83.3	83.3	35.7	581-034	0.10	581-034C	0.10	50
1"	32	24.6	24.6	53.2	53.2	107	107	43.7	581-100	0.17	581-100C	0.21	40
1-1/4"	40	27.8	27.8	60.3	60.3	121	121	54.0	581-114	0.29	581-114C	0.29	40
1-1/2"	50	31.8	31.8	66.7	66.7	133	133	60.3	581-112	0.36	581-112C	0.39	28
2"	63	42.9	42.9	88.1	88.1	175	175	89.7	581-200	0.63	581-200C	0.65	30
2-1/2"	75	38.1	38.1	42.9	42.9	88.1	88.1	155	581-212	0.92	581-212C	0.96	24
3"	90	42.9	42.9	88.1	88.1	175	175	89.7	581-300	1.50	581-300C	1.54	12
4"	110	66.7	66.7	124	124	248	248	133	581-400	2.41	581-400C	2.49	18



## LD-820 Union

### Unión

Socket  
Encolar  
O-Ring: EPDM, FPM, NBR

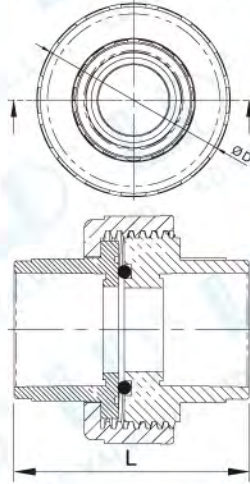

Unit / mm-kg

ASTM	DIN	mm		Weight (kg/pc)				Pcs/Ctn
Inch	d(mm)	$\phi$ D	L	Part Number	PVC	Part Number	CPVC	
1/2"	20	50	59.4	820-012	0.06	820-012C	0.07	180
3/4"	25	60	64.4	820-034	0.10	820-034C	0.11	120
1"	32	69	70.9	820-100	0.12	820-100C	0.13	100
1-1/4"	40	79	88.9	820-114	0.20	820-114C	0.21	100
1-1/2"	50	93	103.8	820-112	0.30	820-112C	0.31	60
2"	63	111	117.1	820-200	0.46	820-200C	0.47	36
2-1/2"	75	139	144.0	820-212	0.89	820-212C	0.90	18
3"	90	158	157.1	820-300	1.23	820-300C	1.24	12
4"	110	171	211.5	820-400	1.89	820-400C	1.90	8
6"	160	287	216.4	820-600	4.86	820-600C	4.87	2

## LD-821 Union

### Unión

Female Thread  
Rosca Hembra  
O-Ring: EPDM, FPM, NBR

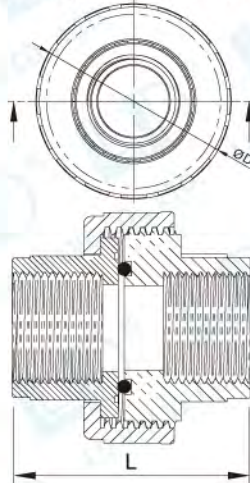

Unit / mm-kg

ASTM	DIN	mm		Weight (kg/pc)				Pcs/Ctn
Inch	d(mm)	$\phi$ D	L	Part Number	PVC	Part Number	CPVC	
1/2"	20	50	59.4	821-012	0.06	821-012C	0.07	180
3/4"	25	60	64.4	821-034	0.11	821-034C	0.11	120
1"	32	69	70.9	821-100	0.13	821-100C	0.13	100
1-1/4"	40	79	88.9	821-114	0.21	821-114C	0.22	100
1-1/2"	50	93	103.8	821-112	0.32	821-112C	0.33	60
2"	63	111	117.1	821-200	0.48	821-200C	0.51	36
2-1/2"	75	139	144.0	821-212	0.93	821-212C	0.98	18
3"	90	158	157.1	821-300	1.29	821-300C	1.36	12
4"	110	171	211.5	821-400	1.98	821-400C	2.08	8
6"	160	287	216.4	821-600	5.10	821-600C	5.36	2

## LD-550

### Universal Union

## LD-551

### Unión Universal

## LD-552

## LD-553

O-Ring: EPDM, FPM, NBR

- Easily adaptable to any type of connection.
- Any combination is available on request.

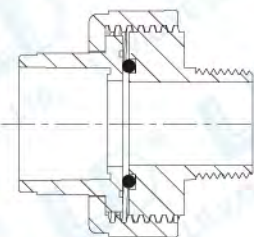

### LD-550

Socket X Male Thread  
Encolar X Rosca Macho

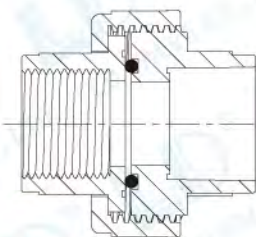

### LD-551

Female Thread X Socket  
Rosca Hembra X Encolar

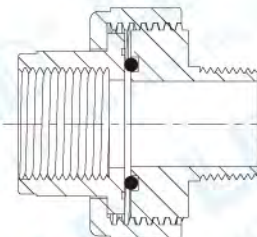

### LD-552

Female Thread X Male Thread  
Rosca Hembra X Rosca Macho

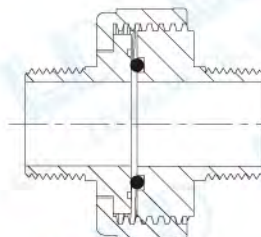

### LD-553

Male Thread X Male Thread  
Rosca Macho X Rosca Macho



## LD-822D Van Stone Flange

### Brida Van Stone

Socket  
Encolar

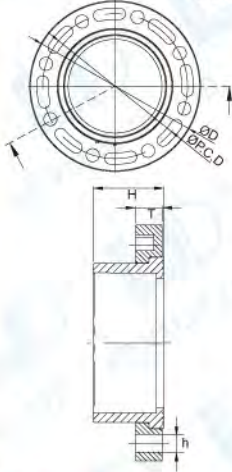

ASTM Inch	DIN d(mm)	mm					ANSI(mm)		DIN(mm)		Weight (kg/pc)				Pcs/Ctn
		ψD	H	T	h	PCD	Hole	PCD	Hole	Part Number	PVC	Part Number	CPVC		
1/2"	20	100	26	15.1	16.0	60.3	4	65	4	822D-012	0.11	822D-012C	0.11	72	
3/4"	25	100	29	15.1	16.0	69.8	4	75	4	822D-034	0.12	822D-034C	0.13	72	
1"	32	125	24	15.1	16.0	79.4	4	85	4	822D-100	0.20	822D-100C	0.21	60	
1-1/4"	40	127	35	16.2	16.0	88.9	4	100	4	822D-114	0.25	822D-114C	0.26	48	
1-1/2"	50	140	38	18.0	16.0	98.4	4	110	4	822D-112	0.28	822D-112C	0.29	48	
2"	63	152	40	20.0	19.0	121.0	4	125	4	822D-200	0.40	822D-200C	0.42	40	
2-1/2"	75	175	54	23.0	19.0	140.0	4	145	4	822D-212	0.64	822D-212C	0.67	32	
3"	90	192	54	26.0	19.0	152.0	4	160	8	822D-300	0.73	822D-300C	0.76	24	
4"	110	229	63	28.0	19.0	191.0	8	180	8	822D-400	1.26	822D-400C	1.32	16	
6"	160	284	85	32.0	22.0	241.0	8	240	8	822D-600	1.98	822D-600C	2.07	8	
8"	200/225	343	116	36.0	22.0	298.0	8	295	8	822D-800	2.86	822D-800C	3.00	6	
10"	250/280	406	148	42.0	25.4	362.0	12	350	12	822D-1000	4.82	822D-1000C	5.06	2	
12"	315	482	173	42.0	25.4	432.0	12	400	12	822D-1200	7.95	822D-1200C	8.35	2	
14"	355	533	203	51.0	28.4	476.0	12	460	16	822D-1400	11.70	822D-1400C	12.29	1	
16"	400	597	225	60.0	28.4	540.0	16	515	16	822D-1600	16.90	822D-1600C	17.75	1	

Unit / mm-kg

## LD-822DT Van Stone Flange

### Brida Van Stone

Female Thread  
Rosca Hembra

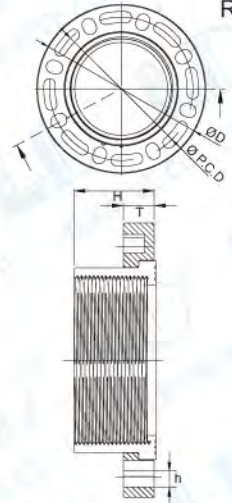

ASTM Inch	DIN d(mm)	mm					ANSI(mm)		DIN(mm)		BSPT	BSP	NPT	NPS	Weight (kg/pc)				Pcs/Ctn
		ψD	H	T	h	PCD	Hole	PCD	Hole	thd/in	thd/in	thd/in	thd/in	Part Number	PVC	Part Number	CPVC		
1/2"	20	100	26	15.1	16.0	60.3	4	65	4	14	14	14	14	822DT-012	0.11	822DT-012C	0.12	72	
3/4"	25	100	29	15.1	16.0	69.8	4	75	4	14	14	14	14	822DT-034	0.13	822DT-034C	0.13	72	
1"	32	125	24	15.1	16.0	79.4	4	85	4	11	11	11.5	11.5	822DT-100	0.21	822DT-100C	0.22	60	
1-1/4"	40	127	35	16.2	16.0	88.9	4	100	4	11	11	11.5	11.5	822DT-114	0.26	822DT-114C	0.27	48	
1-1/2"	50	140	38	18.0	16.0	98.4	4	110	4	11	11	11.5	11.5	822DT-112	0.29	822DT-112C	0.31	48	
2"	63	152	40	20.0	19.0	121.0	4	125	4	11	11	11.5	11.5	822DT-200	0.42	822DT-200C	0.44	40	
2-1/2"	75	175	54	23.0	19.0	140.0	4	145	4	11	11	8	8	822DT-212	0.67	822DT-212C	0.71	32	
3"	90	192	54	26.0	19.0	152.0	4	160	8	11	11	8	8	822DT-300	0.76	822DT-300C	0.80	24	
4"	110	229	63	28.0	19.0	191.0	8	180	8	11	11	8	8	822DT-400	1.32	822DT-400C	1.39	16	
6"	160	284	85	32.0	22.0	241.0	8	240	8	11	11	8	8	822DT-600	2.07	822DT-600C	2.18	8	
8"	200/225	343	116	36.0	22.0	298.0	8	295	8	11	11	8	8	822DT-800	3.00	822DT-800C	3.15	6	
10"	250/280	406	148	42.0	25.4	362.0	12	350	12	11	11	8	8	822DT-1000	5.06	822DT-1000C	5.31	2	
12"	315	482	173	42.0	25.4	432.0	12	400	12	11	11	8	8	822DT-1200	8.35	822DT-1200C	8.76	2	
14"	355	533	203	51.0	28.4	476.0	12	460	16	11	11	8	8	822DT-1400	12.29	822DT-1400C	12.90	1	
16"	400	597	225	60.0	28.4	540.0	16	515	16	11	11	8	8	822DT-1600	17.75	822DT-1600C	18.63	1	

Unit / mm-kg

## LD-822S Spigot Flange

### Brida Espita

Male Socket (Spigot)  
Encolar Macho (Espita)

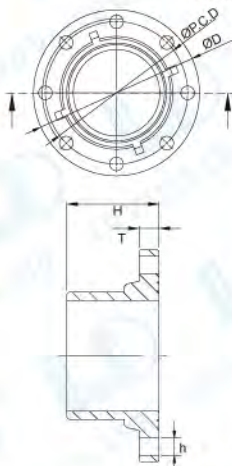

ASTM Inch	DIN d(mm)	mm					ANSI(mm)		DIN(mm)		Weight (kg/pc)				Pcs/Ctn
		ψD	H	T	h	PCD	Hole	PCD	Hole	Part Number	PVC	Part Number	CPVC		
1/2"	20	100	46	14.0	16.0	60.3	4	65	4	822S-012	0.10	822S-012C	0.11	100	
3/4"	25	100	43	15.0	16.0	69.8	4	75	4	822S-034	0.12	822S-034C	0.13	96	
1"	32	125	45	15.0	16.0	79.4	4	85	4	822S-100	0.17	822S-100C	0.17	72	
1-1/4"	40	127	52	16.0	16.0	88.9	4	100	4	822S-114	0.21	822S-114C	0.22	48	
1-1/2"	50	140	54	18.0	16.0	98.4	4	110	4	822S-112	0.32	822S-112C	0.33	36	
2"	63	152	58	20.6	19.0	121.0	4	125	4	822S-200	0.47	822S-200C	0.49	32	
2-1/2"	75	175	68	22.5	19.0	140.0	4	145	4	822S-212	0.72	822S-212C	0.75	24	
3"	90	192	64	24.0	19.0	152.0	4	160	8	822S-300	0.87	822S-300C	0.91	18	
4"	110	229	82	24.0	19.0	191.0	8	180	8	822S-400	1.21	822S-400C	1.27	12	
6"	160	284	112	26.0	22.0	241.0	8	240	8	822S-600	2.21	822S-600C	2.32	8	
8"	200/225	343	118	29.0	22.0	298.0	8	295	8	822S-800	3.29	822S-800C	3.45	6	
10"	250/280	406	155	42.0	25.0	362.0	12	350	12	822S-1000	5.69	822S-1000C	5.97	2	
12"	315	482	182	42.0	25.0	432.0	12	400	12	822S-1200	9.94	822S-1200C	10.44	2	

Unit / mm-kg

**NOTE:** Mix standard JIS, ANSI, DIN, Thread available.



## LD-822C One Piece Flange

### Brida de Una Pieza

Socket  
Encolar

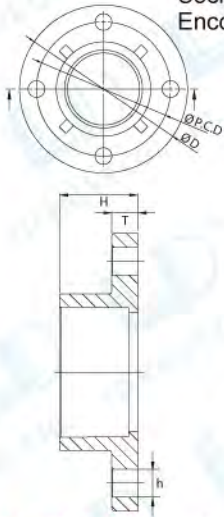

Unit / mm-kg

ASTM Inch	DIN d(mm)	mm				ANSI(mm)		Weight (kg/pc)				Pcs/Ctn
		$\phi$ D	H	T	h	PCD	Hole	Part Number	PVC	Part Number	CPVC	
1/2"	20	100	25	11.7	16.0	60.3	4	822C-012	0.09	822C-012C	0.09	128
3/4"	25	100	30	13.1	16.0	69.8	4	822C-034	0.12	822C-034C	0.13	96
1"	32	125	32	15.2	16.0	79.4	4	822C-100	0.19	822C-100C	0.20	72
1-1/4"	40	127	38	16.9	16.0	88.9	4	822C-114	0.24	822C-114C	0.25	60
1-1/2"	50	140	41	18.3	16.0	98.4	4	822C-112	0.31	822C-112C	0.33	32
2"	63	152	45	19.0	19.0	121.0	4	822C-200	0.46	822C-200C	0.48	36
2-1/2"	75	175	51	25.0	19.0	140.0	4	822C-212	0.72	822C-212C	0.75	18
3"	90	192	51	25.5	19.0	152.0	4	822C-300	0.88	822C-300C	0.92	18
4"	110	229	63	28.4	19.0	191.0	8	822C-400	1.34	822C-400C	1.41	12
6"	160	284	85	26.0	22.0	241.0	8	822C-600	2.22	822C-600C	2.33	8
8"	200/225	343	116	29.0	22.0	298.0	8	822C-800	3.40	822C-800C	3.57	4

## LD-822CT One Piece Flange

### Brida de Una Pieza

Thread  
Rosca

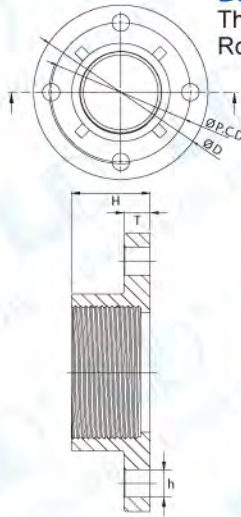

Unit / mm-kg

ASTM Inch	DIN d(mm)	mm				ANSI(mm)		BSPT	BSP	NPT	NPS	Weight (kg/pc)				Pcs/Ctn
		$\phi$ D	H	T	h	PCD	Hole	thd/in	thd/in	thd/in	thd/in	Part Number	PVC	Part Number	CPVC	
1/2"	20	100	25	11.7	16.0	60.3	4	14	14	14	14	822CT-012	0.09	822CT-012C	0.10	128
3/4"	25	100	30	13.1	16.0	69.8	4	14	14	14	14	822CT-034	0.13	822CT-034C	0.13	96
1"	32	125	32	15.2	16.0	79.4	4	11	11	11.5	11.5	822CT-100	0.20	822CT-100C	0.21	72
1-1/4"	40	127	38	16.9	16.0	88.9	4	11	11	11.5	11.5	822CT-114	0.25	822CT-114C	0.26	60
1-1/2"	50	140	41	18.3	16.0	98.4	4	11	11	11.5	11.5	822CT-112	0.33	822CT-112C	0.34	32
2"	63	152	45	19.0	19.0	121.0	4	11	11	11.5	11.5	822CT-200	0.48	822CT-200C	0.50	36
2-1/2"	75	175	51	25.0	19.0	140.0	4	11	11	8	8	822CT-212	0.75	822CT-212C	0.79	18
3"	90	192	51	25.5	19.0	152.0	4	11	11	8	8	822CT-300	0.92	822CT-300C	0.97	18
4"	110	229	63	28.4	19.0	191.0	8	11	11	8	8	822CT-400	1.41	822CT-400C	1.48	12
6"	160	284	85	26.0	22.0	241.0	8	11	11	8	8	822CT-600	2.33	822CT-600C	2.45	8
8"	200/225	343	116	29.0	22.0	298.0	8	11	11	8	8	822CT-800	3.57	822CT-800C	3.75	4

## LD-822E Blind Flange

### Brida Ciega

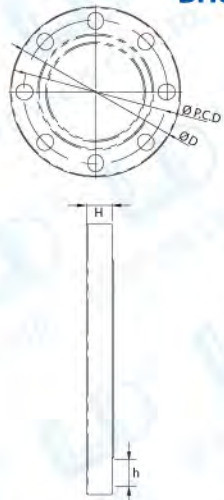

Unit / mm-kg

ASTM Inch	DIN d(mm)	mm			ANSI(mm)		DIN(mm)		Weight (kg/pc)				Pcs/Ctn
		$\phi$ D	H	h	PCD	Hole	PCD	Hole	Part Number	PVC	Part Number	CPVC	
1/2"	20	100	12	16.0	60.3	4	60.3	4	822E-012	0.10	822E-012C	0.10	120
3/4"	25	100	13	16.0	69.8	4	69.8	4	822E-034	0.10	822E-034C	0.10	120
1"	32	108	15	16.0	79.4	4	79.4	4	822E-100	0.18	822E-100C	0.18	72
1-1/4"	40	117	16	16.0	88.9	4	88.9	4	822E-114	0.21	822E-114C	0.22	60
1-1/2"	50	127	18	16.0	98.4	4	98.4	4	822E-112	0.23	822E-112C	0.24	60
2"	63	152	20	19.0	121.0	4	121.0	4	822E-200	0.34	822E-200C	0.35	48
2-1/2"	75	175	23	19.0	140.0	4	140.0	4	822E-212	0.51	822E-212C	0.52	28
3"	90	191	24	19.0	152.0	4	152.0	8	822E-300	0.64	822E-300C	0.67	24
4"	110	229	24	19.0	191.0	8	191.0	8	822E-400	0.87	822E-400C	0.91	20
6"	160	284	24	22.0	241.0	8	241.0	8	822E-600	1.53	822E-600C	1.60	12
8"	200/225	343	26	22.0	298.0	8	298.0	8	822E-800	2.25	822E-800C	2.36	8
10"	250/280	406	28	25.0	362.0	12	362.0	12	822E-1000	3.64	822E-1000C	3.82	5
12"	315	483	43	25.0	432.0	12	400.0	12	822E-1200	6.19	822E-1200C	6.50	2

NOTE: Mix standard JIS, ANSI, DIN, Thread available.



## SOLVENT CEMENT WELDING JOINTS

### Joining Equipment and Material



- Cutting Tool
- Saw & Pipe Cutter (Ratchet Type, Wheel Type)
- Pipe deburring & beveling tool, file or knife
- Solvent Cement
- PVC cement for PVC materials, CPVC cement for CPVC materials
- Primer
- Cleaner
- Cotton Rag
- Square
- Marking Pen
- Tape Measure
- Brush



### 1. Cutting ①②

Pipe ends must be cut squarely.

Check the pipe end with a square to make sure it has been cut squarely.

**Note:** A diagonal cut will reduce bonding area in the most critical part of the joint.

Wheel type cutters are not recommended for large diameters since they tend to raise flare at the pipe end.

Flares must be removed with a file or deburring tool, since it will scrape the cement away while inserting pipe into the fitting.

### 2. Deburring ③

All burrs, chips, filings, etc. around the pipe must be removed before joining.

Use a knife, deburring tool or a half-round coarse file.

All pipe ends should be beveled by 45 degrees.

**Note:** Failure to chamfer the edge of the pipe may remove cement from the fitting socket, causing the joint to leak.

### 3. Inspection and Cleaning ④⑤

Visually inspect the inside of the pipe and fitting sockets.

Remove all dirt, grease or moisture with a clean dry rag.

Check pipe and fitting for potential damages such as splits or cracks and replace if necessary.

### 4. Testing Dry Fit of the Joint

Check pipe and fitting for dry fit before cementing.

The pipe should be inserted to the fitting easily for about 1/3 to 2/3 of the socket depth.

### 5. Depth-Of-Entry Mark ⑥

Mark the socket depth of the fitting on the pipe O.D..

This reference mark can be used to ensure the pipe is completely bottomed into the fitting when jointing.



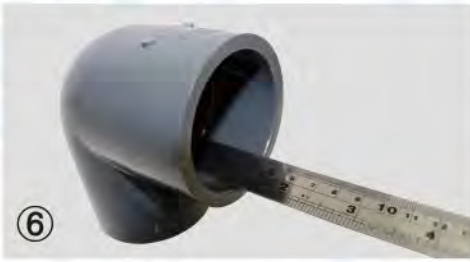

## 6. Priming ⑦

This step is necessary to penetrate and soften both pipe and fitting socket surfaces for cementing process.

Apply a layer of primer to the surface of the pipe and fitting socket with a natural bristle brush.

Proceed immediately to the cementing procedure before the primer dries.



### Recommended Brush Size for Primer and Cement Application

Nominal Pipe Size	1/2"	3/4"	1"	1-1/4"	1-1/2"	2"	2-1/2"	3"	4"	5"	6"	8"	10"	12"
Brush Width	1/2"	1"	1"	1"	1-1/2"	1-1/2"	1-1/2" to 2"	1-1/2" to 2-1/2"	2"	3"	3"	4"	6"	6"

\* Use Only Natural Bristle

### Applicators

Select a suitable pure bristle type paint brush. Use a brush or roller with proper width to apply the primer and cement.

Speedy application of cement is important due to its fast drying characteristics.

**IMPORTANT NOTE:** A dauber type applicator should only be used on pipe sizes of 2" or below. For larger diameter pipe, a brush, swab, or roller must be used.



## 7. Application of Solvent Cement ⑧

While the primer is still wet, apply the solvent cement evenly and quickly around the outside of the pipe at a width a little larger than the depth of the fitting socket.

Lightly coat the inside of the fitting socket with the cement.

Apply a second coat of cement to the pipe end.

**NOTE:** Read all warnings on primer and cement containers before the installation.



## 8. Joint Assembly ⑨

Insert the pipe into the fitting socket bottom with a one-quarter turn to evenly distribute the cement. This procedure should be operated quickly and smoothly.

Do not continue to rotate the pipe after it has reached the bottom of the fitting socket.

A good joint will have sufficient cement to make a bead all the way around the outside of the fitting hub.

Hold the pipe and fitting together for at least 30 seconds to make sure the pipe has a good bond with the fitting.

## 9. Clean Up

Remove all excess cement around the pipe and fitting with a dry cotton rag while the cement is still soft.

## 10. Initial Set Time

Initial set time is the necessary time to allow the joint to create enough bonds before it could be carefully handled.

### Recommended Initial Set Time

Temperature Range	Pipe Sizes 1/2" to 1-1/4"	Pipe Sizes 1-1/2" to 2"	Pipe Sizes 2-1/2" to 8"	Pipe Sizes 10" to 15"	Pipe Sizes 15"+
60°F to 100°F / 15°C to 40°C	2 min	5 min	30 min	2 hrs	4 hrs
40°F to 60°F / 5°C to 15°C	5 min	10 min	2 hrs	8 hrs	16 hrs
0°F to 40°F / -17°C to 5°C	10 min	15 min	12 hrs	24 hrs	48 hrs

**Note:** In damp or humid environment, please allow 50% more set time.



## 11. Joint cure time

Joint cure time is the necessary time for the joint to be strong enough before pressurizing system.

### Recommended Joint Cure Time

Temperature range during assembly and cure periods	Pipe Sizes 1/2" to 1-1/4"	Pipe Sizes 1-1/2" to 2"	Pipe Sizes 2-1/2" to 8"	Pipe Sizes 10" to 15"	Pipe Sizes 15"+
	up to 150psi / 1MPa	up to 150psi / 1MPa	up to 150psi / 1MPa	up to 100psi / 0.7MPa	up to 100psi / 0.7 MPa
60°F to 100°F / 15°C to 40°C	1 hour	2 hours	6 hours	48 hours	72 hours
40°F to 60°F / 5°C to 15°C	2 hours	4 hours	12 hours	96 hours	6 days
20°F to 40°F / -5°C to 5°C	8 hours	16 hours	72 hours	8 days	14 days

### Helpful Hints

1. Process quickly and carefully.
2. Use enough amount of fresh cement.
3. Do not attempt cementing in the presence of moisture or in the rain.
4. Do not cement when the temperature is below 40°F/5°C or above 90°F/32°C under direct sunlight.
5. Do not take shortcuts or bypass recommended steps.
6. Consult your cement manufacturer for specific questions or problems.

### Applicable Specification for Solvent Welding

- ASTM D 2564 : Solvent cements for PVC thermoplastic pipe and fitting.
- ASTM D 2855 : Marking solvent cemented joist with PVC pipe and fitting.
- ASTM A 493 : Solvent cements for CPVC thermoplastic pipe and fitting.
- ASTM A 656 : Primers for use in solvent cement joints of PVC thermoplastic pipe and fitting.

## 12. Hydrostatic Pressure Testing

### WARNING

AIR/GAS



Failure to follow the safety precautions below may result in misapplication or improper installation and testing which can cause severe personal injury and/or property damage.

1. All joints should be fully cured before filling the system with water.
2. All valves should be opened and air relief mechanisms should be installed at relative high points angles. Fill the system slowly with water and precautions; flow velocities should be slower than 1 foot per second. This will prevent surge, water hammer, and air entrapment.
3. Continue to fill water until all entrapped air is completely flushed out. Maintain the 1 ft/s velocity until every valve is checked. A sudden fluctuation of pressure (indicated by gauge needle) during pressure rise may be an indication that entrapped air still remains in the system. Systems should include proper air relief and vacuum breaker valves to vent air out during normal operations after installation. Entrapped air is the major cause of surge and burst failure in thermoplastic piping systems.
4. After the system is filled, do not pressurize until the responsible engineer is present to witness the test. All personnel should wear safety glasses and helmet. High voltage electrical equipment should be protected in case of leak or spray.
5. The piping system should be pressurized to 1.25 times of its maximum designed operating pressure. This pressure must not exceeds 1.5 times of the working pressure of the lowest rated component in the system, such as flanges, unions, thread parts, valves, etc.
6. The pressure test should be under 1 hour. This should provide enough time for inspections of leaks or other potential defects of the system. If leaks are found, pressure must be relieved for repair. The system should then be recharged and retested. Consult the factory if you have any questions concerning these steps.



## THREAD CONNECTIONS

### 1. Cutting and Deburring

PVC or CPVC pipe should be cut squarely and smooth for easy and accurate threading. A miter box or similar guide should be used when sawing is done by hand. Burrs should be removed from inside and outside using a knife or thermoplastic pipe deburring tool.

### 2. Threading Pipe

Threading PVC and CPVC pipe can be accomplished easily using either a standard hand pipe stock or a power operated tool. Cutting dies should be clean and sharp. Power threading machines should be fitted with dies having a 5° negative front rake and ground especially for thermoplastic pipe. Self-opening die heads, and a slight chamfer to lead the dies could speed up the operation; however, dies should not be driven with heavy pressure or at high speeds. In case of using a hand held cutter, the pipe should be fixed in a pipe vise. To prevent crushing or scoring of the pipe by the vice jaws, protective wrap should be applied such as canvas, emery paper, rubber, or light metal sleeve. For hand stocks, the dies should have a negative front rake angle of 5° to 10°. PVC and CPVC material could be threaded easily; caution should be taken to avoid over-thread.

### 3. Apply Teflon\* Tape

After threading, a ring gauge should be used to check the accuracy of the threads. Tolerance should be within  $\pm 1\text{-}1/2$  turns. The threads should then be cleaned. After cleaning, apply a thread lubricant such as Teflon\* tape to the threads. Wrap the tape around the entire length of threads beginning with the second thread from the end. The tape should slightly overlap itself while going in the same direction as the threads. This will prevent the tape from unraveling when the fitting is being tightened on the pipe. Overlapping in the wrong direction and the use of too much tape can affect tolerances between threads. This could generate stress on the wall of female fittings and cause failures during operation.

### 4. Assembly of Thread Joints

After applying Teflon\*, screw the thread fitting onto the pipe. Screwed fittings should be started carefully and hand tightened only. Threads must be properly cut and covered with good quality thread Teflon\*/tape. If desired, the joint may be tightened with a strap wrench.

Do not use a stillson type wrench. The jaws of this type of wrench will scar and damage the pipe surface. Thread assembly should be tighten until hand tight with an additional 1 to 1-1/2 turns. Avoid stretching or distorting the pipe, fittings or threads from over tightening.

#### NOTE:

- (1) Never apply solvent cement to thread pipe or thread fittings. Do not allow cleaners, primers, or solvent cements to "run" or drip into the thread portion of the fitting.
- (2) Some Teflon pastes contain chemicals that may be harmful to the pipe and fittings. You should consult the supplier or manufacturer of the paste before use.
- (3) Avoid screwing metallic male threads into thermoplastic female threads. We recommend flanged end connections for joining a metal system to a plastic system.

There are a variety of thermoplastic fittings that are designed with metallic male or NPT female thread inserts. The corrosion resistance of the metal insert will have to be taken into consideration. Consult the factory or your LD sales person for the availability of these metal-insert fittings.

\*Trademark of the E.I. DuPont Company.



## FLANGE CONNECTIONS

### 1. Selection of Materials

LD Gasket must be resistant to chemicals flowing through it.

Fasteners-bolts, nuts, and washers also need to be resistant to the chemical environment.

(Threads should be well lubricated.)

Torque Wrench is required for tightening bolts in a manner that prevents excessive torque.

### 2. Flange Assembly

1. Join the flange to the pipe as outlined with the solvent cementing or the threading section depending on the joining method desired.

2. Align the flanges and gasket by inserting all of the bolts through the matching bolt holes. Proper mating of flanges and gaskets is very important for a positive seal.

3. Use a torque wrench and tighten each bolt in a gradual sequence as outlined by the flange sketch. For final tightening of all bolts, find the recommended torque value in the chart below.



### CAUTION

1. Do not over-torque flange bolts.
2. Use the proper bolt tightening sequence.
3. Make sure the system is in proper alignment.
4. Flanges should not be used to draw piping assemblies together.
5. Flat washers must be used under every nut and bolt head.

### Recommended Torque

Size	Approx. Bolt Length* in.	Recommended Torque ft./lbs.
1/2"	2-1/2	10-15
3/4"	2-1/2	10-15
1"	2-1/2	10-15
1 1/4"	3	10-15
1 1/2"	3	10-15
2"	3-1/2	20-30
2 1/2"	3	20-30
3"	3-1/2	20-30
4"	4	20-30
6"	4	33-50
8"	5	33-50
10"	5	53-75
12"	5	80-110

Bolt lengths were calculated using two LD flanges. Additional accessories or different mating surfaces will alter these numbers

**NOTE:** Flange's bolt hole pattern meets ANSI B16.5

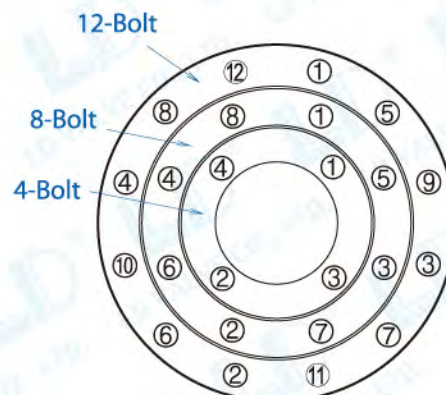



Piping systems made of PVC & CPVC will provide an excellent, maintenance-free performance over many years of use, as long as the application and system design is correct and properly installed. It is important to know the properties and limitations of PVC and CPVC thermoplastic pipe when selecting these materials. Always start with reading and following installation indications first. It is very important to know the reputation and abilities of your installation crew or contractor. Professional engineering design of the system and close supervision of the installation process is highly recommended.

Any questions about the installation procedure and applications of PVC and CPVC piping products should be directed to your supplier, manufacturer or consultant.

## WARNING

Failure to follow the safety precautions below may result in misapplication or improper installation and testing which can cause severe personal injury and/or property damage.

### General

#### 1. Avoid contact with hard and/or pointed objects to protect thermoplastic pipe

Impact resistance is lower than metal pipes.

#### 2. Keep pipe away from extreme heat and cold.

Extremes heat and/or cold can cause failure. If liquids freeze inside PVC/CPVC and/or metallic piping can cause the pipe and/or the joints to crack. Freeze protection should be designed into the system. Heat beyond designed limits can also cause failures.

#### 3. Protect pipe from sunlight.

PVC and CPVC pipe compounds normally do not provide extended protection from the ultraviolet rays of the sun. Therefore, unless the material has been specially formulated to sustain in this environment, the product must be protected from sunlight or it may reduce product's durability.

#### 4. Avoid bending pipe

Pipe should not be bent in trenches or in above ground installations. Pipe and joints that are stressed reduce pressure rating and can cause failures.

### Application

#### 1. PVC and CPVC piping system is not made for transporting compressed air or gases.

Compressed air or gases can surge to high pressures and cause explosive failures that could seriously injure personnel. PVC and CPVC pipe and fittings are excellent products in transporting water and corrosive chemicals.

#### 2. Only use chemicals that are proved to be safe to transport with PVC/CPVC pipes.

Certain chemicals, especially petroleum distillates and derivatives, can cause damage to the system. Every chemical should be verified and approved in the manufacturer's chemical resistance chart.

### System Design

#### 1. Allow for flexibility in the design of the system.

Expansion and contraction is greater than metals. This can cause cracks and leaking points if system is not designed flexible enough to absorb movement. When laying smaller diameters of pipe below ground, the pipe should be "snaked" in the trench to allow for expansion and contraction. If solvent cement welding is used for the method of joining, snaking, pressure testing, and pipe movement should not be done until after the joints have been given sufficient time to set.



## **2. Design safeguards into the system to prevent excessive surge pressures.**

Water hammer (surge) in a PVC and CPVC system can cause pipe, fittings, and valves to burst. Liquid velocities should not exceed the maximum speed of 5 ft/s.

### **Installation**

#### **1. Carefully follow solvent cement welding instructions.**

Failure to follow application indications can reduce the strength and integrity of joints and cause joint failures. By far, the majority of failures in PVC and CPVC systems are the result of shortcuts and/or improper joining techniques.

#### **2. Remove rocks and other debris that may damage pipe before burying pipe in trenches.**

Precaution should be taken to remove all rocks, boards, empty primer and cement cans, brushes, bottles and other debris from the trench when laying PVC and CPVC pipe below the ground. Backfilling and top loading should be supervised.

#### **3. Follow recommended support spacing for PVC and CPVC piping systems.**

The modulus of elasticity of PVC and CPVC pipe is smaller than metals. Maximum working temperature and room temperature should be considered when determining the required support spacing.

### **Testing**

#### **1. NEVER use compressed air or gas or air-over-water boosters to pressure test PVC or CPVC piping systems.**

ONLY hydrostatic pressure testing should be conducted on PVC and CPVC piping systems. Compressed air or gases can surge to high pressures and cause explosive failures that could seriously injure personnel.

#### **2. Carefully follow all instructions for hydrostatic pressure testing.**

Failure to follow these instructions can result in a system failure.

#### **3. Always remove all entrapped air from system before water-testing a system.**

Entrapped air is a major cause of surge and burst failure in thermoplastic piping systems.

## **STORAGE AND MANAGEMENT**

### **Buyer's Acceptance of Materials**

Upon receiving the pipes, the person in charge should always inspect the products as much as possible before unloading. The receiver should check for transportation damage such as a shift in the load, tie-down straps over-tightened, or signs of rough treatment. LTL (less than truckload) pipe shipments that arrive in a closed trailer should be checked as soon as the trailer is opened. Make sure that the pipe has not been top-loaded with metallic pipes, crates, machinery or any other objects that might crush or damage the thermoplastic pipe. The ends of the pipe should be visually inspected for cracks, cuts, gouges, or heavy deformations. In some cases, especially for large diameter pipe (4" and above), it would be advisable to inspect the opening of the pipes for internal cracks or splits that may have occurred as a result of loading or transportation. The use of a strong flashlight may be necessary to inspect the inside diameter beyond the ends of the pipe. Any and all damages should be witnessed by the truck driver and clearly noted on the transportation documentation with a copy retained by the receiver. The carrier and LD should be immediately notified of any damages or missing pipe, or items incorrectly shipped.



## Unloading and Handling

While transporting pipes, please make sure they are well palletized and will not rolling around when the truck is moving. Upon arrival to the destination, the person in charge to receive the delivery should inspect the goods for any damage occurred during the transportation. After the pipe has been thoroughly inspected and inventoried, it should be unloaded according to the following indications. The person receiving the pipe must decide the method to unload the pipes and is responsible for any damage that occurs during the unloading process. Never push or drag a palletized load of pipe from a truck bed. Do not throw the pipes directly to the ground from the truck bed. This could cause serious damage to the pipe's outer surface such as scratches and bends on the openings. Pipe should not come into severe contact with sharp objects such as edges or corners of truck beds, loading docks and buildings, forks on forklift trucks, and rocks or other objects on the ground.

Forks of forklifts must never be inserted straight into the openings of the pipe for lifting or moving the loads. Any unbalanced force during the unloading process could cause permanent bends to the pipe. And it's potentially dangers since the pipe may be bouncing and cause personal injury.

**NOTE:** The impact resistance and flexibility of PVC and especially CPVC pipe are weakened by low temperature environments. The impact strength for both types of piping materials will decrease as temperatures drops to 32°F (0°C) and/or below. Extreme care should be taken when unloading and handling pipe in such cold weather. Dropping pipe from a truck or forklift may cause cracks or other damages. Methods and techniques normally used in warm weather may not be appropriate at the lower temperature range.

## Pipe Storage

While storing the pipes indoor, use pipe rack that offer sufficient support to the whole length. Loose pipe lengths should be stored in racks or dunnage that will evenly support the pipe to prevent longitudinal sag. If pipe is not well supported, especially in warmer weather, it will become permanently bowed and could increase installation difficulties. It's recommended to have support at least every three feet and keep the pipe stack lower than eight feet.

While storing pipes indoor is preferred but that may not always be convenient. In case of storing pipes outdoors, choose a flat and dry location that will minimize dirt and foreign matter accumulation in the bore. Wooden pallet bracings should be used to hold the pipes in place. It's recommended to support the stack with a minimum space of three feet between each wooden pallet bracings with a minimum width of 75mm. Stack height will depend on the pipe diameter, the slope of the terrain, and the weather conditions. As a general precaution, palletized pipe should not be stacked higher than the recommended height in the indoor situation which is eight feet. This should be determined and approved by the site engineer or responsible management official. The pipe must be protected from the sun and extreme heat. Protect the pipe by covering it with an opaque tarp, leaving the ends open to allow for air circulation through and around the pipe. This will provide a shade that keeps the sun light away. If pipe is not protected from the sun, discoloration may occur due to extended exposure to ultraviolet rays. This may take years to happen depending on the geographic location and the orientation of the pipe to the sun.

## Fitting Storage

Upon receiving the fittings, the person in charge should take an accurate count of the incoming order and report any discrepancies to LD and the carrier. Fittings packaged in damaged boxes should be closely inspected. Always store fittings in their original package, if they must be removed from their boxes, categorize them by material type (PVC or CPVC), geometric configuration, and diameter size.

Never combine your thermoplastic fitting inventory with metallic materials. Keep fittings away from open flame or source of extreme heat.





# LIMITED WARRANTY

## LIMITED WARRANTY

LD products are warranted to be free from manufacturing defects in material and workmanship for a period of 5 (five) years from the date of original purchases.

If the customer receives any goods that appear to be defective, upon receipt written notice to LD VALVE, the customer with permission can return prepaid such questionable goods. After examination, if the goods are proven to be defective due to manufacture or material provided by the company, LD VALVE may repair, replace or reimburse the customer for such goods. The customer must make all claims under these warranties, and no claim will be accepted from a third party. Warranties are non-transferable. Any product repaired or replaced under warranty is only warranted for the period of time remaining in the original warranty for the product. All costs of shipping such questionable goods to or from LD VALVE shall be borne by the customer.

**This shall be the customer's only remedy.**

The acceptance by LD VALVE of any product returned is not an admission that the product is defective, and if LD VALVE determines the product is not covered by this Limited Warranty, the product will be returned to the Buyer at Buyer's expense.

Failure to meet payment obligations voids all warranties and does not extend the Limited Warranty period when payment is made. Warranty ceases to exist immediately if the object delivered is altered or overhauled.

Warranty does not cover damage caused by one or more of the following:

1. LD products that have been subject to abuse, misuse, neglect, accident, fire, improper installation, storage, handling or adjustment, or corrosion.
2. Natural disaster, including but not limited to, fire, flood, hurricane, tornado, earthquake, electro-static or any other similar natural cause beyond the control of LD VALVE.
3. LD products that have been modified or altered outside of or beyond LD's specifications.
4. LD products used in application other than those recommended by LD.
5. Damage by liquid with temperature lower than 4°C/40°F or higher than 60°C/140°F (PVC) and 95°C/203°F (CPVC) at no pressure.

For detail, please refer to temperature/working pressure graph.

LD VALVE's liability is limited to the replacement cost of product and is not responsible for consequential damages. Freight charges, installation cost, labor cost, damage to related components, and cost incurred due to down time, from normal wear and tear of the valve is not covered by this warranty. There are no other warranties provided other than stated herein. LD VALVE reserves the right to change dimensions, specifications, or prices without prior notice.

**DO NOT USE LD PRODUCTS FOR COMPRESSED AIR OR GASES.**

**DO NOT TEST THERMOPLASTIC PIPING SYSTEMS WITH COMPRESSED AIR OR GASES.**

**DO NOT USE PIPING SYSTEMS WITH LIQUIDS NOT RECOMMENDED BY LD.**

**MODIFICATIONS OF LD PRODUCTS VOIDS THE WARRANTY.**





*Innovation · Quality · Service · Integrity*  
*Innovación · Calidad · Servicio · Integridad*

**We Will Keep Improving and Make Every Effort to Meet Your Needs.**

**[www.LDVALVE.com](http://www.LDVALVE.com)**

**LD VALVE Since 1974**

E-mail: [THOMAS@LDVALVE.COM](mailto:THOMAS@LDVALVE.COM)

TEL: 886-4-26396399

FAX: 886-4-26397555

No. 388, Tzuchiang Rd., Wuchi Dist., Taichung City, Taiwan, 43547