

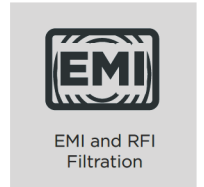

## GENERATOR-COMPATIBLE TOWER UPS

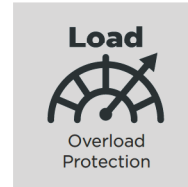
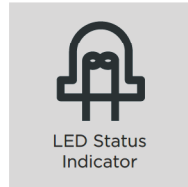
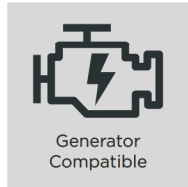
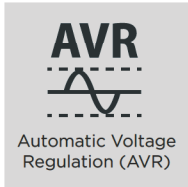
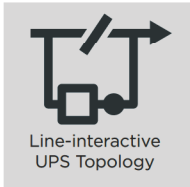

### The compact UPS compatible with generators to provide power protection

Designed for home, SOHO office and office applications, the UT Series adopts line-interactive topology with Automatic Voltage Regulation (AVR) function to offer stabilized AC power output. The products are compatible with generators to extend power continuity. Other features include overload protection and configurable alarm to safeguard your devices.

#### APPLICATION

- Home
- Office
- SOHO Office

#### SERIES FEATURES

- Line-interactive UPS Topology
- Generator Compatible
- Phone/Fax/Modem/DSL/Network Protection
- Surge and Spike Protection
- Configurable Alarm
- Tower Form Factor
- Automatic Voltage Regulation (AVR)
- LED Status Indicator
- Overload Protection
- EMI and RFI Filtration
- PowerPanel® Management Software\*

\*Selected Model(s)

#### PRODUCT CALLOUTS

1. Power On Indicator
2. Power On/Off Switch
3. Battery Capacity Indicators
4. Battery Backup Outlets
5. Battery Backup & Surge Protected Outlets
6. Communication Protection Ports RJ11/RJ45
7. Input Circuit Breaker
8. AC Input Power Cord
9. USB Port

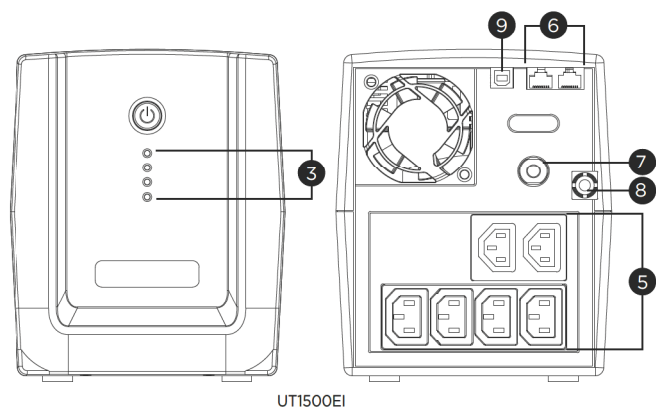
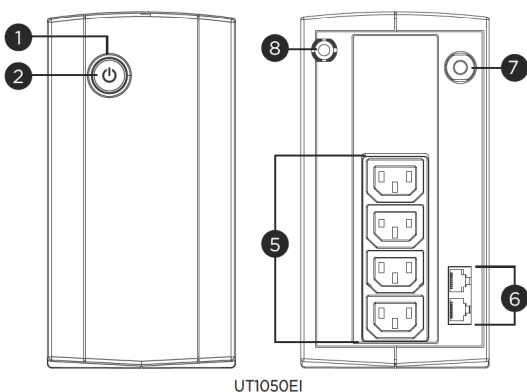



**TECHNICAL SPECIFICATIONS**

Model Name	UT1050EI	UT1500EI
<b>General</b>		
UPS Topology	Line-interactive	Line-interactive
<b>Input</b>		
Generator Compatibility	Yes	Yes
Nominal Input Voltage (Vac)	230 ± 10%	230 ± 10%
Input Voltage Range (Vac)	165 - 290	165 - 290
Input Frequency (Hz)	50 ± 5, 60 ± 5	50 ± 10, 60 ± 10
Input Frequency Detection	Auto-sensing	Auto-sensing
Rated Input Current (A)	4.77	6.82
Input Connector Type	UK	UK
<b>Output</b>		
Capacity (VA)	1050	1500
Capacity (Watts)	630	900
On Battery Waveform	Simulated Sine Wave	Simulated Sine Wave
On Battery Voltage(s) (Vac)	230 ± 10%	230 ± 10%
On Battery Frequency (Hz)	50 ± 1%, 60 ± 1%	50 ± 1%, 60 ± 1%
Automatic Voltage Regulation (AVR)	Single Boost, Single Buck	Single Boost, Single Buck
Overload Protection	Circuit Breaker	Circuit Breaker
Outlet(s) - Total	4	6
Outlet Type	IEC C13 x 4	IEC C13 x 6
Outlet(s) - Battery & Surge Protected	4	6
Outlet(s) - Battery Backup	-	-
Typical Transfer Time (ms)	4	4
<b>Battery</b>		
Runtime at 60W (min)	65	90
Runtime at 90W (min)	43	60
Typical Recharge Time (Hours)	8	8
User-replaceable	No	No
Battery Type	Sealed Lead-acid	Sealed Lead-acid
<b>Surge Protection &amp; Filtering</b>		
Surge Suppression (Joules)	125	125
EMI/RFI Filtration	Yes	Yes
Phone/Network Protection RJ11/RJ45 (Combo)	1-in, 1-out	1-in, 1-out
<b>Management &amp; Communications</b>		
LED Indicators	Power On, Line Mode, Battery Mode, Low Battery	Power On, Line Mode, Battery Mode, Battery Capacity, Low Battery
HID Compliant USB Port(s)	-	1
Audible Alarms	Battery Mode, Low Battery, Overload, UPS Fault	Battery Mode, Low Battery, Overload, UPS Fault
Power Management Software	-	PowerPanel® Personal
<b>Physical</b>		
Form Factor	Tower	Tower
<b>Physical Size - UPS Module</b>		
Dimensions (WxHxD) (mm.)	100 x 189 x 325	148 x 178 x 298
Weight (kg.)	6.9	9.1
<b>Environmental</b>		
Operating Temperature (°C)	0 - 40	0 - 40
Operating Relative Humidity (Non-condensing) (%)	0 - 90	0 - 90
Online Thermal Dissipation (BTU/hr)	45	102
<b>Certifications</b>		
Certifications*	CE	CE
RoHS	Yes	Yes

\*Certifications may vary according to different regions. Visit [www.cyberpower.com](http://www.cyberpower.com) for more information.  
 #All specifications are subject to change without notice.