

**testo 6681 · Humidity transmitters
testo 6610 · Probes
P2A software · Parameterizing, adjusting and analyzing
software**

Instruction manual Volume 2

en

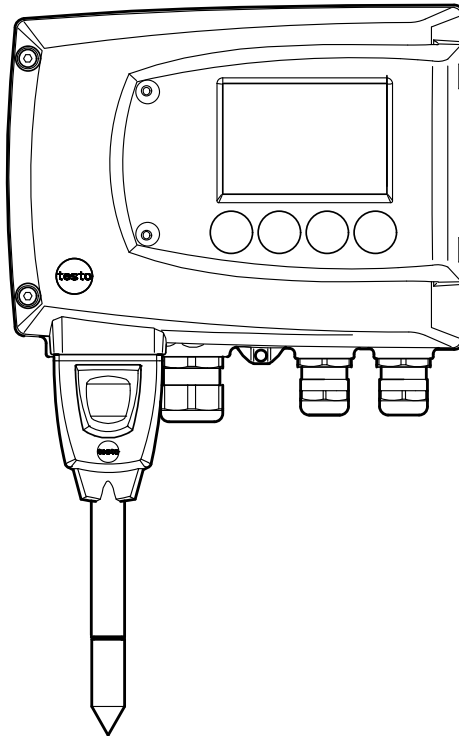

Contents

2	TESTO 6610 PROBES	73
2.1	Specifications.....	73
2.1.1	Functions and use.....	73
2.1.2	Design of the probe.....	75
2.1.3	Accessories.....	76
2.2	Product description.....	76
2.2.1	Overview of probe and filter types	76
2.2.2	testo 6611 wall probe.....	81
2.2.3	testo 6612 duct probe.....	84
2.2.4	testo 6613 cable probe.....	88
2.2.5	testo 6614 heated cable probe	92
2.2.6	testo 6615 trace humidity cable probe (self-adjustment).....	95
2.2.7	testo 6617 cable probe (self-monitoring)	99
2.3	Commissioning	103
2.3.1	Installing the probe.....	103
2.3.2	Connecting/removing the probe to/from the transmitter	107
2.4	Maintenance and cleaning.....	108
2.4.1	Replacing filters/protection caps	108
2.4.2	Cleaning the instrument and filter/protection cap	111
2.4.3	Replacing the sensor	111
3	PARAMETERIZING, ADJUSTING AND ANALYZING SOFTWARE (P2A SOFTWARE)	112
3.1	Specifications.....	112
3.1.1	Functions and use.....	112
3.1.2	System requirements	113
3.1.3	Scope of delivery.....	113
3.2	First steps	114
3.2.1	Installing the software/driver	114
3.2.2	Starting the software	115
3.3	Using the software	116
3.3.1	User interface.....	116
3.3.2	Editing instrument/parameter file	118
3.3.3	Analyzing/testing the transmitter.....	128
3.3.4	Adjusting the transmitter	134
3.3.5	Transmitter history	139

4	TIPS AND ASSISTANCE	145
4.1	Questions and answers	145
4.2	Accessories and spare parts	146
4.2.1	Ordering options for testo 6681 transmitter (0555 6681).....	149
4.2.2	Ordering options for testo 6610 probes (0555 6610).....	153

2 testo 6610 probes

2.1 Specifications

2.1.1 Functions and use

The plug-in, adjusted probes from the testo 6610 range are used in conjunction with the testo 6681 humidity transmitter.

These measuring units are suitable for the following applications, for example:

- Process instrumentation
- Clean rooms
- Test benches
- Drying processes
- Production and storage air quality
- Complex room climate applications.

2.1.1.1 Digital probes:

The probes are adjusted in the factory and transmit their adjustment data to the internal memory of the testo 6681 transmitter. The information is transmitted between the probe and transmitter in a purely digital form. The probes can therefore be disconnected from the transmitter for adjustment or servicing while the transmitter itself can remain at the measuring point.



Hint:

We recommend in this case that a probe of the same type be inserted into the transmitter immediately in order to be able to continue measuring with minimal interruption.

The transmitter identifies the probe and records that a probe was connected in the history.



The testo 6681 transmitter cannot be run with the testo 6600 probes; testo 6610 probes must be used.

2.1.1.2 The Testo humidity sensor

With the Testo humidity sensor, which has been in successful use and continually improved for more than ten years, the focus has from the very beginning been on both accuracy parameters, namely measuring uncertainty and long-term stability.

The capacitive humidity sensor is in principle a plate capacitor consisting of two electrically conductive plates (electrodes **(1)** and **(2)**, see diagram below) opposite each other.

A humidity-sensitive polymer (**5**) serves as the dielectric. The special feature lies in the perfect way the individual layers are matched to each other. This is evident particularly in the top electrode, which has to perform two tasks that, at first glance, appear contradictory: it must be completely permeable to the water vapour that is to be fed into the polymer dielectric, but at the same time it must be impervious, smooth and repellent to condensate, oil and dirt in order to protect the sensor.

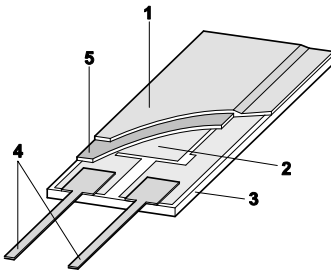

- 1 Cover electrode
- 2 Bottom electrode
- 3 Substrate
(Ceramic substrate for mechanical protection)
- 4 Connections
(protected against corrosion)
- 5 Dielectric layer



The humidity sensor cannot be exchanged by the customer. The humidity sensor may not be damaged or touched. Contamination and damage lead to an impairment of the measurement and the measuring accuracy.

2.1.1.3 Self-diagnosis

The probes in the testo 6610 range monitor their functionality themselves and report the following faults:

- Sensor breaks
- Sensor short-circuit
- Condensation
The condensation message is issued at a reading of 100 % RH and deactivated once the readings are within the valid range.
- Error message with drift at the adjustment points
- Value for relative humidity less than 0 % RH.
The trigger threshold is set at -2 % RH. This means that an error message is only issued once a clear effect is discernible.
- Early warning when sensor corrosion is starting to develop
The testo 6617 probe is able to signal the first signs of corrosion. The probe can thus be changed at an early stage without interrupting the machine availability.
- Self-adjustment (testo 6615 only)
- Excess temperature
Error message if permissible process temperature is exceeded

2.1.2 Design of the probe

The probes of the testo 6610 range are made up of the following components (included in delivery):

- Probe connector
- Probe shaft with protection cap and sensors (% RH and °C or °F)
- Mounting bracket (for testo 6612 duct version)
- Probe cable (testo 6612 to 6617, duct and cable version), bend radius minimum \varnothing 50 mm

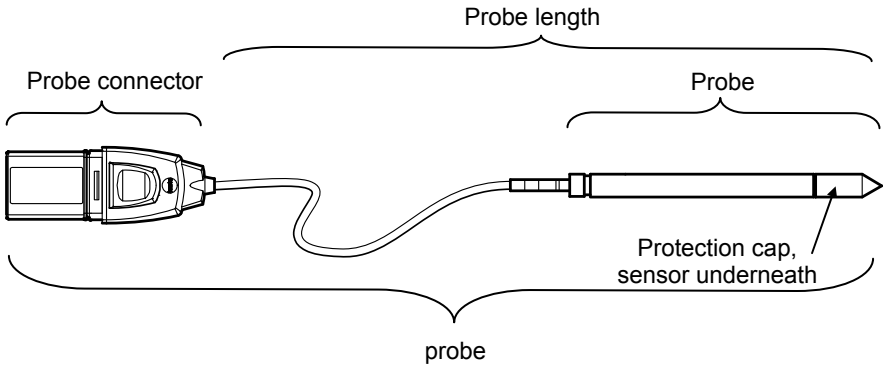

2.1.3 Accessories

The following accessories are available for probes in the testo 6610 range:

- Filters and protection caps (see *chapter 2.2.1.4, page 80*).
- Calibration certificates according to ISO and DAkkS (see *chapter 4.2, Accessories and spare parts, page 146*).

2.2 Product description

2.2.1 Overview of probe and filter types

2.2.1.1 Probe version



A detailed description of the probe versions can be found from *chapter 2.2.2, page 81* onwards.

The following probe versions are available for the testo 6681 humidity transmitter:

Version	Article no.	Characteristic
testo 6611	0555 6610-L11	Wall probe version; accuracy to ± 1 % RH; temperature range -20 °C to $+70$ °C/ -4 to $+158$ °F, sensor plugged
testo 6612	0555 6610-L12	Duct probe version; accuracy to ± 1 % RH; temperature range -30 °C to $+150$ °C/ -22 to $+302$ °F, sensor soldered/optionally plugged

Version	Article no.	Characteristic
testo 6613	0555 6610-L13	Cable probe version; accuracy to ± 1 % RH; temperature range -40 °C to $+180$ °C/ -40 to $+356$ °F, sensor soldered/optionally plugged
testo 6614	0555 6610-L14	Heated cable probe version; accuracy to ± 1 % RH; temperature range -40 °C to $+180$ °C/ -40 to $+356$ °F, sensor soldered
testo 6615	0555 6610-L15	Trace humidity cable probe version; accuracy ± 6 K at -60 °Ctd; temperature range -40 °C to $+120$ °C/ -40 to $+248$ °F, sensor soldered
testo 6617	0555 6610-L17	Cable with cover electrode monitoring probe version; accuracy ± 1.2 % RH; temperature range -40 °C to $+180$ °C/ -40 to $+356$ °F, sensor soldered

2.2.1.2 Determining the accuracy/measuring uncertainty

The entries for the measuring uncertainty for the probe are determined in accordance with GUM (Guide to the Expression of Uncertainty in Measurement/DIN V ENV 13005). All parts that make up the measuring uncertainty given by Testo are listed below. When comparing the measuring uncertainty/accuracy between manufacturers, which components are included is to be taken into account. In many cases, not all elements that contribute to measuring uncertainty are assessed, for example if the error contribution of the production adjustment is shown separately or not at all.

The measuring uncertainty of the probe includes the sensor and its electronics as well as the output of the digital measuring signal:

- 1. Linearity including scatter** Systematic error and scattering of the components (due to manufacturing tolerances)

- 2. Hysteresis** Hysteresis indicates the maximum deviation of the readings that are obtained when you set the same value for the parameter, once coming from a smaller value, once coming from a larger value (humidity sensors actually have no hysteresis, but rather very slow adjustment effects that appear to be hysteresis when considered only for a short period.)

- 3. Reproducibility** Repeatability (scattering of the readings in the event of the same parameter being entered successively)

- 4. Production adjustment area** The measuring uncertainty of the reference instruments of the adjustment area (including the reference instrument) in production

- 5. Uncertainty of the testing** Uncertainty of the procedure for determining points 1 and 2.

2.2.1.3 Ordering options for testo 6610 probes (0555 6610)

Order code	Characteristic
Lxx Probe type	
L 11	Probe 6611
L 12	Probe 6612
L 13	Probe 6613
L 14	Probe 6614
L 15	Probe 6615
L 17	Probe 6617
Mxx Protective filter	
M 01	Stainless steel sintered filter
M 02	Metal wire protection cap
M 03	Sintered PTFE filter
M 04	Open metal protection cap
M 05	ABS plastic cap (open)
M 06	PTFE filter with drip hole
M 07	PTFE filter with drip hole and condensation protector
M 08	Filter for H ₂ O ₂ atmospheres
Nxx Cable length	
N 00	Without cable (testo 6611)
N 01	1 m cable length (testo 6613, 6614, 6615, 6617)
N 02	2 m cable length (testo 6613, 6614, 6615, 6617)
N 05	5 m cable length (testo 6613, 6614, 6615, 6617)
N 10	10 m cable length (testo 6613, 6614, 6615, 6617)
Pxx Probe length	
P 07	Probe length approx. 70 mm (testo 6611)
P 12	Probe length approx. 120 mm (testo 6613)
P 20	Probe length approx. 200 mm (testo 6611, 6612, 6613, 6614, 6615, 6617)
P 30	Probe length approx. 300 mm (testo 6612, 6613, 6614)
P 50	Probe length approx. 500 mm (testo 6612, 6613, 6614, 6615, 6617)
P 80	Probe length approx. 800 mm (testo 6612, 6613)

2.2.1.4 Filters

One of the following filters or protection caps can be used for each probe version:

Filter*	Article no.**	Characteristic	Length A (mm)
M 01	0554 0647	Stainless steel sintered filter	33
M 02	0554 0757	Metal wire protection cap	40,3
M 03	0554 0759	Sintered PTFE filter	35
M 04	0554 0755	Open metal protection cap	35
M 05	0192 0265	Open ABS plastic cap	25
M 06	0554 9913	PTFE filter with drip hole	35
M 07	0554 9913 + 0554 0166	PTFE filter with drip hole and condensation protector	35 55
M 08	0554 6000	Filter for H ₂ O ₂ atmospheres	35

* When ordering the probe, please use this filter code, cf. *chapter 2.2.1.3, Ordering options for testo 6610 probes (0555 6610), page 79.*

** When purchasing a replacement (filters only), please use this order number

2.2.2 testo 6611 wall probe

The wireless testo 6611 probe is inserted into the testo 6681 humidity transmitter that is mounted on the wall and ready-wired.

At a glance

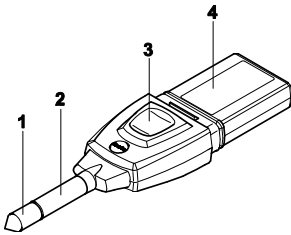

- 1 Filter (including: humidity and temperature sensor)
- 2 Probe shaft
- 3 Key
- 4 Connector

Application

- Monitoring and regulating the production and storage air quality when manufacturing and storing hygroscopic products
- Meeting the top accuracy requirements
- Clean room applications for which a metal housing is required.

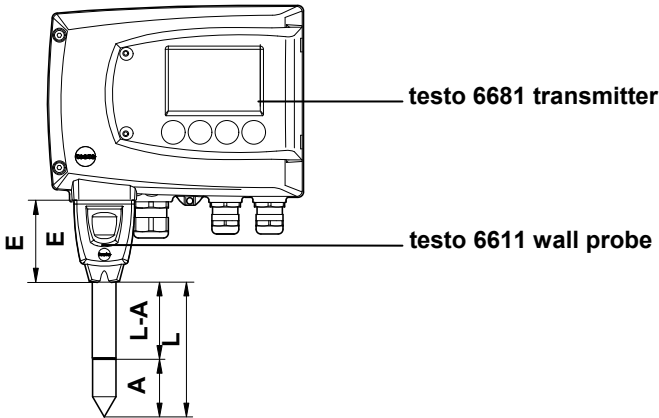

Technical Data

Parameters

- Humidity (% °Ctd/°Ftd), etc.
- Temperature

Measuring range

- Humidity: 0 to 100 % RH
- Temperature: -20 to +70 °C/4 to +158 °F

Material

- Probe shaft: Stainless steel
- Connector: ABS plastic

Accuracy (at 25 °C/77 °F)*

Length 200 mm

Humidity

- $\pm (1,0 \% \text{ RH} + 0.007 \times \text{reading})$ for 0 to 90 % RH
- $\pm (1,4 \% \text{ RH} + 0.007 \times \text{reading})$ for 90 to 100 % RH
- 0.02 % RH/K, dependent upon the process temperature (with a deviation of 25 °C/+77 °F)
- 0.02 % RH/K, dependent upon the electronics temperature (with a deviation of 25 °C/+77 °F)

Temperature

- $\pm 0.15 \text{ °C}$ (0.27 °F)

with slope PT1000 class AA

- * Refer to the charts below for the correlation between temperature and accuracy.

Length 70 mm

As with length of 200 mm, but with additional measuring error, specified for the operating mode 2 channels at 12 mA, without display light, relay off:

Humidity: $\pm 1.6 \% \text{ RH}$ (additional)

Temperature: $\pm 0.6 \text{ °C}$ / $\pm 1.1 \text{ °F}$ (additional)

Reproducibility

- Better than $\pm 0,2 \% \text{ RH}$

Sensor

Response time without protective filter: t_{90} max. 15 sec.

Probe dimensions

- Diameter of probe shaft: 12 mm
- E = 55 mm
- L = approx. 70 mm or 200 mm
- L – A = 35 mm or 165 mm
- A, see Table *Filters*, chapter 2.2.1.4, page 80.

Measuring accuracy of testo 6611 wall probe

Humidity error according to amount $|\pm\% \text{RH}|$ as a factor of process humidity

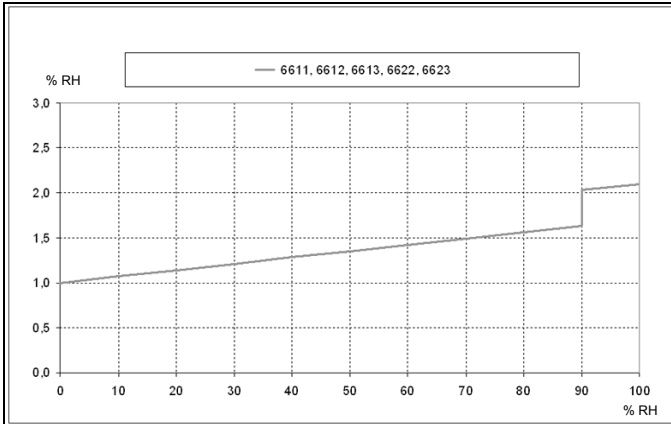

Temperature error as a factor of process temperature and temperature of electronics

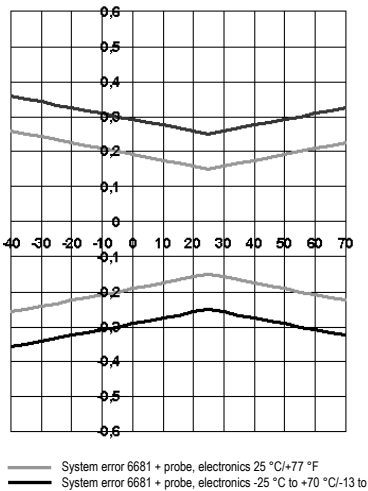

2.2.3 testo 6612 duct probe

The testo 6612 probe measures the humidity and temperature in air ducts.

At a glance

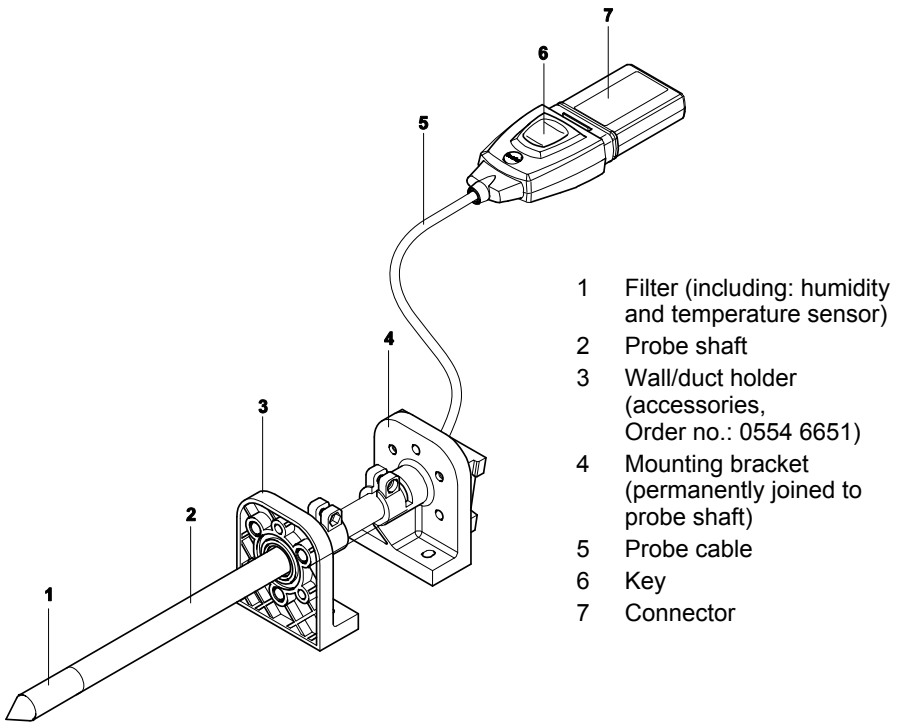

In the event of overpressures, the probe may become a projectile.

For assembly, see **Pressure resistance** on the following page.

Application

- Monitoring and regulating the production and storage air quality in air ducts when manufacturing and storing hygroscopic products
- Meeting the top accuracy requirements
- Air duct applications for which a metal housing is required.

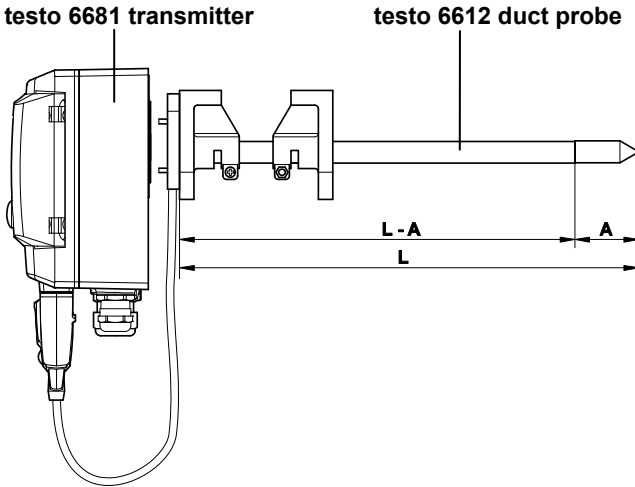

Technical Data

Parameters

- Humidity (% RH/°Ctd/°Ftd), etc.
- Temperature

Measuring range

- Humidity: 0 to 100 % RH
- Temperature: - 30 to +150 °C/-22 to +302 °F

Material

- Probe shaft: Stainless steel
- Line: Sheathed, FEP
- Connector: ABS plastic

Accuracy (at 25°C/77°F)*

Humidity

- $\pm (1,0 \% \text{ RH} + 0.007 \times \text{reading})$ for 0 to 90 % RH
- $\pm (1,4 \% \text{ RH} + 0.007 \times \text{reading})$ for 90 to 100 % RH

- 0.02 % RH/K, dependent upon the process temperature (with a deviation of 25 °C/+77 °F)
- 0.02 % RH/K, dependent upon the electronics temperature (with a deviation of 25 °C/+77 °F)

Temperature

- $\pm 0.15 \text{ °C}$ (0.27 °F)

Slope PT1000 class AA

* Refer to the charts below for the correlation between temperature and accuracy.

Reproducibility

- Better than $\pm 0,2 \% \text{ RH}$

Sensor

Response time without protective filter: t_{90} max. 15 sec.

Probe dimensions

- Diameter of probe shaft: 12 mm
- L = approx. 200/300/500/800 mm
- L – A = 165/265/465/765 mm
- A, see Table *Filters, chapter 2.2.1.4, page 80.*

Cable length incl. probe shaft and filter

- Customized for duct version

Pressure resistance

- PN 10 (probe tip)**
- ** If installing probe under pressure, please use cutting ring screw connection (order no. 0554 1795).

Measuring accuracy of testo 6612 duct probe

Humidity error according to amount $|\pm\% \text{ RH}|$ as a factor of process humidity

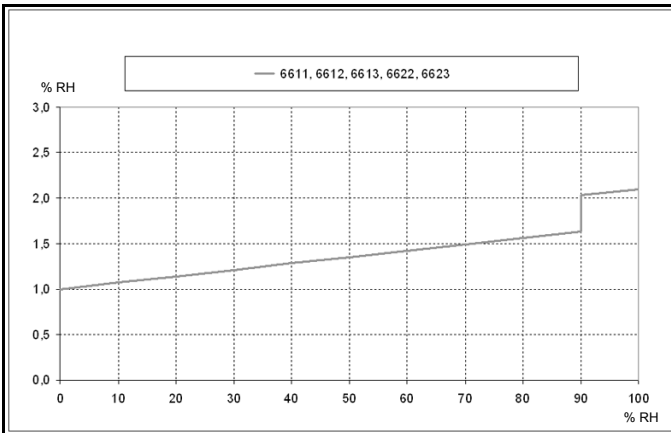

Temperature error as a factor of process temperature and temperature of electronics

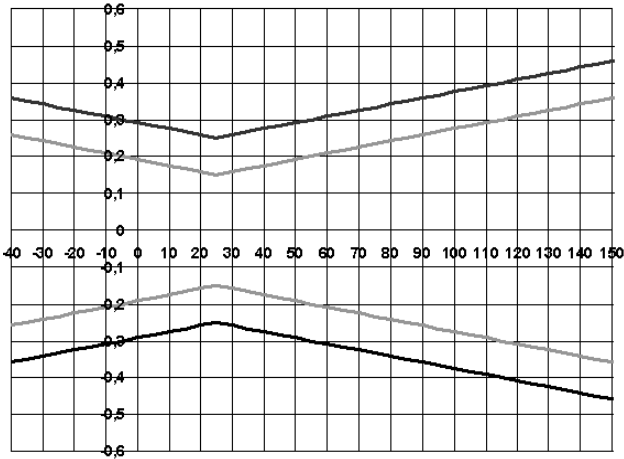

— System error 6681 + probe, electronics 25 °C/+77 °F
 — System error 6681 + probe, electronics -25 °C to +70 °C/-13 to +158 °F

2.2.4 testo 6613 cable probe

The testo 6613 probe is used when the spatial separation of the transmitter and probe is required.

At a glance

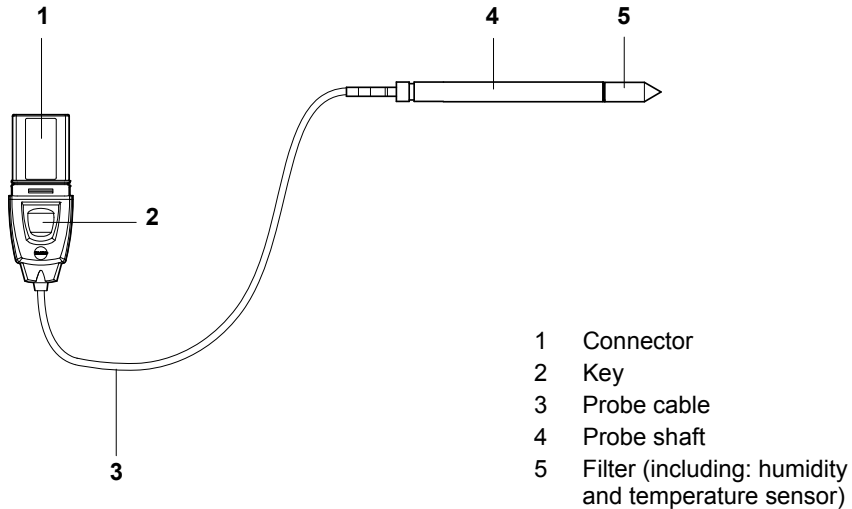

In the event of overpressures, the probe may become a projectile.

For assembly, see **Pressure resistance** on the following page.

Application

- Monitoring and regulating industrial humidity processes (apart from high-humidity processes), e.g. food production, storing fruit
- Monitoring the production and storage air quality when manufacturing and storing hygroscopic products
- Meeting the top accuracy requirements
- Clean room applications
- Applications for which a sturdy metal housing is required.



We recommend that the testo 6614 (heated) probe be used for continuous high-humidity processes.

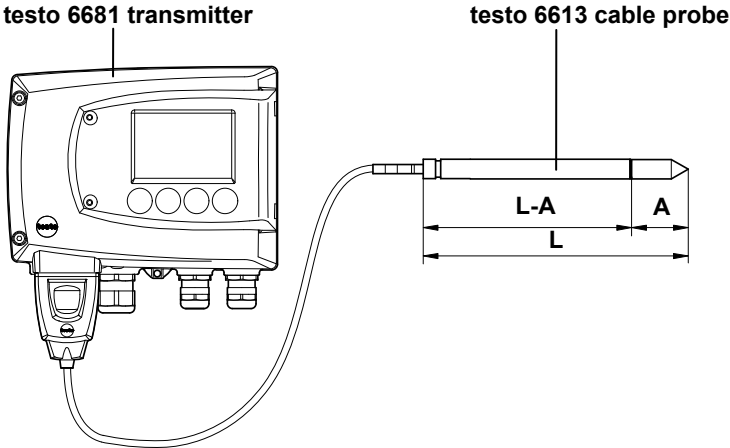

Technical Data

Parameters

- Humidity (% RH/°Ctd/°Ftd), etc.
- Temperature

Measuring range

- Humidity: 0 to 100 % RH
- Temperature: - 40 to *180 °C/-40 to +356 °F

Material

- Probe shaft: Stainless steel
- Line: Sheathed, FEP
- Connector: ABS plastic

Accuracy (at 25 °C/77 °F)*

Humidity

- $\pm (1,0 \% \text{ RH} + 0.007 \times \text{reading})$ for 0 to 90 % RH
- $\pm (1,4 \% \text{ RH} + 0.007 \times \text{reading})$ for 90 to 100 % RH
- 0.02 % RH/K, dependent upon the process temperature (with a deviation of 25 °C/+77 °F)

- 0.02 % RH/K, dependent upon the electronics temperature (with a deviation of 25 °C/+77 °F)

Temperature

- $\pm 0.15 \text{ °C} (0.27 \text{ °F})$

Slope PT1000 class AA

- * Refer to the charts below for the correlation between temperature and accuracy.

Reproducibility

- Better than $\pm 0,2 \% \text{ RH}$

Sensor

Response time without protective filter: t_{90} max. 15 sec.

Probe dimensions

- Diameter of probe shaft: 12 mm
- L = approx. 120/200/300/500/800 mm
- L – A = 85/165/265/465/765 mm
- A, see Table *Filters*, chapter 2.2.1.4, page 80.

Probe length incl. probe shaft and filter

- 1/2/5/10 m

Pressure resistance**

- PN 10 (probe tip)
 - PN 1 (if end of probe/cable is involved in process)
- ** If installing probe under pressure, please use cutting ring screw connection (order no. 0554 1795).

Measuring accuracy of testo 6613 cable probe

Humidity error according to amount $|\pm\% \text{ RH}|$ as a factor of process humidity

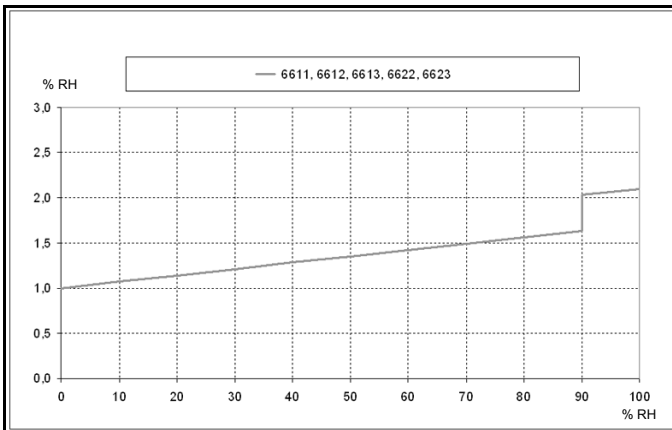

Temperature error as a factor of process temperature and temperature of electronics

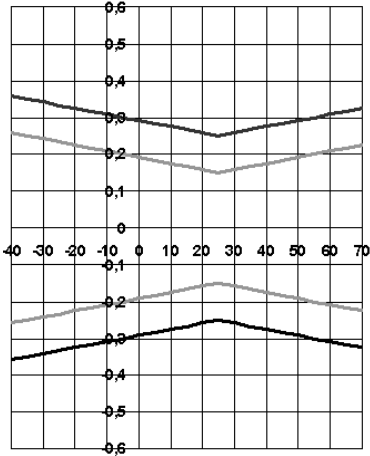

— System error 6681 + probe, electronics 25 °C/+77 °F
 — System error 6681 + probe, electronics -25 °C to +70 °C/-13 to +158 °F

2.2.5 testo 6614 heated cable probe

The testo 6614 heatable probe is suitable for use in high-humidity processes in which there is the possibility of condensation for the probe.



Please also see *volume 1, chapter 1.3.3.5, page 39*, for the functional principle of the testo 6614.

At a glance

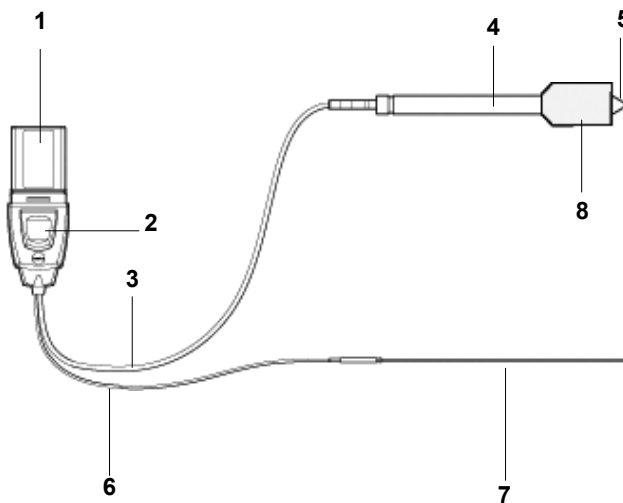

- 1 Connector
- 2 Key
- 3 Probe cable
- 4 Probe shaft
- 5 Filter (including:
humidity and
temperature sensor)
- 6 Cable for temperature
probe
- 7 Temperature probe
- 8 Condensation protection
(0554 0166/
0554 0117)



In the event of overpressures, the probe may become a projectile.

For assembly, see **Pressure resistance** on the following page.

Application

- Monitoring and regulating high-humidity processes, e.g. drying (ceramics, tobacco, wood, food) and maturing (cheese, fruit).
- At flow velocities > 1 m/s, an additional measuring uncertainty, not higher than +1.5 % RH, is to be expected. To prevent this error and ensure the highest measuring accuracy: Use condensation protector 0554 0166.

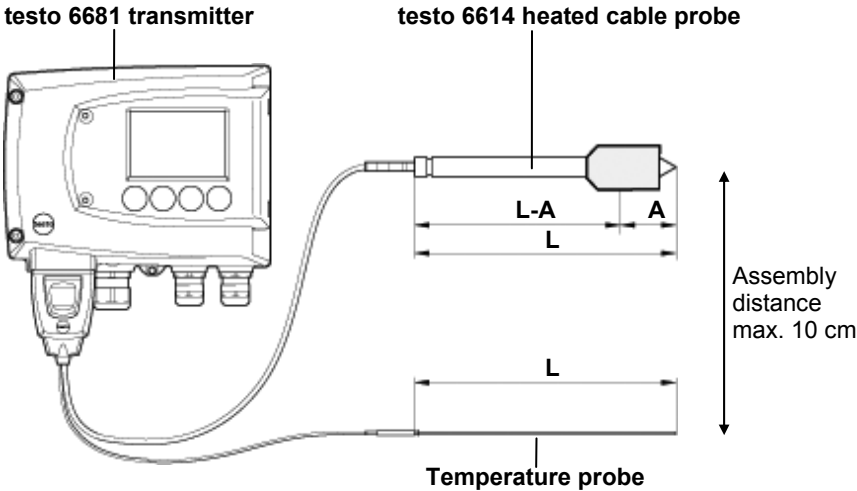

Technical Data

Parameters

- Humidity (% RH/°Ctd/°Ftd), etc.
- Temperature

Measuring range

- Humidity: 0 to 100 % RH
- Temperature: - 40 to +180 °C/-40 to +356 °F

Material

- Probe shaft: Stainless steel
- Line: Sheathed, FEP
- Connector: ABS plastic

Accuracy (at 25 °C/77 °F)*

Humidity

- $\pm (1.0 \% \text{ RH} + 0.007 \times \text{reading})$ for 0 to 100 % RH

- 0.02 % RH/K, dependent upon the process temperature (with a deviation of 25 °C/+77 °F)
- 0.02 % RH/K, dependent upon the electronics temperature (with a deviation of 25 °C/+77 °F)

Temperature

- $\pm 0.15 \text{ °C} (0.27 \text{ °F})$
- Slope PT1000 class AA
- * Refer to the charts below for the correlation between temperature and accuracy.

Reproducibility

- Better than $\pm 0,2 \% \text{ RH}$

Sensor

Response time without protective filter: t 90 max. 15 sec.

Probe dimensions

- Diameter of probe shaft: 12 mm
- Diameter of temp. probe: 3 mm
- L = approx. 200/500 mm
- L – A = 165/465 mm
- A, see Table *Filters, chapter 2.2.1.4, page 80.*

Probe length incl. probe shaft and filter

- 1/2/5/10 m

Pressure resistance**

- PN 10 (probe tip)
- PN 1 (if end of probe/cable is involved in process)

** If installing probe under pressure, please use cutting ring screw connection (order no. 0554 1795).

Measuring accuracy of testo 6614 heated cable probe

Humidity error according to amount $|\pm\% \text{ RH}|$ as a factor of process humidity

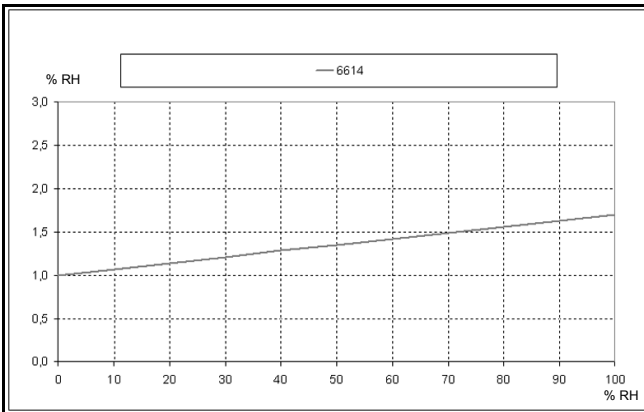

Temperature error as a factor of process temperature and temperature of electronics

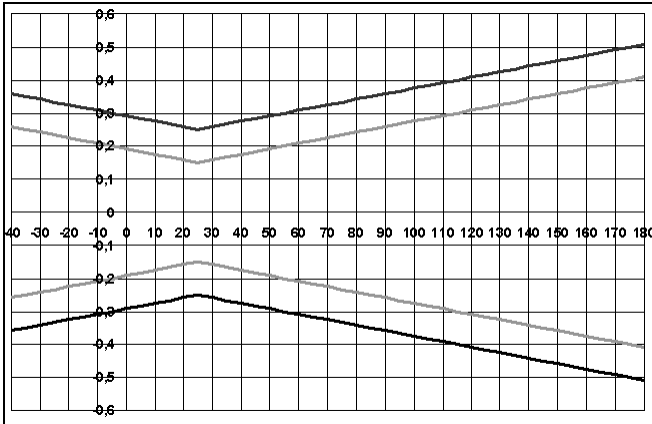

— System error 6681 + probe, electronics 25 °C/+77 °F
 — System error 6681 + probe, electronics -25 °C to +70 °C/-13 to +158 °F

2.2.6 testo 6615 trace humidity cable probe (self-adjustment)

The testo 6615 probe corrects deviations in measurements by means of self-adjustment. This has a particular significance with low humidity values (in dewpoint range).



Please also see *volume 1, chapter 1.3.3.6, page 40* for the functional principle of the testo 6615.

Only use testo 6615 with sintered PTFE filter (art. no. 0554 0759) or sintered stainless steel filter (art. no. 0554 0647).

During the self-adjustment phase the signal values of the analog outputs remain on hold, meaning they are frozen for the duration.

At a glance

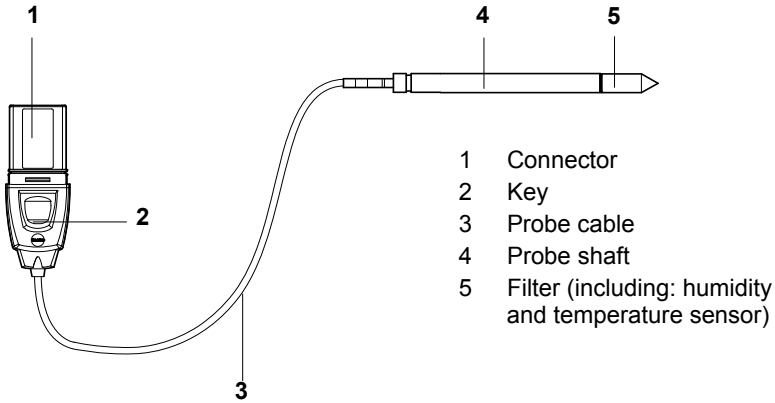

In the event of overpressures, the probe may become a projectile.

For assembly, see **Pressure resistance** on the following page.

Application

- Monitoring and regulating trace humidity processes (compressed air with adsorption or membrane driers and plastic granulate driers)
- Used when spatial separation of transmitter and probe is required.

testo 6681 transmitter

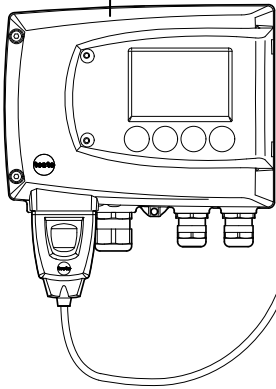

testo 6615 trace humidity cable probe

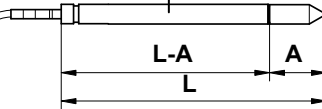

Technical Data

Parameters

- Dewpoint (°Ctd/°Ftd), etc.
- Temperature

Measuring range

- Dewpoint: - 60 to + 30 °Ctd/-148 to +212 °Ftd
- Temperature: - 40 to +120 °C -40 to +248 °F

(Temp. durability up to +180 °C/+356 °F)

Material

- Probe shaft: Stainless steel
- Line: Sheathed, FEP
- Connector: ABS plastic

Accuracy (at 25 °C/77 °F)*

Dewpoint

- ± 1 K at 0 °Ctd/+32 ° Ftd
- ± 2 K at -40 °Ctd/- 40 ° Ftd
- ± 4 K at -50 °Ctd/-58 ° Ftd
- ± 6 K at -60 °Ctd/-76 ° Ftd

Dependency on process temperature
(Deviation from 25 °C/77 °F)

- ± 0,1 Ktf/K at -40 °C...25 °C/
-40 °F...+77 °F

- ± 0,2 Ktf/K at 25 °C...50 °C/
77 °F...+122 °F
- ± 0,4 Ktf/K at 50 °C...120 °C/
+122 °F...+248 °F

Temperature

- ±0.15 °C (0.27 °F)

Slope PT100 class AA

* Refer to the charts below for the correlation between temperature and accuracy.

Reproducibility

- Better than ±0,2 % RH

Sensor

Response time without protective filter: t 90 max. 15 sec.

Probe dimensions

- Diameter of probe shaft: 12 mm
- L = approx. 200/500 mm
- L – A = 165/465 mm
- A, see Table *Filters, chapter 2.2.1.4, page 80.*

Probe length incl. probe shaft and filter

- 1/2/5/10 m

Pressure resistance

- PN 16 (probe tip)**

** If installing probe under pressure, please use cutting ring screw connection (order no. 0554 1795).

Measuring accuracy of testo 6615 trace humidity cable probe

Dewpoint error numerically $|\pm\%RH|$ dependent on the process dewpoint

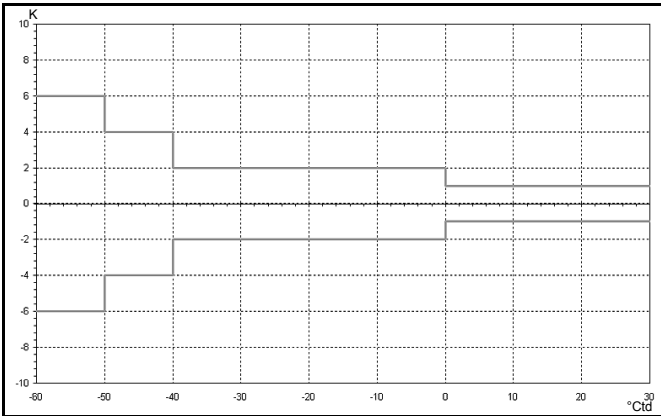

Temperature error as a factor of process temperature and temperature of electronics

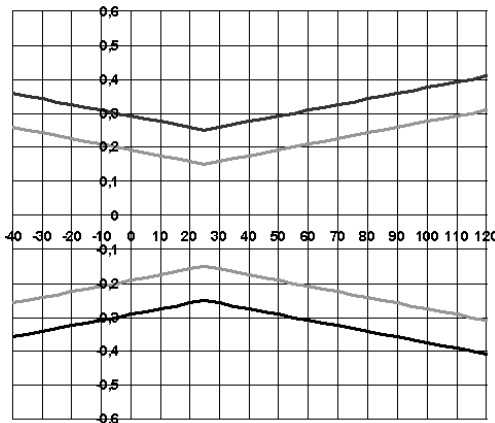

— System error 6681 + probe, electronics 25 °C/+77 °F
 - - - System error 6681 + probe, electronics -25 °C to +70 °C/-13 to +158 °F

2.2.7 testo 6617 cable probe (self-monitoring)

The testo 6617 probe is used if spatial separation of the transmitter and probe is required, particularly for media (gases, vapours) which can jeopardize/damage the humidity sensor (the testo 6617 has a self-monitoring and early-warning function for such applications).

At a glance

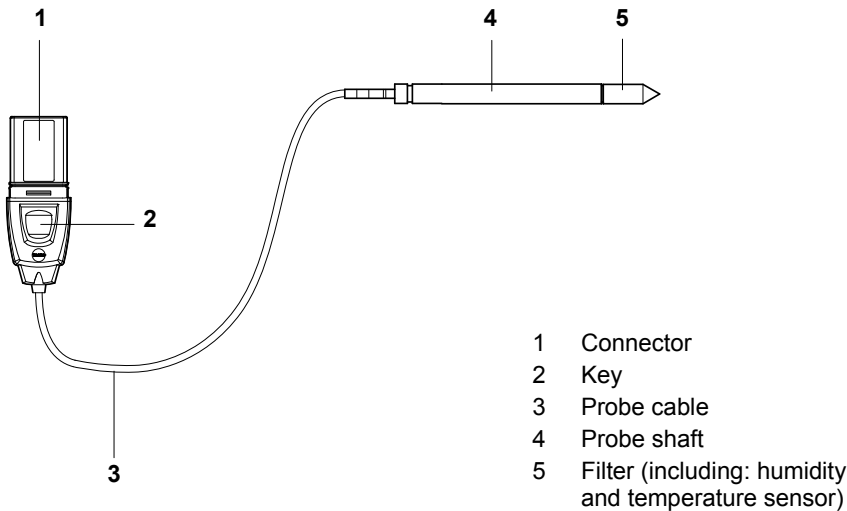

In the event of overpressures, the probe may become a projectile.

For assembly, see **Pressure resistance** on the following page.

Application

- Monitoring and regulating industrial humidity processes involving corrosive media (apart from high-humidity processes) with the exception of applications with HCL, HF and other acids and acidifiers in larger concentrations (SO₂, SO₃, NO₂)
- Meeting the top accuracy requirements
- Applications for which a sturdy metal housing is required.



This probe does NOT have a longer life with exposure to aggressive media than the testo 6613, for example. However, early warning of damage to the sensor is given so that machine failures can be avoided.

2.2.7.1 Self-monitoring of cover electrode

Use in harsh ambient conditions with aggressive media in some cases incurs the risk of damage to the sensor.

Damage to the sensor is generally reflected by incorrect readings which occur a long time before the sensor is wrecked. If this damage to the sensor is not spotted until too late, high costs can be incurred due to unusable readings or machine shutdowns and waiting times until the sensor is replaced.

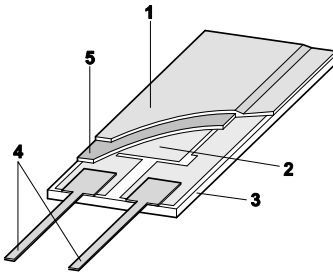

- 1 Cover electrode
- 2 Bottom electrode
- 3 Substrate
(Ceramic substrate for mechanical protection)
- 4 Connections
(protected against corrosion)
- 5 Dielectric layer

The testo 6617 has a unique self-monitoring function. This allows early detection of damage to the sensor, e.g.:

- Mechanical damage (e.g. scratches)
- Damage from aggressive gases (e.g. acids in aerosol form)
- Welling or detachment of polymer layer due to effects of solvents.

Once the self-monitoring reaches the specific limit value, the probe warning message "Sensor early warning" is issued.

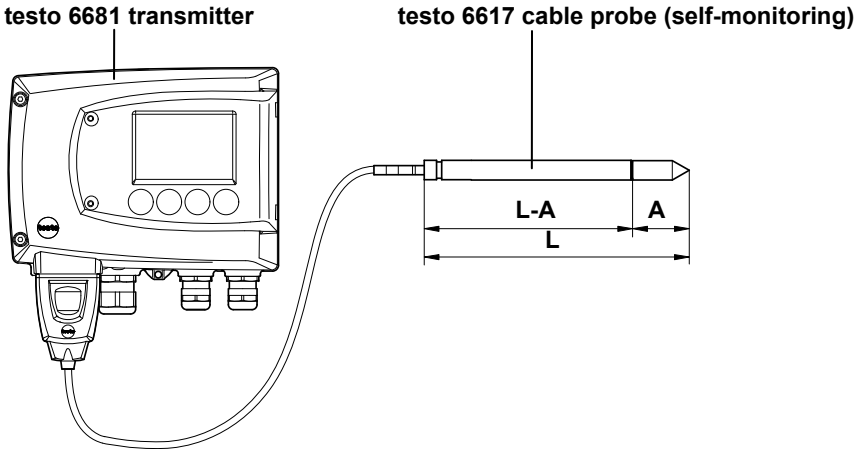

Technical Data

Parameters

- Humidity (% RH/°Ctd/°Ftd)
- Temperature

Measuring range

- Humidity: 0 to 100 % RH
- Temperature: - 40 to + 180 °C/-40 to 356 °F

Material, weight

- Probe shaft: Stainless steel
- Line: Sheathed, FEP
- Connector: ABS plastic

Accuracy (at 25 °C/77 °F)*

Humidity

- $\pm (1,2 \% \text{ RH} + 0.007 \times \text{reading})$ for 0 to 90 % RH
- $\pm (1,6 \% \text{ RH} + 0.007 \times \text{reading})$ for 90 to 100 % RH
- 0.02 % RH/K, dependent upon the process temperature (with a deviation of 25 °C/+77 °F)
- 0.02 % RH/K, dependent upon the electronics temperature (with a deviation of 25 °C/+77 °F)

Temperature

- $\pm 0.15 \text{ °C} (0.27 \text{ °F})$

Slope PT1000 class AA

* Refer to the charts below for the correlation between temperature and accuracy.

Reproducibility

- Better than $\pm 0,2 \% \text{ RH}$

Sensor

Response time without protective filter: t 90 max. 15 sec.

Probe dimensions

- Diameter of probe shaft: 12 mm
- L = approx. 200/500 mm
- L – A = 165/465 mm
- A, see Table *Filters*, chapter 2.2.1.4, page 80.

Probe length incl. probe shaft and filter

- 1/2/5/10 m

Pressure resistance

- PN 10 (probe tip)**

** If installing probe under pressure, please use cutting ring screw connection (order no. 0554 1795).

Measuring accuracy of testo 6617 cable probe (self-monitoring)

Humidity error according to amount $|\pm\% \text{ RH}|$ as a factor of process humidity

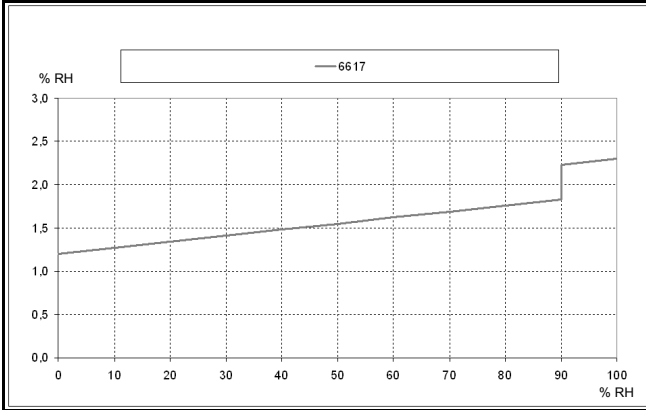

Temperature error as a factor of process temperature and temperature of electronics

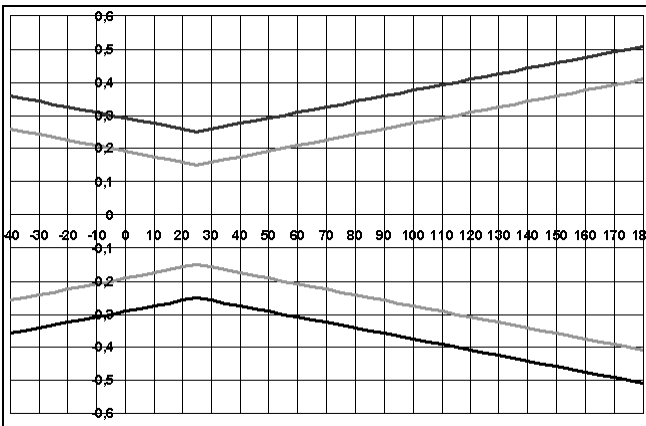

— System error 6681 + probe, electronics 25 °C/+77 °F
 — System error 6681 + probe, electronics -25 °C to +70 °C/-13 to +158 °F

2.3 Commissioning

2.3.1 Installing the probe

2.3.1.1 Installing the testo 6611 wall probe

The testo 6611 probe (wall version) simply has to be inserted into the socket of the testo 6681 transmitter.

2.3.1.2 Installing the testo 6612 duct probe

A description of the duct mounting of the testo 6612 probe can be found in *volume 1, chapter 1.3.1.2, page 18*.

2.3.1.3 Installing testo 6613/6614/6615/6617 probes

If used with these probes, the testo 6681 transmitter is mounted on the wall, see *volume 1, chapter 1.3.1.1, page 16*.

Install probe according to the application and the measuring and spatial conditions, cf. cases A1 to C below



In processes with which condensate forms at the humidity probe, install the probe vertically (filter points downwards).

A 1 Wall mounting of probe

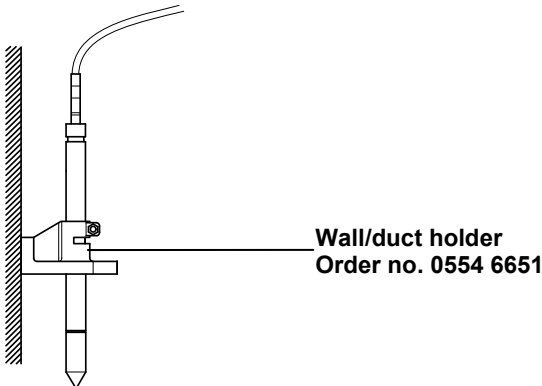

A 2 Wall mounting of testo 6614 heated probe

When mounting the testo 6614 heated probe version, the temperature probe must be secured as close to the humidity probe as possible (max. 10 cm). An appropriate assembly tool is supplied with the testo 6614.

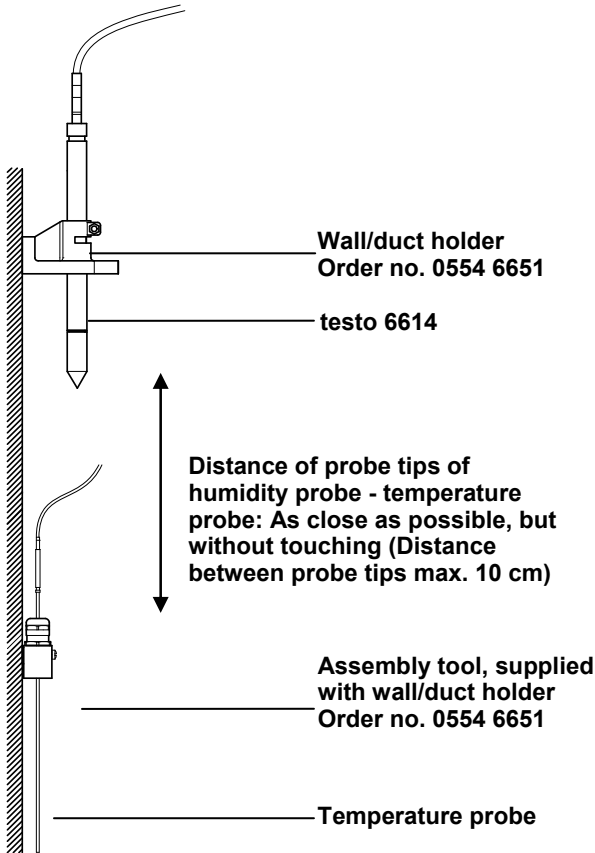

B 1 Duct mounting of probe

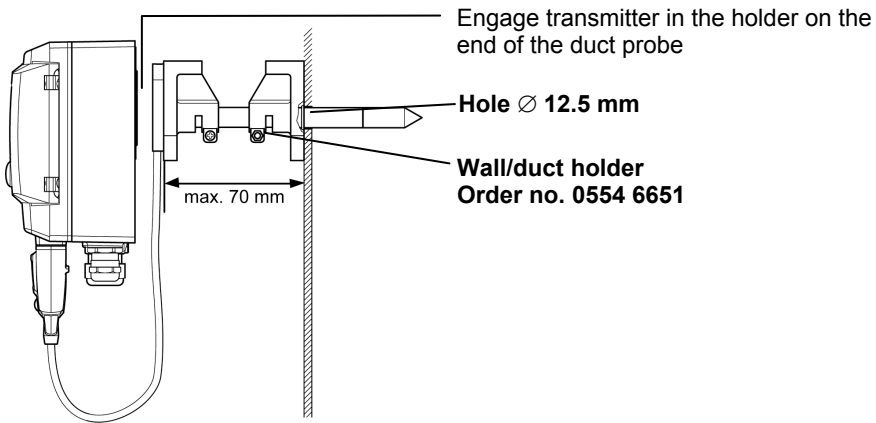

Only atmospheric processes up to approx. 1 bar positive pressure.
Alternatively, the single-hole duct holder (order no. 0554 1793) can also be used.

B 2 Duct mounting of testo 6614 heated probe

When mounting the testo 6614 heated probe version, the temperature probe must also be secured at a distance of approximately 10 cm from the humidity probe. An appropriate assembly tool is supplied with the testo 6614.

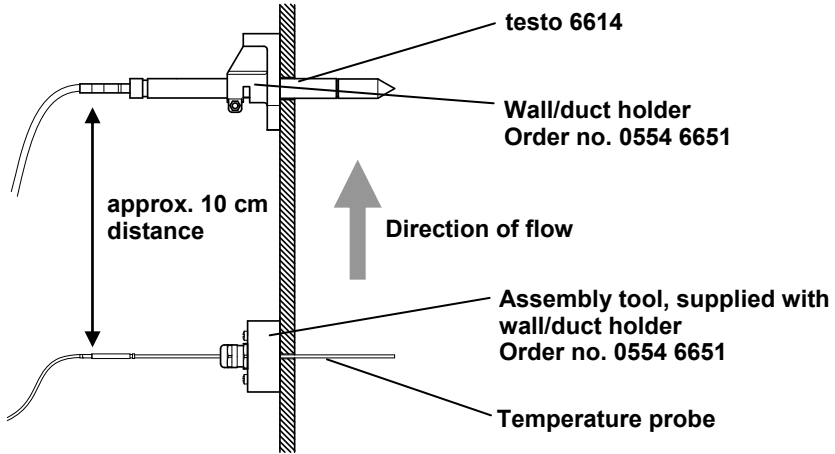

C Process mounting

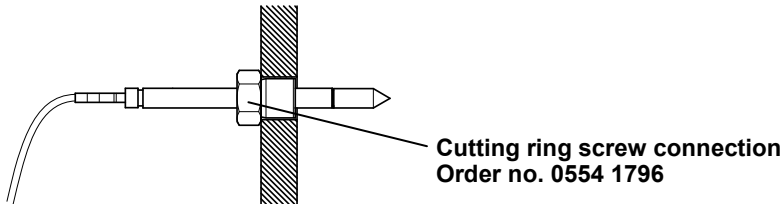

- During installation, ensure that the probe cannot be damaged during operation.



For the testo 6614 (heated probe version), please use the cutting ring screw connection, order no. 0400 6193, to assemble the temperature probe.

2.3.2 Connecting/removing the probe to/from the transmitter

- Insert probe connector into socket of testo 6681 until it engages. The testo 6681 identifies which probe is connected.
- To remove the probe, the lock release button on the probe must be pressed so that this can be removed.

2.4 Maintenance and cleaning

2.4.1 Replacing filters/protection caps

2.4.1.1 Replacing the filter/protection cap for testo 6611 wall version

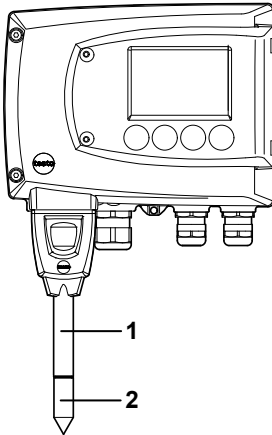

Do not damage the sensors when exchanging the filter/the protection cap and do not touch their surfaces!

- 1 Unscrew defective filter/protection cap **(2)** from probe shaft **(1)**.
- 2 Screw new filter/protection cap onto probe shaft.



Screw on protection cap by hand, i.e. do not tighten it using a tool.



Screw on protection cap by hand, i.e. do not tighten it using a tool.

- 3 Replace O-ring **(6)** if necessary. Push probe shaft into duct as far as the marking and fix position with screw **(9)**.

2.4.1.3 Replacing the filter/protection cap for cable versions



The following descriptions applies to these probes:

- testo 6613
- testo 6614
- testo 6615
- testo 6617

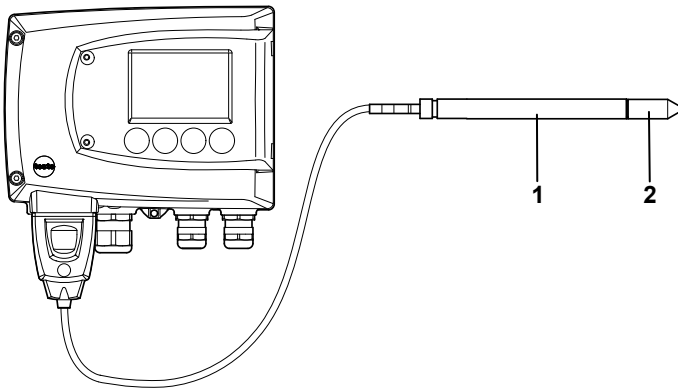

Do not damage the sensor when exchanging the filter/the protection cap and do not touch its surface!

- 1 Unscrew defective filter/protection cap **(2)** from probe shaft **(1)**.
- 2 Screw new filter/protection cap onto probe shaft.



Screw on protection cap by hand, i.e. do not tighten it using a tool.

2.4.2 Cleaning the instrument and filter/protection cap

- Only clean the instrument carefully with a moist cloth.
- Do not use aggressive cleaning agents.
- Do not use any solvents.
- Unscrew cap or protection cap to clean, clean with compressed air and replace. Take care not to damage the sensor!

2.4.3 Replacing the sensor

Thanks to the probe concept (digital, plug-in), all probes can be changed in situ within seconds if necessary, generally without any interruption to the operation of the machine.



To maintain the extremely high accuracy of the testo 6610 probe, customers are not able to replace the sensor.

Please contact your Testo Service team for this.

3 Parameterizing, adjusting and analyzing software (P2A software)

3.1 Specifications

The P2A software is used for the parameterizing, adjustment and analysis of testo transmitters. The following applies:

- Generally, all newer testo transmitters (as of 2007) are supported.
- Included with every testo transmitter that is bought new is a CD that contains a free upgrade of the software, which includes the device drivers for all transmitters that can be attached at this time.
- This upgrade can be downloaded at any time via the testo homepage "www.testo.com/Download/P2A".

The software must only be bought one time, even for owners of several testo transmitters.

3.1.1 Functions and use

In the P2A software, two different file types are used: The instrument and the parameter file.

Instrument file

The parameters of a particular transmitter are stored in its so-called instrument file. Using this file, the parameters can be edited and the instrument can be tested and adjusted.

Instrument files also contain the respective histories in addition to the parameter data, i.e. "log books" are kept for the previous parameterizations, adjustments and messages (see *chapter 3.3.5, page 139*).



Instrument files are ".cfm" format files.

Parameter file

Parameter files are not tied to a specific individual transmitter and contain only parameter data/no history data.

If you use various instruments of the same type, you can create parameter files once (e.g. by saving the appropriate instrument file as the parameter file) and transmit these onto the other instruments.



Parameter files are ".cfp" format files.

3.1.2 System requirements

Operating system

- Windows® 2000 SP4
- Windows® XP Home/Professional
- Vista

Computer

- Pentium processor of at least 400 MHz or equivalent
- 128 MB RAM
- Graphics resolution of at least 1,024 x 768
- Unused hard drive capacity of at least 15 MB
- CD-ROM drive
- USB interface
- At least Internet Explorer 5.0.

Software

The P2A software must be purchased and installed separately from the transmitter. If it is a new software version, the transmitter is already supported completely. Older P2A software versions can be updated via the P2A software upgrade (cf. product CD included with the transmitter).

3.1.3 Scope of delivery

Included in the scope of delivery are:

- P2A software
- USB driver



When working with the parameterizing, adjusting and analyzing software (P2A software), previous knowledge of Windows[®] operating systems is assumed.

The description in this instruction manual relates to Windows[®] XP.

3.2 First steps

3.2.1 Installing the software/driver



Administrator rights are required to install programs and drivers under Windows[®] 2000 SP4, XP and Vista.

3.2.1.1 Installing P2A software

- 1 Insert CD with P2A software. If the installation program does not start automatically:
 - Open Windows Explorer and start the file **Setup.exe** on the product CD.
- 2 Follow the directions of the installation assistant.

3.2.1.2 Installing USB driver



Before installing the USB driver, please read the separate documentation that is enclosed with the USB driver CD.

3.2.1.3 P2A software upgrade

- 1 Insert product CD (supplied with the transmitter).
Open Windows[®] Explorer and start the file **P2A upgrade.exe** on the product CD.
- 2 Follow the directions of the installation assistant.

3.2.2 Starting the software

3.2.2.1 Starting the program

- Select: **[Start] > All Programs > Testo > P2A Software.**

The program window is opened (see *chapter 3.3.1, User interface, page 116*).

3.2.2.2 Establishing a connection with the instrument

Multiple instruments can be attached, however only one connection is active at all times.

- ✓ USB driver is installed (see *chapter 3.2.1, Installing the software/driver, page 114*).

- 1 Start the P2A software.
- 2 Connect adapter (supplied with the P2A software) to the service interface of the instrument (see *volume 1, chapter 1.2.4, Service interface, page 10*).
- 3 Connect instrument/adapter to the PC via the USB interface.

The instrument file of the attached instrument is shown in the file list.

3.2.2.3 Activating the connection with the instrument

- Click on the desired instrument file.

The selected file is marked in colour and the connection with the instrument is activated.

If a connection with the instrument is established when the program is started, the corresponding instrument file is marked automatically.

3.3 Using the software

3.3.1 User interface

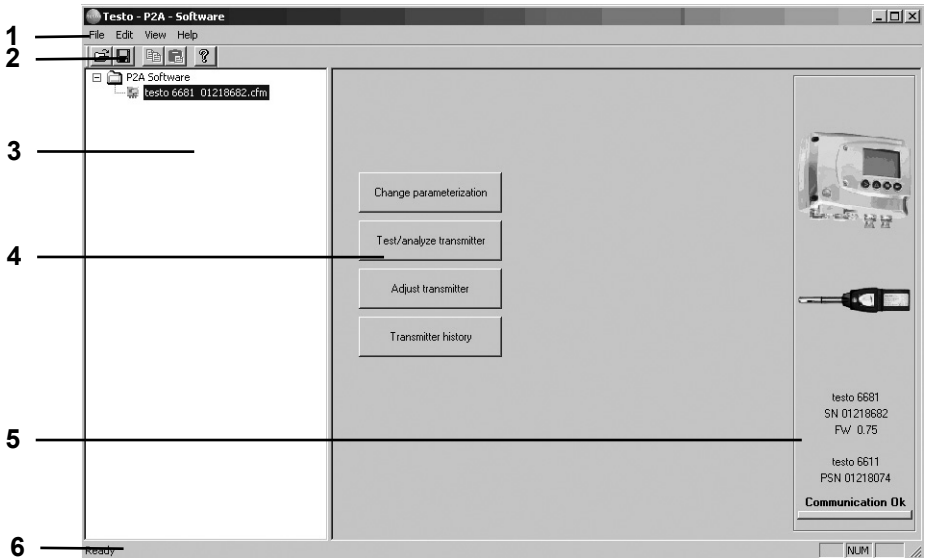



1 Menu bar:

Menu	Command	Explanation
File	Open	Shows the Windows dialogue for searching and opening files.
	Save as	Saves the parameters of an instrument or parameter file under a new name.
Edit	Copy	Copies the parameters of the marked instrument or parameter file in the cache.
	Paste	Pastes the parameters from the cache in the marked instrument or parameter file.

Menu	Command	Explanation
View	Toolbar Status bar	Activates/deactivates the toolbar or status bar.
?	Check instrument connections	Checks the connections to a connected instrument without the instrument having to be activated.
	Service	A text file with the most important information on the computer and the software is opened via Display service data .
	About	Shows the version number of the P2A software.

2 Toolbar:
Shows the Windows-compliant icons for editing.

3 File list:

Icon	File	Explanation
	Instrument file	Instrument file Connection to the instrument has been established. <Type> <Serial number>.cfm File name should not be changed.
	Instrument file	Instrument file Connection to the instrument has not been established.
	Parameter file	<Type> <Serial number> <Date> <Time>.cfp File name can be changed. The name can be selected freely, but it is recommended that you retain the reference to the instrument. Parameter files are always marked red; the parameter values they contain are only forwarded to the instrument after being transmitted to the instrument file.

4 Function buttons:

[Change parameterization] see chapter 3.3.2, page 118

[Test/analyze transmitter] see chapter 3.3.3, page 128

[Adjust transmitter] see chapter 3.3.4, page 134

[Transmitter history] see chapter 3.3.5, page 139

Dialogues on editing and testing the instrument are opened by means of the buttons.

5 File information:

Status	Shown in the window
An instrument file is selected	Type, serial number, firmware version of the instrument or probe.
A parameter file is selected	Type, serial number and firmware version of instrument for which the parameter file was created.
Connection status	Green = connection is active, Red = connection is inactive.

6 Status bar:

Shows the current status when editing via the menu bar.

3.3.2 Editing instrument/parameter file

3.3.2.1 Changing instrument/parameter file

✓ The desired instrument/parameter file is marked.

1 Click on **[Change parameterization]**.

The **Properties of <Instrument type> <Serial number>** dialogue is opened with the **Change parameterization** register.

If the parameters were transmitted from other parameter files into the instrument file, a message is shown with which you can transmit the new parameters to the connected instrument using **[Yes]**.

If the parameters should not be transmitted, click on **[No]**.

2 Change or enter parameters in the corresponding fields.

Unit/analog output

Explanation

All analog outputs are parameterized in this mask.

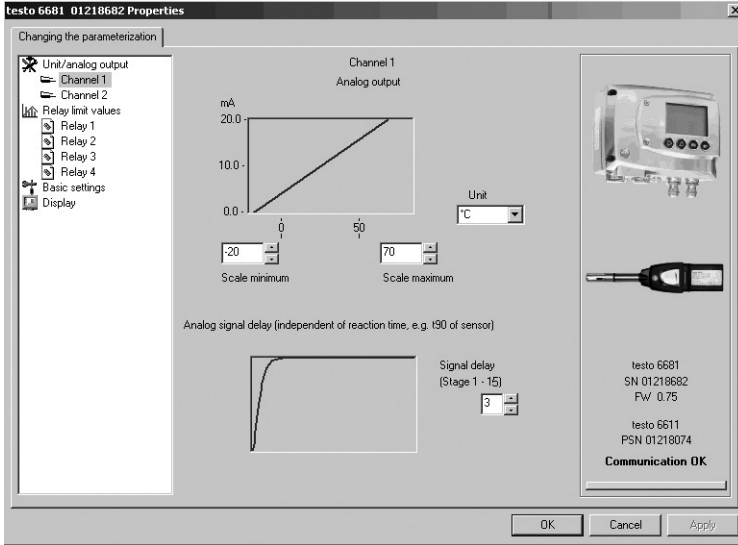

Unit/analog output (graphic)

Unit: 0 to 1 V/5 V/10 V or 4 to 20 mA.

Vertical: Current version of the analog output (cannot be changed).

Horizontal: Min./max. scale end points of selected unit.

The curve changes in accordance with the entered value of scale minimum and maximum.

Scale minimum/maximum

The endpoints of the scaling can be selected up to the stored scale minimum and maximum. In the process, scaling can take place beyond the measuring range in order to adjust the analog output to the customer system, see *volume 1, chapter 1.2.8, page 12*.

Field	Explanation
Unit	<p>Selection of the physical unit.</p> <p>When changing the unit, standard values are set for scale minimum and maximum (see transmitter instruction manual for the scale final values).</p> <p>Caution!</p> <p>When changing the phys. unit, the relay limit values are set to the assigned default values.</p>
Signal delay (graphic)	<p>Curve changes according to the set signal delay.</p>
Signal delay	<p>Time interval in stages of 1 to 15: 1 = no delay 15 = longest delay.</p> <p>The signal delay is added to the reaction time of the sensor. The signal delay shows averaging over the time interval of the selected stage in seconds:</p> <p>Example</p> <p>Stage 10 = average of the readings from the last 10 seconds.</p>
	<p>The delay of the signal in relation to the change in the process is also significantly influenced by the selection of the particle filter.</p>

Relay limit values 1 to 4

Explanation

In this mask, the relays or display alarms are parameterized



Only have the transmitter wired and connected by authorized personnel with the voltage disconnected.

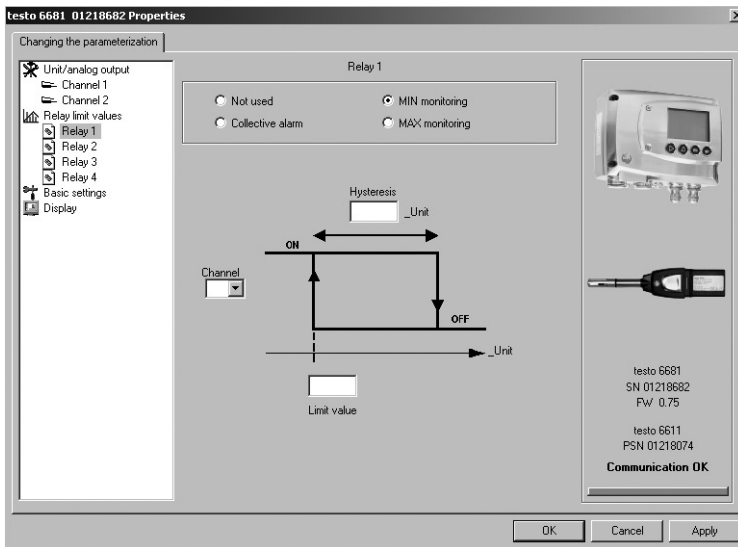

Relay x

Four relays are available (optional).

Not used

Relay is not used.

Hysteresis image and input options are hidden.

Collective alarm

A relay can be used as a collective alarm detector in the event that selected messages appear. See below for selection of the messages.

MIN monitoring

If switched to ON (NO contact) or OFF (NC contact) under the limit value; in the event of a subsequent exceeding of **limit value plus hysteresis**, it is switched to OFF (NO contact) or ON (NC contact).

Field	Explanation
MAX monitoring	If switched to ON (NO contact) or OFF (NC contact) above the limit value; in the event of a subsequent undershooting of limit value minus hysteresis , it is switched to OFF (NO contact) or ON (NC contact).
	The graphic display in the centre of the screen refers to the relay wiring as a NO contact (ON).
Hysteresis	To avoid switching cycles.
Channel	Selection of the channel that is to be monitored.
Limit value	Values for the limits of the unit selected in Unit/analog output ; 1 decimal place. When changing the phys. unit, the relay limit values are set to the default values.

Collective alarm

Explanation

Selection of the messages (error, etc.) that should result in a collective alarm (OR linkage).

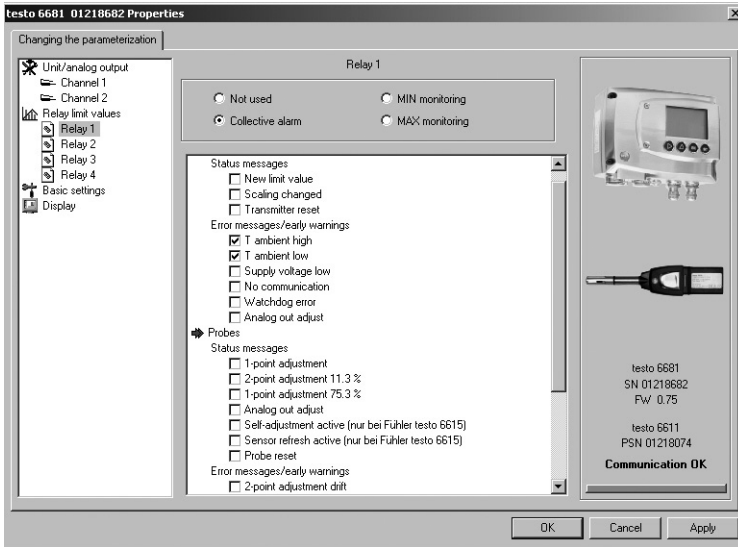

List field with checkboxes

Selection of which messages generated in the transmitter should be signalled as the collective alarm via the corresponding relay.

Basic settings

Explanation

Setting the absolute pressure and selection of the H₂O₂ evaporation process for the parameter °C_{tm}).

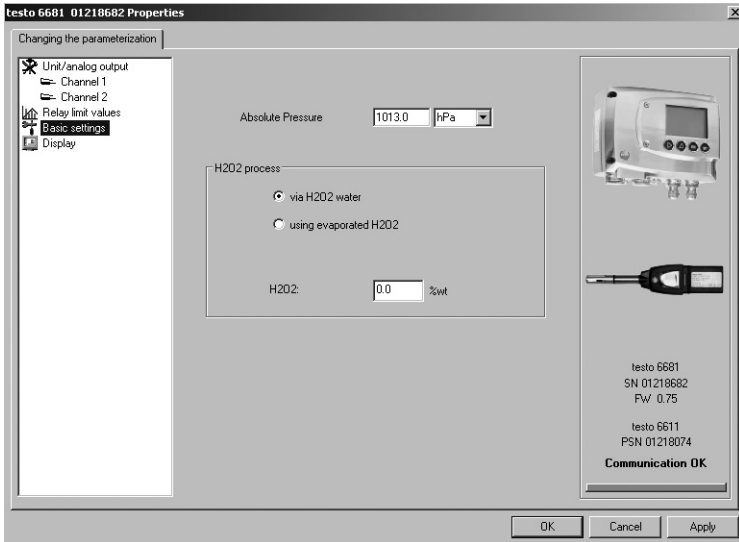

Absolute pressure

The absolute pressure is included in the calculation of the following units:

- °C_{td} or °F_{td}
- g/kg or gr/lb
- ppm_v/% vol.

H2O2 process

The calculation of the mixture dewpoint unit °C_{tm} is dependent upon the type of the evaporation process:

- passive: H₂O₂ solution evaporates (→ via H₂O₂ water)
- active: H₂O₂ solution is evaporated over a heated metal plate (→ with evaporated H₂O₂)
- Input field: Entering the weight proportion of the liquid H₂O₂ compared to water in %.

Display

Explanation

Setting the display functions (if a display is available on the transmitter).

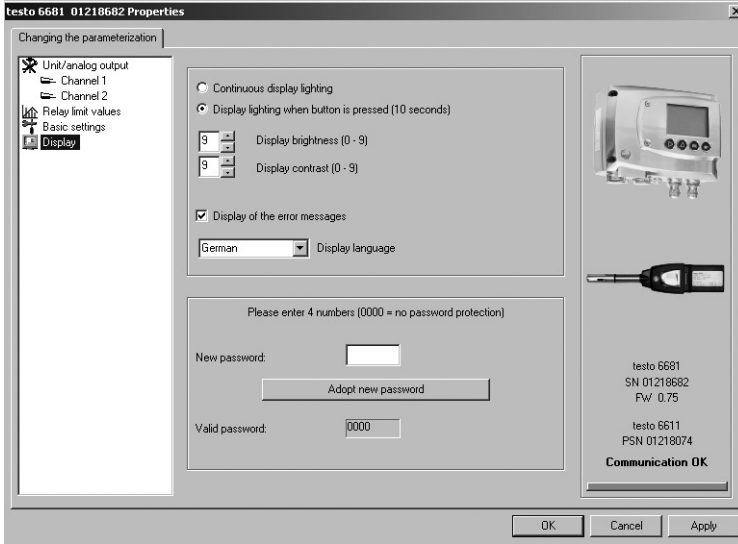

Continuous display lighting

Display lighting is permanently switched on.

Display lighting when button is pressed (10 seconds)

When a particular button on the instrument is pressed, the display lights up for 10 seconds.

Display brightness (0 to 9)

Setting the brightness between 0 and 9:
0 = dark
9 = light

Display contrast (0 to 9)

Setting the contrast between 0 and 9:
0 = lower contrast
9 = higher contrast.

Field	Explanation
Display language	Selection of the language.
New password	The password consists of four numbers, each of which must be between 1 and 9. If the password protection is not to be used, the numerical code "0000" must be entered.
Adopt new password	Button for confirming the new password.
Valid password	Display of the current password.

Self-adjustment	Explanation
	Parameterizing of testo 6615 probe, if this is used. (See <i>volume 1, chapter 1.3.3.6, page 40</i> and <i>chapter Fehler! Verweisquelle konnte nicht gefunden werden., page Fehler! Textmarke nicht definiert.</i>)

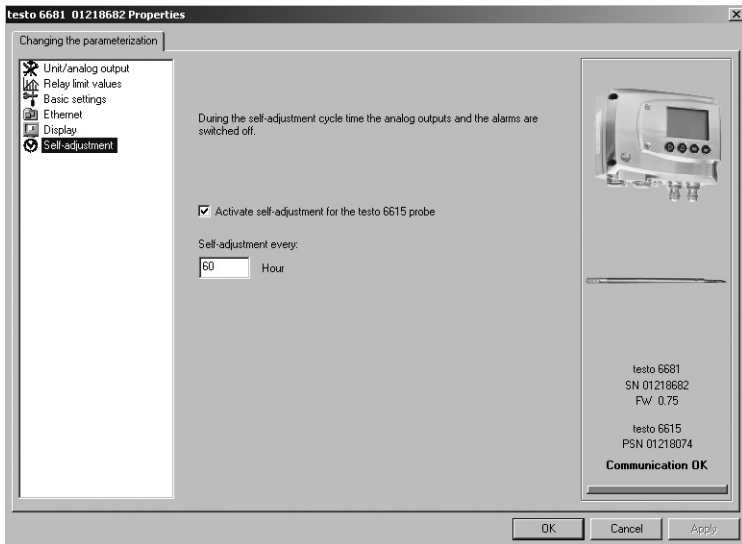

Activate self-adjustment	Perform adjustment of testo 6615 probe (auto-correction). The automatic self-adjustment is switched on, which means the probe performs an offset adjustment every x hours. The frequency is given in hours.
--------------------------	---

3 Click on **[Apply]**.

Changes are saved.

3.3.2.2 Saving parameters

Parameters can be saved in new parameter files.

- 1 Mark instrument/parameter file
- 2 Click on **File > Save as** in the menu bar.
- 3 Select storage location and enter the file name.
- 4 Click on **[Save]**.

The new parameter file is shown in the file list.

Only the parameters are saved from an instrument file, the history data are not adopted.



The original name (Instrument type, Serial number) is suggested with the current date/time as standard, e.g. "testo 6681 01234578 061120 1403.cfp".

For a standard installation, the files are saved under "C:\Documents and Settings\All Users\Shared Documents\P2A Software". The path can differ depending on the version of the operating system.

3.3.2.3 Open parameter file

All parameter files stored in the standard directory path are automatically displayed in the file list when the software is started.

You can also open parameter files that are stored in other directories.

- 1 Click on **File > Open** in the menu bar.
- 2 Select the storage location and click on the requisite file.

- 3 Click on **[Open]**.

The selected file is opened. This can be changed and saved (see *chapter 3.3.2.2, page 127*).

3.3.2.4 Copying and pasting parameters

The parameters of a parameter file can be transmitted to an instrument file or another parameter file from the same instrument type.

- 1 Select file whose parameters are to be copied.
- 2 Click on **Edit > Copy** in the menu bar.
- 3 Select the file which is to be modified.
- 4 Click on **Edit > Paste** in the menu bar.

The parameters are transmitted to the file.



You can also use the common keyboard shortcuts for copying and pasting, i.e. CTRL C and CTRL V.

Parameters can also be transmitted using drag & drop, where you drag the icon of the parameter file onto the icon of the target instrument file.

3.3.2.5 Deleting instrument/parameter file

Instrument/parameter files can be deleted from the file list.

- 1 Click on the file that is to be deleted with the right mouse button.
- 2 Select the command **Delete** in the context menu.

The instrument or parameter file is deleted from the list.

3.3.3 Analyzing/testing the transmitter

In this section, you can test the outputs of the connected instrument, read off the limit values and reset the parameters to the factory settings.

The function is only available for instrument files.

3.3.3.1 Analyzing/testing the instrument

✓ The required instrument file is marked.

1 Click on [**Test/analyze transmitter**].

The **Properties of <Instrument type> <Serial number>** dialogue is opened with the **Test/analyze transmitter** register.

2 Perform action:

Action	Explanation
Carry out factory reset:	Reset the unit, limit value and hysteresis parameters to factory settings (see <i>chapter 3.3.3.2, page 129</i>).
Test analog output:	Test channel 1/2/3 (optional) (see <i>chapter 3.3.3.3, page 130</i>).
Test switch outputs:	Manually switch relays 1 to 4 to test for proper function (see <i>chapter 3.3.3.4, page 131</i>).
Min./max. values display:	Overview of the minimum and maximum values measured since the last reset of the transmitter (see <i>chapter 3.3.3.5, page 133</i>).

3 Click on [**OK**] or [**Cancel**] to close the dialogue.

3.3.3.2 Carry out factory reset

✓ The required instrument file is marked.

1 Click on [**Test/analyze transmitter**].

The **Properties of <Instrument type> <Serial number>** dialogue is opened with the **Test/analyze transmitter** register.

2 Mark **Transmitter test**.

Current operating hours are shown.

3 Confirm control query to perform the reset.

The values are reset to the customer-specific factory settings.

4 Click on [**OK**] or [**Cancel**] to close the dialogue.

3.3.3.3 Testing channel 1/2/3 analog output

✓ The required instrument file is marked.

1 Click on [Test/analyze transmitter].

The **Properties of <Instrument type> <Serial number>** dialogue is opened with the **Test/analyze transmitter** register.

2 Mark channel and test values.

Field/button	Explanation
	Checking the analog outputs (see <i>volume 1, chapter 1.4.6.6, page 52</i>).

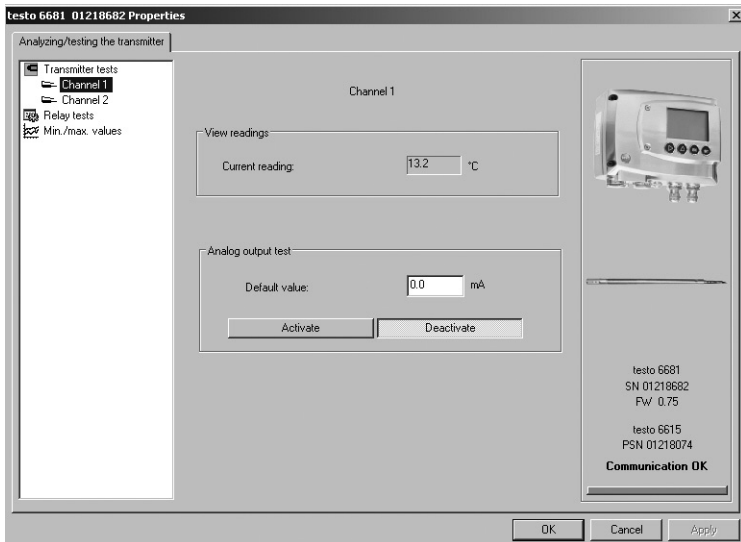

Current reading Readings are updated every second.

Unit Unit according to the type of analog output.

Default value Freely definable output value for the respective type of analog output (V or mA), 1 decimal place.

Field/button	Explanation
[Activate]	<p>The entered default value is forwarded to the corresponding analog output and to the test contacts by clicking.</p> <p>A warning informs that the value is being transmitted to the connected instrument in the event of existing cabling.</p> <p>Now check the analog output using a precise multimeter.</p>
[Deactivate]	<p>Finish entering the electrical variables at the analog output.</p> <p>The analog output returns to the Current reading again.</p>

- 3 Click on **[OK]** or **[Cancel]** to close the dialogue.
The analog output returns to Measuring Mode again.

3.3.3.4 Testing switch output relays 1 to 4

- ✓ The required instrument file is marked.
- 1 Click on **[Test/analyze transmitter]**.
The **Properties of <Instrument type> <Serial number>** dialogue is opened with the **Test/analyze transmitter** register.
 - 2 Mark **Relay tests** and test the values.

Field/button	Explanation
	Check the relay function (see <i>volume 1, chapter 1.4.6.6, page 52</i>).

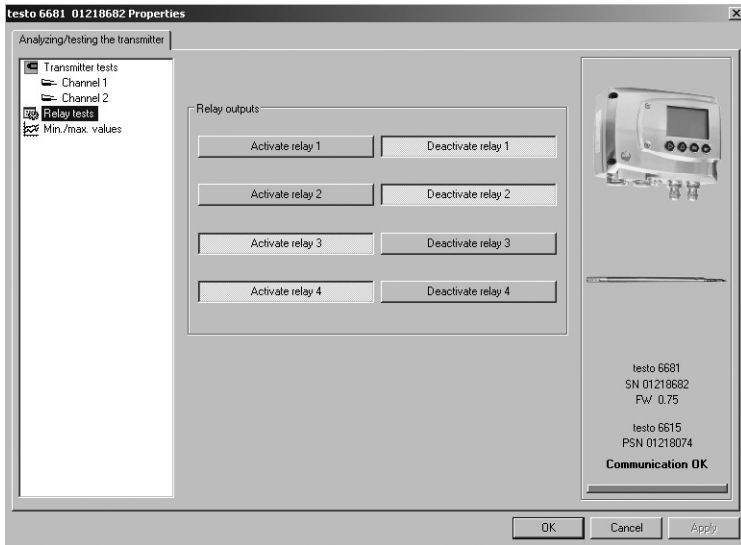

[Activate relay n] Close contact.
A warning informs that the value is being transmitted to a connected PLC, external display, etc. in the event of existing cabling.

[Deactivate relay n] Open contact.
A warning informs that the value is being transmitted to a connected PLC, external display, etc. in the event of existing cabling.

- 3 Click on **[OK]** or **[Cancel]** to close the dialogue.
The analog output returns to Measuring Mode again.

3.3.3.5 Displaying min./max. values

The transmitter saves the minimum or maximum value for each channel (measured since the last voltage supply or since the last manual reset).

- ✓ The required instrument file is marked.

1 Click on [Test/analyze transmitter].

The **Properties of <Instrument type> <Serial number>** dialogue is opened with the **Test/analyze transmitter** register.

2 Mark Min./max. values.

Field/button	Explanation
	View the min./max. values of each channel.

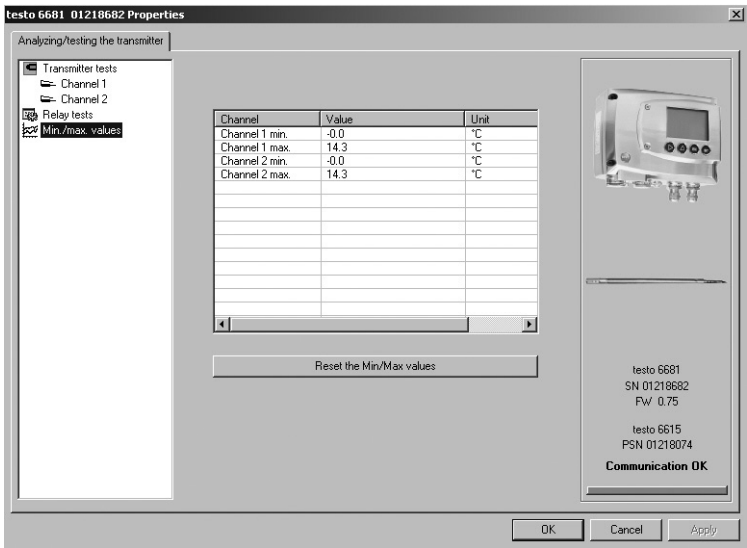

Channel	Min./max. of channel 1/2/3 (optional)
Value	Min. or max. value, 1 decimal place.
Unit	Unit selected in Unit/analog output .

3 Reset Min./max. values.

- 4 Click on **[Reset the min./max. values]**.
- 5 Confirm control query to perform the reset.
The values are reset to the default settings.
- 5 Click on **[OK]** or **[Cancel]** to close the dialogue.

3.3.4 Adjusting the transmitter

This function is used to adjust an attached instrument. The following adjustments may be carried out using the software:

- 1-point adjustment (offset)
- 2-point adjustment (upper and lower adjustment point)
- Analog adjustment (entry via assistant/wizard).

Also see *volume 1, chapter 1.3.3, page 31*, for this.

3.3.4.1 1-point adjustment



The testo 400/650 with precision humidity probe (order no. 0636 9741) is recommended as the reference measuring instrument for 1-point adjustment (offset) (see *volume 1, chapter 1.3.3.2, page 32*).

- 1 Expose the reference measuring instrument and the instrument to be adjusted to the same constant conditions and wait for equalization period to lapse.
- 2 Mark the instrument file of the connected instrument.
- 3 Click on **[Adjusting the transmitter]**.
The **Properties of <Instrument type> <Serial number>** dialogue is opened with the **Adjusting the transmitter** register.
- 4 Enter reference value and click on **[Carry out 1-point adjustment]**.
- 5 Confirm confirmation request.
The adjustment is carried out.

Field	Explanation
-------	-------------

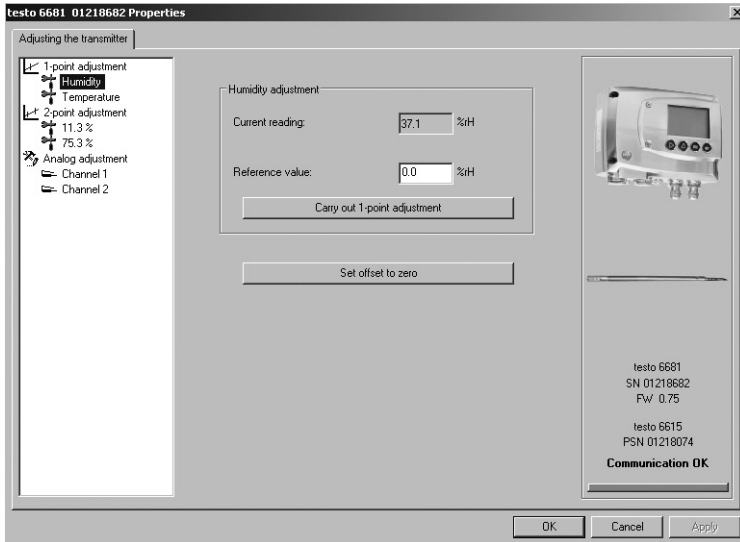

°C/°F Selection of the unit; only for temperature adjustment.

Current reading Reading in °C/°F or % RH.
 Readings are updated every second.

Reference value Entry of the read-off value from the reference measuring instrument.
 Permissible entries:
 - max. 5 % RH deviation (sum of all 1-point adjustments)
 - max. 2K (°C) deviation (sum of all 1-point adjustments)

- Click on [**Set offset to zero**] to reset a transmitted reference value.
 The current reading is used again.

6 Click on [**OK**] or [**Cancel**] to close the dialogue.

3.3.4.2 2-point adjustment

Also see *volume 1, chapter 1.3.3.3, page 34*



- 1 Expose the reference measuring instrument and the instrument to be adjusted to the same constant conditions and wait for equalization period to lapse.
- 2 Mark the instrument file of the connected instrument.
- 3 Click on **[Adjusting the transmitter]**.
The **Properties of <Instrument type> <Serial number>** dialogue is opened with the **Adjusting the transmitter** register.
- 4 Mark **11.3 %**, enter the reference value for the lower adjustment point and click on **[Lower adjustment point]**.
The adjustment is carried out.
- 5 Mark **75.3 %**, enter the reference value for the upper adjustment point and click on **[Upper adjustment point]**.
The adjustment is carried out.

Field	Explanation
-------	-------------

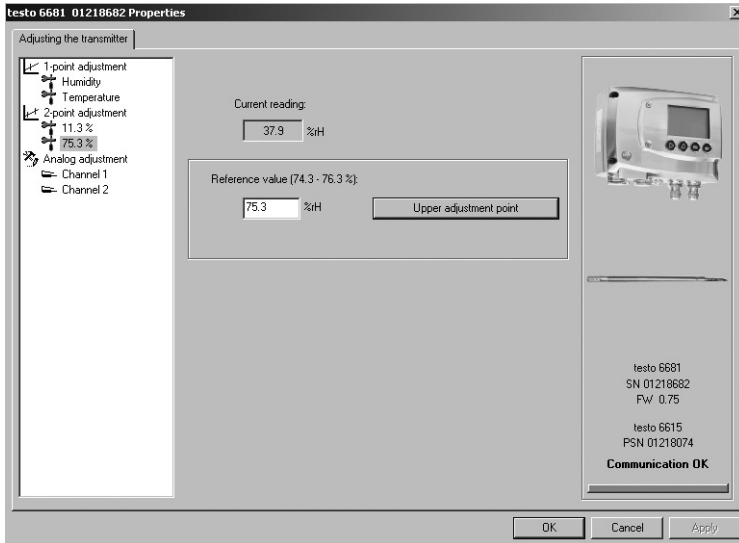

Current reading	Reading in % RH. Readings are updated every second.
-----------------	--

Reference value	Entry of the read-off value from the reference measuring instrument. Permissible entries: - Lower adjustment point 10.3 to 12.3 % RH - Upper adjustment point 74.3 to 76.3 % RH.
-----------------	---

6 Click on **[OK]** or **[Cancel]** to close the dialogue.

3.3.4.3 Adjusting the analog output

- 1 Connect precision multimeter (see *volume 1, chapter 1.3.3.4, page 37*).
- 2 Mark the instrument file of the connected instrument.
- 3 Click on **[Adjusting the transmitter]**.

The **Properties of <Instrument type> <Serial number>** dialogue is opened with the **Adjusting the transmitter** register.

- 4 Click on **[Start wizard...]** and follow the instructions of the wizard.
The adjustment is performed when the wizard is closed.

Field	Explanation
-------	-------------

Default value	<p>The analog output value is given at the output:</p> <ul style="list-style-type: none"> - Lower adjustment point: 10 % of the max. value - Centre adjustment point: 50% of the max. value - Upper adjustment point: 90 % of the max. value.
---------------	--

Measured analog value	<p>Required field: Entry of the value read off at the multimeter.</p>
-----------------------	---

3.3.5 Transmitter history

Parameterizations, adjustment processes and messages that have occurred are registered in the transmitter with an operating hours stamp.

In the history overviews (explained later in more detail), past processes and events can be made visible.



For parameter changes or adjustments that are performed directly at the instrument (via the user menu), "Transmitter" is entered in the **User** field and only the operating hour is entered in the **Date/time** field instead of operating hour/date/time.

For entries that are performed using the P2A software, the name of the user logged into Windows appears in the **User** field, while the operating hour is shown in the **Date/time** field.

- 1 Mark the instrument file of the connected instrument.
- 2 Click on [**Transmitter history**] button.

The "**Properties of <Instrument type> <Serial number>**" dialogue is opened with the **Transmitter history** register.

- 3 Click on the required entry in the list to change the display.

Parameterization history Explanation

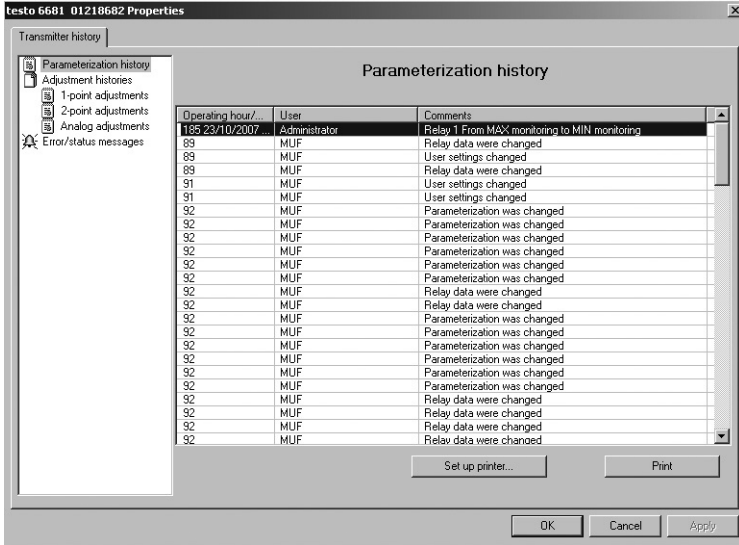

Date/time Format of the PC time is adopted from the settings of the operating system.

User Name with which the user is logged into the operating system.
 "MUF" (= transmitter) if the change was performed at the instrument.

Operating hours/date/time Operating hour/time stamp at which the change at the instrument was performed.

Comments Type of parameter change, e.g. "Unit of channel 2 from °F to °C".

Adjustment histories Explanation

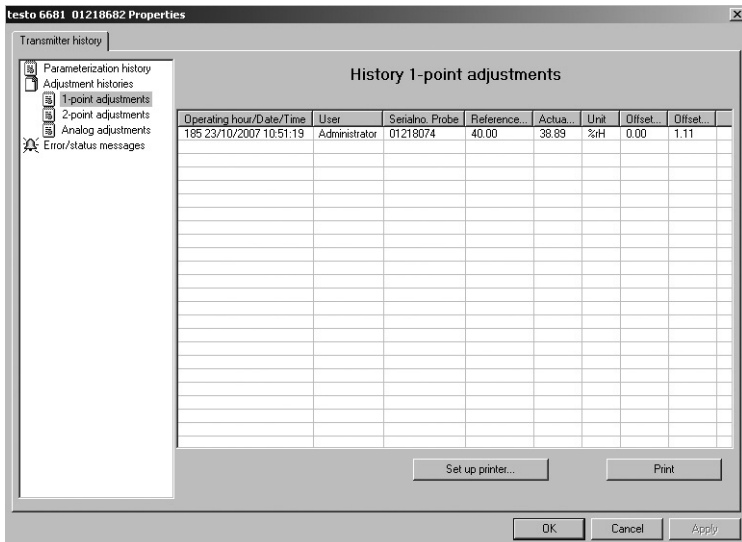

Selection: 1-point adjustments/2-point adjustments/Analog adjustments.

Date/time Format of the PC time is adopted from the settings of the operating system.

User Name with which the user is logged into the operating system.
"MUF" (= transmitter) if the change was performed at the instrument.

Operating hours/date/time Operating hour/time stamp at which the change at the instrument was performed.

Serial no. probe Serial number of the probe.

Reference value If no changes were performed, no value is displayed.

Unit Unit during the adjustment.

Column	Explanation
Actual value before adjustment	1-point adjustment: If no changes were performed, no value is displayed.
Offset from	1-point adjustment: Value before the adjustment.
Offset to	1-point adjustment: Value after the adjustment.
Offset	2-point adjustment: Difference between target and actual value reported by instrument.
Channel	Analog adjustment: Channel 1 to n.
Specification	Analog adjustment: Actual value.
Reading	Analog adjustment: Reference value entered.
Offset	Analog adjustment: Deviation at time of adjustment.

Error/status messages **Explanation**

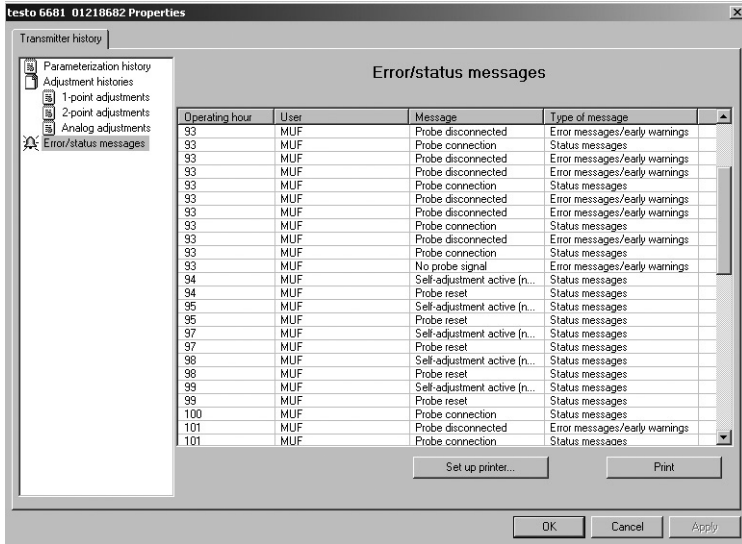

The table is shown only for error and status messages that were generated in the transmitter and were transferred and saved there via the connection to the P2A software.

Date/time Format of the PC time is adopted from the settings of the operating system.

Operating hours Operating hour at which the message appeared in the instrument.

User "MUF" (= transmitter) because the message was generated in the transmitter.

Message e.g. "Wrong probe". A non-compatible probe was connected.

Type of message e.g. early warning, status message.

- To print out the history data, click on **[Print]**.



The printing job is automatically sent to the default printer for the operating system.

The printout can be edited using **[Set up printer...]**.

- 4 Click on **[OK]** or **[Cancel]** to close the dialogue.

4 Tips and assistance

4.1 Questions and answers

Question	Possible causes/solutions
Connection to instrument cannot be established	Check connection cable/plug contacts
A message appears on the display	See <i>volume 1, chapter 1.5, page 59</i> .
Malfunction (with or without display)	Analysis using the P2A software, see <i>chapter 3.3.3, Analyzing/testing the transmitter, page 128</i> .
Undo adjustment	<p>A 1-point temperature/humidity adjustment can be reset to the current reading using [Set offset to zero].</p> <p>The actual values before the adjustment can be read out from the corresponding history table.</p> <p>2-point adjustments and analog adjustments can only be undone by means of a factory reset.</p>
When does a stable current reading appear?	After approx. 20 seconds

If we could not answer your question, please contact your dealer or Testo Customer Service. For contact data, see back of this document or web page www.testo.com/service-contact

4.2 Accessories and spare parts



An overview of the probes that can be used with the testo 6681 can be found in *chapter 1.2.2, page 10*.

Designation	Article no.
Interface and software	
P2A software (parameterizing, adjusting, analyzing) incl. USB adapter	0554 6020
testo 400/650 adapter	0554 6022
Fastenings, assembly aids	
Wall/duct bracket with M3 screw for fastening the transmitter to the probe and the probe to the wall/duct	0554 6651
Single-hole plastic duct screw connection	0554 1793
Duct screw connection (aluminium/PVC)	0554 1794
Pressure-tight G 1/2" screw connection with cutting ring up to 16 bar	0554 1795
Pressure-tight G 1/2" screw connection with PTFE ring up to 6 bar	0554 1796
Stainless steel flange for screw connections in accordance with DIN 2576	0554 1797
Plug-in connections	
Set of M12 plug-in connections (connector and socket) for power and signal lines	0554 6682
Profibus	
Profibus connector and Profibus socket	0554 6683
Profibus expansion module (Profibus DP interface)	0554 6686
Profibus T-piece	0554 6687
Profibus terminating resistor	0554 6688

Designation	Article no.
Dewpoint measurement (only with testo 6615)	
Pre-filter for the protection of the measurement chamber and sensor from contamination	0554 3311
Precision chamber for adjustable flow impact	0554 3312
Through-flow gauge for the measurement chamber, for adjusting the specified flow impact onto the sensor	0554 3313
Ethernet	
Ethernet module for installation by customer	0554 6656
Ethernet plug	0554 6653
Sensor filters and protective caps	
Stainless steel sintered filter	0554 0647
Wire mesh filter	0554 0757
Sintered PTFE filter	0554 0759
Protection cap made of metal (open)	0554 0755
PTFE protection cap with drip hole	0554 9913
Condensation protector	0554 0166
Filter for H ₂ O ₂ atmospheres	0554 6000
H ₂ O ₂ protection cap	0699 5867/1
Adjustment equipment	
Humidity adjustment set (11.3/75.3 % RH)	0554 0660
Reference set (testo 650, 1 % RH probe with certificate)	0699 3556/15
Control and adjustment set for wood moisture (testo 6614)	0554 0662
Adjustment adapter (for 1-point adjustment with testo 400 or testo 650)	0554 6022
Extension and adjustment cable	0554 6610
Supply	
Mains unit (desktop, wall-mounted)	0554 1748
Mains unit (top-hat rail mounting)	0554 1749
External display	
Prozess display testo 54-2 AC....	5400 7553
Prozess display testo 54-7 AC....	5400 7555

Designation	Article no.
Calibration	
Standard ISO calibration certificate, transmitter only	0520 1000
Standard DAkkS calibration certificate, transmitter only	0520 1200
Standard ISO calibration certificate, transmitter + probes	0520 0176
Special ISO calibration certificate, transmitter + probes	0520 0066
Standard DAkkS calibration certificate, transmitter + probes	0520 0276
Special DAkkS calibration certificate, transmitter + probes	0520 0236
ISO- calibration certificate humidity, probes	0520 0076
DAkkS calibration certificate temperature, probes	0520 0261

4.2.1 Ordering options for testo 6681 transmitter (0555 6681)

Order code	Characteristic
Axx	
Version	
A01	Currently no further selection of variants
Bxx Analog output	
B01	4 to 20 mA (2-wire, 24 VDC) (not with relay, not with testo 6614, 6615 probes), not with Ethernet module
B02	0 to 1 V (4-wire, 24 VAC/DC)
B03	0 to 5 V (4-wire, 24 VAC/DC)
B04	0 to 10 V (4-wire, 24 VAC/DC)
B05	0 to 20 mA (4-wire, 24 VAC/DC)
B06	4 to 20 mA (4-wire, 24 VAC/DC)
B77	Profibus-DP
Cxx	
Display	
C00	without display
C02	with display/English
C03	with display/German
C04	with display/French
C05	with display/Spanish
C06	with display/Italian
C07	with display/Japanese
Dxx Cable entry	
D01	M16 PG screw connection (with relay, also M20)
D02	Cable entry NPT 1/2"
D03	Plug-in connections for power and signal lines
Exx Ethernet module	
E00	without Ethernet module
E01	with Ethernet module

Order code	Characteristic
Fxx	
Channel 1 Unit	
F01	% RH/Min/Max
F02	°C/Min/Max
F03	°F/Min/Max
F04	°Ctd/Min/Max
F05	°Ftd/Min/Max
F06	g/kg /Min/Max
F07	gr/lb /Min/Max
F08	g/m ³ /Min/Max
F09	gr/ft ³ /Min/Max
F10	ppm _{Vol} /min/max
F11	°C _{wb} /Min/Max (wet bulb)
F12	°F _{wb} /Min/Max (wet bulb)
F13	kJ/kg /Min/Max (enthalpy)
F14	hPa /Min/Max (water vapour partial pressure)
F15	inch H2O/Min/Max (water vapour partial pressure)
F18	% Vol / min / max
Gxx	
Channel 2 Unit	
G01	% RH/Min/Max
G02	°C/Min/Max
G03	°F/Min/Max
G04	°Ctd/Min/Max
G05	°Ftd/Min/Max
G06	g/kg /Min/Max
G07	gr/lb /Min/Max
G08	g/m ³ /Min/Max
G09	gr/ft ³ /Min/Max
G10	ppm _{Vol} /min/max
G11	°C _{wb} /Min/Max (wet bulb)
G12	°F _{wb} /Min/Max (wet bulb)
G13	kJ/kg /Min/Max (enthalpy)
G14	hPa /Min/Max (water vapour partial pressure)
G15	inch H2O/Min/Max (water vapour partial pressure)

Order code	Characteristic
G18	% Vol / min / max
Hxx Relay	
H00	without relay
H01	4 relay outputs, limit value monitoring
H02	4 relay outputs, channel 1 limit values and collective alarm
Ixx Optional 3rd analog output	
I00	no optional 3rd analog output
I01	% RH/Min/Max
I02	°C/Min/Max
I03	°F/Min/Max
I04	°Ctd/Min/Max
I05	°Ftd/Min/Max
I06	g/kg /Min/Max
I07	gr/lb /Min/Max
I08	g/m ³ /Min/Max
I09	gr/ft ³ /Min/Max
I10	ppm _{Vol} /min/max
I11	°C _{wb} /Min/Max (wet bulb)
I12	°F _{wb} /Min/Max (wet bulb)
I13	kJ/kg /Min/Max (enthalpy)
I14	hPa /Min/Max (water vapour partial pressure)
I15	inch H ₂ O/Min/Max (water vapour partial pressure)
I16	°C _{tm} (H ₂ O ₂ mixture dewpoint)
I17	°F _{tm} (H ₂ O ₂ mixture dewpoint)
I 18	% Vol / min / max

Order code	Characteristic
Kxx	
Instruction manual languages	
K01	German/English instruction manual
K02	French/English instruction manual
K03	Spanish/English instruction manual
K04	Italian/English instruction manual
K05	Dutch/English instruction manual
K06	Japanese/English instruction manual
K07	Chinese/English instruction manual

4.2.2 Ordering options for testo 6610 probes (0555 6610)

Order code	Characteristic
Lxx	
Probe type	
L 11	Probe 6611
L 12	Probe 6612
L 13	Probe 6613
L 14	Probe 6614
L 15	Probe 6615
L 17	Probe 6617
Mxx	
Protective filter	
M 01	Stainless steel sintered filter
M 02	Metal wire protection cap
M 03	Sintered PTFE filter
M 04	Open metal protection cap
M 06	PTFE filter with drip hole
M 07	PTFE filter with drip hole and condensation protector
M 08	Filter for H ₂ O ₂ atmospheres
Nxx	
Cable length	
N 00	Without cable (testo 6611)
N 01	1 m cable length (testo 6613, 6614, 6615, 6617)
N 02	2 m cable length (testo 6613, 6614, 6615, 6617)
N 05	5 m cable length (testo 6613, 6614, 6615, 6617)
N 10	10 m cable length (testo 6613, 6614, 6615, 6617)
N 23	Cable length specifically for duct versions (testo 6612)
Pxx	
Probe length	
P 07	Probe length approx. 70 mm (testo 6611)
P 12	Probe length approx. 120 mm (testo 6613)
P 20	Probe length approx. 200 mm (testo 6611, 6612, 6613, 6614, 6615, 6617)
P 30	Probe length approx. 300 mm (testo 6612, 6613, 6614)

Order code	Characteristic
P 50	Probe length approx. 500 mm (testo 6612, 6613, 6614, 6615, 6617)
P 80	Probe length approx. 800 mm (testo 6612, 6613)



testo AG

Postfach 1140, D-79849 Lenzkirch
Testo-Straße 1, D-79853 Lenzkirch
GERMANY

Phone: +49 (0) 7653 681-0

Fax: +49 (0) 7653 681-100

Internet: www.testo.com

email: info@testo.com
