

PRESSURE PIPING SYSTEM

an *Aliaxis* company

★★★
LEAD-FREE
PIPE SYSTEMS

SUITABLE FOR BUILDINGS,
HOUSES AND CIVIL
CONSTRUCTION PURPOSES.

A photograph showing a large stack of metal pipes in the foreground, with a blurred industrial background. The pipes are arranged in a grid-like pattern, and the background shows various pieces of machinery and equipment in a factory or workshop setting.

CONTENTS



FEATURES & ADVANTAGES

- 2** Rubber Ring Joint Pressure System
- 4** Solvent Cement Joint Pressure System
-

ACCREDITATION & SPECIFICATION

- 6** Quality & Certification
- 7** Specifications & Standards
-

PRODUCT DETAILS

- 8** Pipe Marking for Traceability
- 9** Pressure Pipes - Rubber Ring Joint
- 10** Pressure Pipes - Solvent Cement Joint
- 12** Pressure Fittings
-

INSTALLATION

- 16** Installation Guidelines
- 18** Solvent Cement
- 24** FAQs
-

ABOUT US

- 25** About Paling Industries
- 25** About Aliaxis

PRODUCT RANGE

RUBBER RING JOINT PRESSURE SYSTEM

FEATURES

- Watertight joint for use under pressure – 6 to 15 bar applications
- The seal is formed between the socket and the spigot end
- Jointing rings are pre-assembled and supplied together with pipe from factory
- Lubricants approved for use with potable water supply lines are recommended
- Complies with MS 628, BS 3505 and SPAN listed
- Lead-free formulation



ADVANTAGES

- High Burst Strength and High Impact Strength
- Rigidity and Circularity
- No Risk of Seal Displacement during Installation
- Absorbs More Variations
- No Risk of Pulsation Leak



APPLICATION

Cold Water Pressure PVC-U Piping Systems are suitable for residential and commercial building applications.









PRODUCT RANGE

SOLVENT CEMENT JOINT PRESSURE SYSTEM

FEATURES

- Dimensions and performance exceed the requirement of standards
- High quality of finish with smooth internal and external surface
- Provides low coefficient of flow friction
- Materials are formulated to achieve strength that exceeds the performance of standards
- Lead-free formulation
- Complies with MS 628, BS 3505 and SPAN listed



ADVANTAGES

- Flame Resistance
- Thermal insulation
- Corrosion Resistance
- Strength to Weight Ratio
- Longer Lengths & Lightweight
- Higher Flexibility



APPLICATION

Solvent Cement joint are suitable for Residential and Commercial building Applications.





QUALITY & CERTIFICATION



SYSTEM CERTIFICATION

FITTINGS

1. Unplasticized Polyvinyl Chloride (PVC-U) Fittings For Water Supply

PIPES

1. Unplasticized Polyvinyl Chloride (PVC-U) Plain End, Socket End And Runner Sing Joint Pressure Pipes For Water Supply

SOLVENT CEMENT

1. Coloursolve Polyvinyl Chloride (PVC) Solvent Cements

PIPES

MODEL	NOM.SIZE (mm)	SPECIFICATION
PN6/ Class B	80, 100, 155, 200, 250 & 300	BS 3506/ BS4346:PT.2
PN9/ Class C	80, 100, 155, 200, 250 & 300	MS 628/ BS 3505/ BS 4346:PT.2
PN12/ Class D	32, 40, 50, 65, 80, 100, 155, 200, 250 & 300	MS 628/ BS 3505/ BS 4346:PT.2
PN15/ Class E	15, 20, 25, 32, 40, 50, 65, 80, 100, 155, 200, 250 & 300	MS 628/ BS 3505/ BS 4346:PT.2
Class 6	15, 20 & 25	BS 3506/ BS4346:PT.2
Class 7	15, 20, 25, 32, 40 & 50	BS 3506/ BS4346:PT.2

FITTINGS

MODEL	NOM.SIZE (mm)	SPECIFICATION
90° Bend Bell Mouth	80, 100 & 155	BS 4346
45° Bend Bell Mouth	80, 100 & 155	BS 4346
22.5° Bend Bell Mouth	80, 100 & 155	BS 4346
Double End Socket Bell Mouth	80, 100, 155, 200, 250 & 315	BS 4346
Faucet Elbow	15, 20 & 25	BS 4346
Equal Elbow	15, 20, 25, 32, 40, 40, 65, 80, 100, 155 & 200	BS 4346
90° Bend	15, 20, 25, 32, 40, 50, 65, 80, 100 & 155	BS 4346
45° Bend	15, 20, 25, 32, 40, 50, 65, 80, 100 & 155	BS 4346
Equal Tee	15, 20, 25, 32, 40, 50, 65, 80, 100, 155 & 200	BS 4346
Reducing Tee	20x15, 25x15, 25x20, 32x20, 32x25, 40x25, 40x32, 40x32, 50x32, 50x40, 80x50 & 100x80	BS 4346
Double End Socket	15, 20, 25, 32, 40, 50, 65, 80, 100, 155 & 200	BS 4346
Reducing Socket	20x15, 25x15, 25x20, 32x20, 32x25, 40x25, 40x32, 50x32, 50x40, 80x50 & 100x80	BS 4346
Reducing Bush	20x15, 25x15, 25x20, 32x25, 40x25, 40x32 & 50x32	BS 4346
Faucet Socket	15, 20, 25, 32, 40 & 50	BS 4346
Valve Socket	15, 20, 25, 32, 40 & 50	BS 4346
End Cap	15, 20, 25, 32, 40, 50, 65, 80 & 100	BS 4346
Tank Connector <i>with Straight Backnut</i>	15, 20 & 25	BS 4346
Tap Connector	15	BS 4346
45° Elbow	15	BS 4346
Threaded Plug	15 & 40	BS 4346

RUBBER RING JOINT PRESSURE PIPE

The Rubber Ring system is located on the tip of the spigot end of the pipe. When the pipes are joined, the rubbering is compressed from the tip down the barrel. The seal is formed between the socket and the spigot end. Jointing rings are supplied with the pipe.



SOLVENT CEMENT JOINT

Solvent Cement Jointing is a welding and not a glueing process, applying solvent cement resulting in a crosslinking effect between spigot and socket in pipes & fittings respectively. Hence achieving a good joint is critical in Solvent Cement Jointing. The spigot and socket end must be free from dust, cracked, damaged and be squared, in order to make a good joint.



SOCKET ENDED PIPES



PLAIN ENDED PIPES

PIPE MARKING FOR TRACEABILITY

- | | | |
|--|--|-----------------------------|
| 1: The word "PALING" or paling Logo with the word "PALING" | 4: Standard conformance and year of standard | 8: Manufacturing date |
| 2: The word SIRIM CERTIFIED or MS Logo | 5: Nominal size | 9: Manufacturing Shift code |
| 3: SIRIM License number | 6: Pressure rating | 10: Lead Free |
| | 7: Batch | 11: Quality Mark |

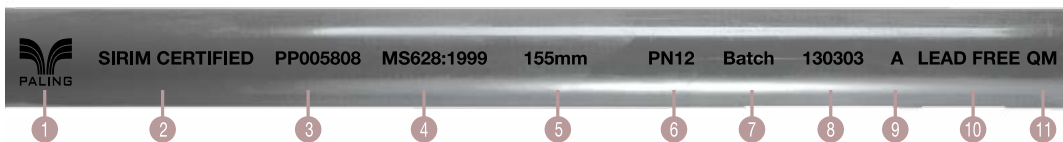

PIPES (RUBBER RING JOINT)

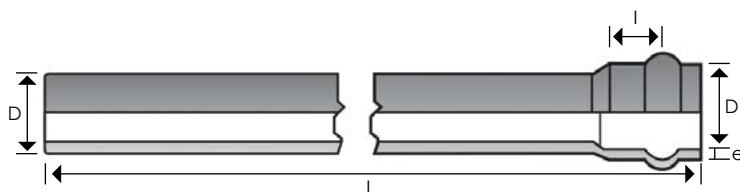

PN 6/ CLASS B

CODE NO.	NOM. SIZE (mm)	MEAN OUTSIDE DIAMETER D (mm)		WALL THICKNESS e (mm)		LENGTH L (m)	Insertion Length l (mm)	D1 (mm)
		(min)	(max)	(min)	(max)			
1101 080 58 P6 21	80	88.7	89.1	2.9	3.4	5.8	80	120
1101 100 58 P6 21	100	114.1	114.5	3.4	4.0	5.8	80	150
1101 155 58 P6 21	155	168	168.5	4.5	5.2	5.8	100	213
1101 200 58 P6 21	200	218.8	219.4	5.3	6.1	5.8	100	267
1101 250 58 P6 21	250	272.6	273.4	6.6	7.6	5.8	125	329
1101 300 58 P6 21	300	323.4	324.3	7.8	9.0	5.8	135	387

PN 9/ CLASS C

CODE NO.	NOM. SIZE (mm)	MEAN OUTSIDE DIAMETER D (mm)		WALL THICKNESS e (mm)		LENGTH L (m)	Insertion Length l (mm)	D1 (mm)
		(min)	(max)	(min)	(max)			
1101 080 58 P9 21	80	88.7	89.1	3.5	4.1	5.8	80	120
1101 100 58 P9 21	100	114.1	114.5	4.5	5.2	5.8	80	150
1101 155 58 P9 21	155	168	168.5	6.6	7.6	5.8	100	213
1101 200 58 P9 21	200	218.8	219.4	7.8	9.0	5.8	100	267
1101 250 58 P9 21	250	272.6	273.4	9.7	11.2	5.8	125	329
1101 300 58 P9 21	300	323.4	324.3	11.5	13.3	5.8	135	387

PN 12/ CLASS D

CODE NO.	NOM. SIZE (mm)	MEAN OUTSIDE DIAMETER D (mm)		WALL THICKNESS e (mm)		LENGTH L (m)	Insertion Length l (mm)	D1 (mm)
		(min)	(max)	(min)	(max)			
1101 080 58 P12 21	80	88.7	89.1	4.6	5.3	5.8	80	120
1101 100 58 P12 21	100	114.1	114.5	6	6.9	5.8	80	150
1101 155 58 P12 21	155	168	168.5	8.8	10.2	5.8	100	213
1101 200 58 P12 10	200	218.8	219.4	10.3	11.9	5.8	100	267
1101 250 58 P12 21	250	272.6	273.4	12.8	14.8	5.8	125	329
1101 300 58 P12 10	300	323.4	324.3	15.21	17.5	5.8	135	387

PN 15/ CLASS E

CODE NO.	NOM. SIZE (mm)	MEAN OUTSIDE DIAMETER D (mm)		WALL THICKNESS e (mm)		LENGTH L (m)	Insertion Length l (mm)	D1 (mm)
		(min)	(max)	(min)	(max)			
1101 080 58 P15 21	80	88.7	89.1	5.7	6.6	5.8	80	120
1101 100 58 P15 21	100	114.1	114.5	7.3	8.4	5.8	80	150
1101 155 58 P15 21	155	168	168.5	10.8	12.5	5.8	100	213
1101 200 58 P15 21	200	218.8	219.4	12.6	14.5	5.8	100	267
1101 250 58 P15 21	250	272.6	273.4	15.7	18.1	5.8	125	329
1101 300 58 P15 21	300	323.4	324.3	18.7	21.6	5.8	135	387

PIPES (SOLVENT CEMENT JOINT)

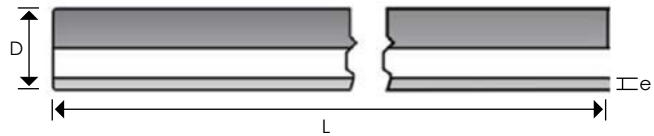

PN 6/ CLASS B

CODE NO.	NOM. SIZE (mm)	MEAN OUTSIDE DIAMETER D (mm)		WALL THICKNESS e (mm)		LENGTH L (m)
		(min)	(max)	(min)	(max)	
1100 080 58 P6 21	80	88.7	89.1	2.9	3.4	5.8
1100 100 58 P6 21	100	114.1	114.5	3.4	4.0	5.8
1100 155 58 P6 21	155	168	168.5	4.5	5.2	5.8
1100 200 58 P6 21	200	218.8	219.4	5.3	6.1	5.8
1100 250 58 P6 21	250	272.6	273.4	6.6	7.6	5.8
1100 300 58 P6 21	300	323.4	324.3	7.8	9.0	5.8

PN 9/ CLASS C

CODE NO.	NOM. SIZE (mm)	MEAN OUTSIDE DIAMETER D (mm)		WALL THICKNESS e (mm)		LENGTH L (m)
		(min)	(max)	(min)	(max)	
1100 080 58 P9 21	80	88.7	89.1	3.5	4.1	5.8
1100 100 58 P9 21	100	114.1	114.5	4.5	5.2	5.8
1100 155 58 P9 21	155	168.0	168.5	6.6	7.6	5.8
1100 200 58 P9 21	200	218.8	219.4	7.8	9.0	5.8
1100 250 58 P9 21	250	272.6	273.4	9.7	11.2	5.8
1100 300 58 P9 21	300	323.4	324.3	11.5	13.3	5.8

PN 12/ CLASS D

CODE NO.	NOM. SIZE (mm)	MEAN OUTSIDE DIAMETER D (mm)		WALL THICKNESS e (mm)		LENGTH L (m)
		(min)	(max)	(min)	(max)	
1100 032 58 P12 21	32	42.1	42.4	2.2	2.7	5.8
1100 040 58 P12 21	40	48.1	48.4	2.5	3.0	5.8
1100 050 58 P12 21	50	60.2	60.5	3.1	3.7	5.8
1100 065 58 P12 21	65	75.0	75.3	3.9	4.5	5.8
1100 080 58 P12 21	80	88.7	89.1	4.6	5.3	5.8
1100 100 58 P12 21	100	114.1	114.5	6.0	6.9	5.8
1100 155 58 P12 21	155	168.0	168.5	8.8	10.2	5.8
1100 200 58 P12 21	200	218.8	219.4	10.3	11.9	5.8
1100 250 58 P12 21	250	272.6	273.4	12.8	14.8	5.8
1100 300 58 P12 21	300	323.4	324.3	15.21	17.5	5.8

PN 15/ CLASS E

CODE NO.	NOM. SIZE (mm)	MEAN OUTSIDE DIAMETER D (mm)		WALL THICKNESS e (mm)		LENGTH L (m)
		(min)	(max)	(min)	(max)	
1100 015 58 P15 21	15	21.2	21.5	1.7	2.1	5.8
1100 020 58 P15 21	20	26.6	26.9	1.9	2.5	5.8
1100 025 58 P15 21	25	33.4	33.7	2.2	2.7	5.8
1100 032 58 P15 21	32	42.1	42.4	2.7	3.2	5.8
1100 040 58 P15 21	40	48.1	48.4	3.1	3.7	5.8
1100 050 58 P15 21	50	60.2	60.5	3.9	4.5	5.8
1100 065 58 P15 21	65	75.0	75.3	4.8	5.5	5.8
1100 080 58 P15 21	80	88.7	89.1	5.7	6.6	5.8
1100 100 58 P15 21	100	114.1	114.5	7.3	8.4	5.8
1100 155 58 P15 21	155	168.0	168.5	10.8	12.5	5.8
1100 200 58 P15 21	200	218.8	219.4	12.6	14.5	5.8
1100 250 58 P15 21	250	272.6	273.4	15.7	18.1	5.8
1100 300 58 P15 21	300	323.4	324.3	18.7	21.6	5.8

CLASS 6

CODE NO.	NOM. SIZE (mm)	MEAN OUTSIDE DIAMETER D (mm)		WALL THICKNESS e (mm)		PRESSURE RATING (bar)	LENGTH L (m)
		(min)	(max)	(min)	(max)		
1100 015 58 C6 21	15	21.2	21.5	2.8	3.3	28	5.8
1100 020 58 C6 21	20	26.6	26.9	2.9	3.4	22	5.8
1100 025 58 C6 21	25	33.4	33.7	3.4	4.0	24	5.8

CLASS 7

CODE NO.	NOM. SIZE (mm)	MEAN OUTSIDE DIAMETER D (mm)		WALL THICKNESS e (mm)		PRESSURE RATING (bar)	LENGTH L (m)
		(min)	(max)	(min)	(max)		
1100 015 58 C7 21	15	21.2	21.5	3.7	4.3	40	5.8
1100 020 58 C7 21	20	26.6	26.9	3.9	4.5	32	5.8
1100 025 58 C7 21	25	33.4	33.7	4.5	5.2	32	5.8
1100 032 58 C7 21	32	42.1	42.4	4.8	5.5	28	5.8
1100 040 58 C7 21	40	48.1	48.4	5.1	5.9	25	5.8
1100 050 58 C7 21	50	60.2	60.5	5.5	6.3	22	5.8

EQUAL TEE

To solvent weld pipes at both end.

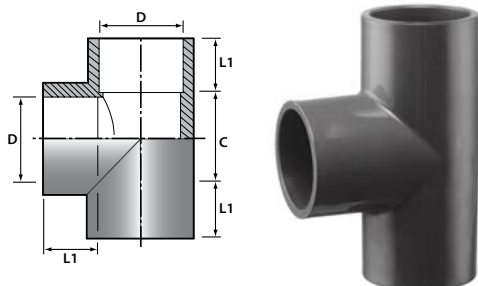

CODE NO.	NOM. SIZE (mm)	DIMENSIONS (mm)		
		L1	C	D
2106 015 P15 21	15	25	29	15
2106 020 P15 21	20	27	33	20
2106 025 P15 21	25	25	32	25
2106 032 P15 21	32	34	51	32
2106 040 P15 21	40	38	57	40
2106 050 P15 21	50	43	73	50
2106 065 P15 21	65	44	81	65
2106 080 P12 21	80	50	104	80
2106 100 P12 21	100	63	129	100
2106 150 21	155	90	180	155
2106 200 21	200	155	232	200

REDUCING TEE

To solvent weld to pipes or fittings at each end.

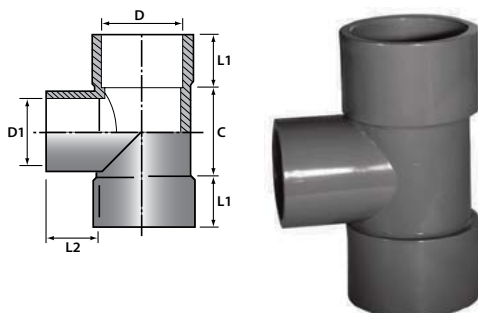

CODE NO.	NOM. SIZE (mm)	DIMENSIONS (mm)				
		L1	L2	C	D	D1
2107 020015 P15 21	20x15	23	22	27	20	15
2107 025015 P15 21	25x15	26	22	29	25	15
2107 025020 P15 21	25x20	26	23	32	25	20
2107 032020 P15 21	32x20	32	23	30	32	20
2107 032025 P15 21	32x25	32	26	41	32	25
2107 040025 P15 21	40x25	38	28	40	40	25
2107 040032 P15 21	40x32	38	34	50	40	32
2107 050032 P15 21	50x32	41	32	67	50	32
2107 050040 P15 21	50x40	41	35	67	50	40
2107 080050 P12 21	80x50	60	43	64	80	50
2107 100080 P12 21	100x80	72	60	94	100	80

DOUBLE END SOCKET

To solvent weld to pipes.

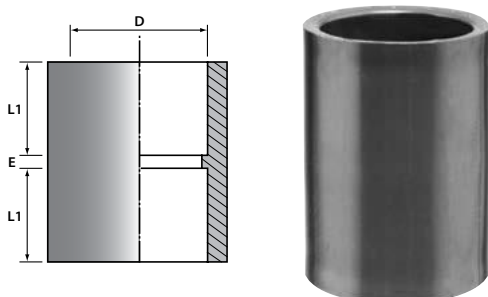

CODE NO.	NOM. SIZE (mm)	DIMENSIONS (mm)		
		L1	E	D
2108 015 P15 21	15	24	2	15
2108 020 P15 21	20	26	3	20
2108 025 P15 21	25	28	4	25
2108 032 P15 21	32	35	10	32
2108 040 P15 21	40	38	8	40
2108 050 P15 21	50	39	10	50
2108 065 P12 21 [^]	65	60	22	65
2108 080 P12 21 [^]	80	77	22	80
2108 100 P12 21 [^]	100	97	51	100
2108 155 P12 21 [^]	155	140	52	155
2108 200 P12 21 [^]	200	190	55	200

[^] Fabrication item

REDUCING SOCKET

To solvent weld to pipes of different diameters.

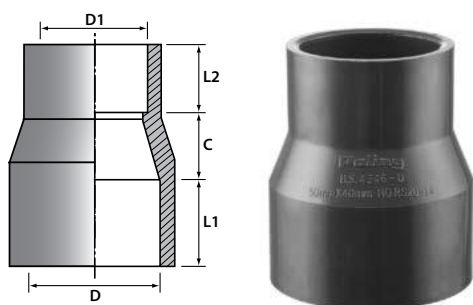

CODE NO.	NOM. SIZE (mm)	DIMENSIONS (mm)				
		L1	L2	C	D	D1
2109 020015 P15 21	20x15	22	22	17	20	15
2109 025015 P15 21	25x15	23	16	15	25	15
2109 025020 P15 21	25x20	26	23	15	25	20
2109 032020 P15 21	32x20	30	22	18	32	20
2109 032025 P15 21	32x25	26	21	20	32	25
2109 040025 P15 21	40x25	33	26	19	40	25
2109 040032 P15 21	40x32	29	24	19	40	32
2109 050032 P15 21	50x32	36	26	19	50	32
2109 050040 P15 21	50x40	35	28	20	50	40
2109 080050 P12 21	80x50	55	41	31	80	50
2109 100080 P12 21	100x80	71	58	30	100	80

REDUCING BUSH

To solvent weld two pipes of different diameters.

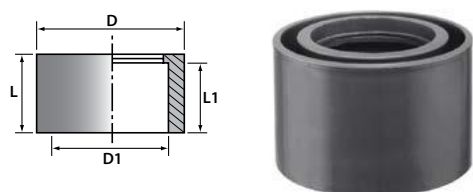

CODE NO.	NOM. SIZE (mm)	DIMENSIONS (mm)			
		L	L1	D	D1
2110 020015 P15 21	20x15	16	20	20	15
2110 025015 P15 21	25x15	28	19	25	15
2110 025020 P15 21	25x20	28	20	25	20
2110 032025 P15 21	32x25	31	28	32	25
2110 040025 P15 21	40x25	34	26	40	25
2110 040032 P15 21	40x32	35	30	40	32
2110 050032 P15 21	50x32	40	30	50	32

FAUCET SOCKET

To connect faucet or ball valves directly to PVC-U pipe.

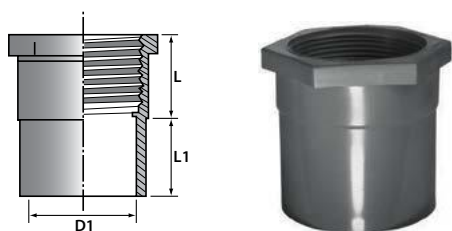

CODE NO.	NOM. SIZE (mm)	DIMENSIONS (mm)		
		L	L1	D1
2111 015 P15 21	15	27	21	15
2111 020 P15 21	20	23	34	20
2111 025 P15 21	25	26	36	25
2111 032 P15 21	32	40	30	32
2111 040 P15 21	40	42	37	40
2111 050 P15 21	50	36	38	50

VALVE SOCKET

To connect stop-valves to PVC-U pipe.

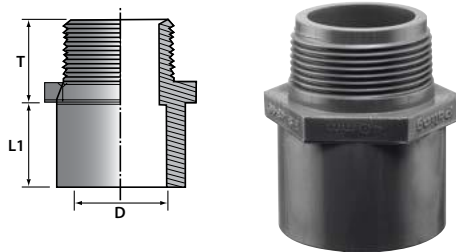

CODE NO.	NOM. SIZE (mm)	DIMENSIONS (mm)		
		L1	T	D
2112 015 P15 21	15	27	20	15
2112 020 P15 21	20	28	24	20
2112 025 P15 21	25	30	31	25
2112 032 P15 21	32	35	33	32
2112 040 P15 21	40	38	34	40
2112 050 P15 21	50	44	42	50

END CAP

To cap or seal end of PVC-U pipe with solvent cement.

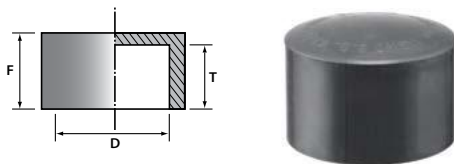

CODE NO.	NOM. SIZE (mm)	DIMENSIONS (mm)		
		F	T	D
2113 015 P15 21	15	26	22	15
2113 020 P15 21	20	28	20	20
2113 025 P15 21	25	30	25	25
2113 032 P15 21	32	37	16	32
2113 040 P15 21	40	40	33	40
2113 050 P15 21	50	44	36	50
2113 065 P15 21	65	-	44	65
2113 080 21	80	-	51	80
2113 100 21	100	-	63	100

TANK CONNECTOR

with Straight Backnut

To connect tank to faucet or G.I. socket.

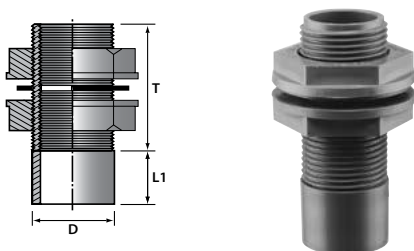

CODE NO.	NOM. SIZE (mm)	DIMENSIONS (mm)		
		L1	T	D
2124 015 P15 21	15	22	46	15
2124 020 P15 21	20	23	51	20
2124 025 P15 21	25	25	63	25

TAP CONNECTOR

To connect to basin faucets or valve socket of pipeline for easy maintenance and repair.

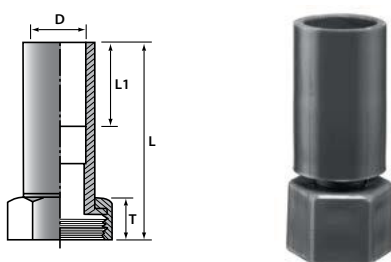

CODE NO.	NOM. SIZE (mm)	DIMENSIONS (mm)			
		L	L1	T	D
2115 015 P15 21	15	80	24	20	15

Also available in other configuration
i.e Tap Connector Elbow

45° ELBOW

To solvent weld pipes at both ends.

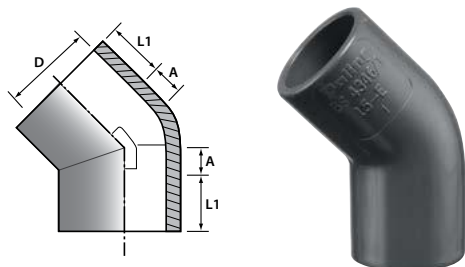

CODE NO.	NOM. SIZE (mm)	DIMENSIONS (mm)		
		L1	A	D
2117 015 P15 21	15	21	7	15

THREADED PLUG

To cap or seal end of PVC-U pipe.

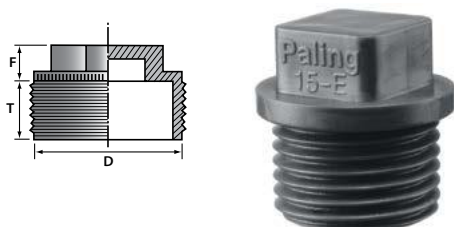

CODE NO.	NOM. SIZE (mm)	DIMENSIONS (mm)		
		F	T	D
2118 015 P15 21	15	11	12	23
2118 040 P15 21	40	18	21	49

FAUCET ELBOW

To connect faucet or ball valve to PVC-U water supply line.
Threaded at one end and solvent weld to pipe on the other end.

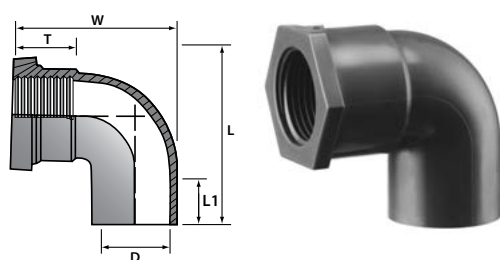

CODE NO.	NOM. SIZE (mm)	DIMENSIONS (mm)				
		L	L1	W	T	D
2102 015 P15 21	15	54	24	43	15	15
2102 020 P15 21	20	60	26	62	25	20
2102 025 P15 21	25	69	33	77	31	25

EQUAL ELBOW

To solvent weld pipes at both ends.

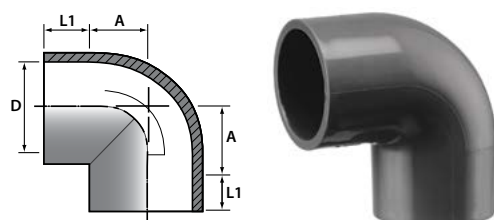

CODE NO.	NOM. SIZE (mm)	DIMENSIONS (mm)		
		L1	A	D
2103 015 P15 21	15	24	14	15
2103 020 P15 21	20	26	28	20
2103 025 P15 21	25	26	22	25
2103 032 P15 21	32	32	25	32
2103 040 P15 21	40	37	30	40
2103 050 P15 21	50	43	33	50
2103 080 P12 21	80	51	49	80
2103 100 P12 21	100	80	68	100
2103 155 21	155	90	90	155
2103 200 21	200	115	169	200

ASSEMBLY OF PIPES WITH RUBBER RING JOINTS



The assembly of one pipe to another may be performed using various methods. One of the most successful methods employs a rubber ring joint. The rubber ring joint may be either of integral socket design (formed as a continuous, homogeneous entity with the pipe) or it may consist of a separate sleeve-type coupling. The joint provides the following advantages:

- Allowance for expansion and contraction.
- Reliably assembled in poor weather conditions.
- Consistent reliability.
- Flexibility and resiliency.
- Labour saving and overall economical.
- Ease of installation.

JOINTING METHOD



Use only the lubricant supplied by Paling Industries Sdn Bhd

When the rings are colour coded, be sure to consult the pipe manufacturer or their literature for the difference. In all cases, clean the ring, the socket or the coupling interior, especially the groove (except when the ring is permanently installed) and the spigot with a rag, brush or paper towel to remove any dirt or foreign material before assembling. Inspect the ring, pipe spigot chamber, ring groove and sealing surfaces for damages or deformation. Use only rings which are designed for and supplied with the pipe. Insert them as recommended by the manufacturer.

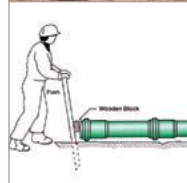

Lubricant should be applied as specified by the pipe manufacturer. Bacterial growth, damage to gaskets or the pipe, may result from the use of non-approved lubricants. Use only the lubricant supplied by the pipe manufacturer.

While keeping the lengths in paper alignment, brace the socket and push the spigot into the bell. The spigot should be inserted until the reference mark on the pipe barrel is even with the edge of the socket.

JOINTING METHOD FOR RUBBER RING JOINT



1. Clean dirt and grit from socket



2. Clean the exterior of the pipe before applying the lubricant



3. Apply lubricant on spigot



4. Insert the pipe until the white line

ADVANTAGES OF BELL-MOUTH JOINT WITH LOCKED-IN PIPE SEAL

Application advantages of Paling Bell-Mouth Rubber Ring Joint (RRJ) piping fitted with the locked-in pipe seal:

- High burst strength and high impact strength.
- Thickened pipe wall at the socket ensures rigidity and circularity are maintained under high external load and internal pressure.
- The seal is fitted in the pipe socket at the factory making pipe-laying work easier and faster.
- Accurately formed seal groove ensures that the locked-in seal is securely positioned in the groove during transport and assembly. Risk of seal displacement during installation is eliminated.
- Exclusive seal design maximizes the advantages of both sealing principles in a combined lip and compression seal. It reduces the assembly force required and absorbs any permissible variations in the groove.
- Sealing can withstand extremely high pressure without the seal being dislodged. No risk of pulsation leak due to wide pressure fluctuations in the pipeline.

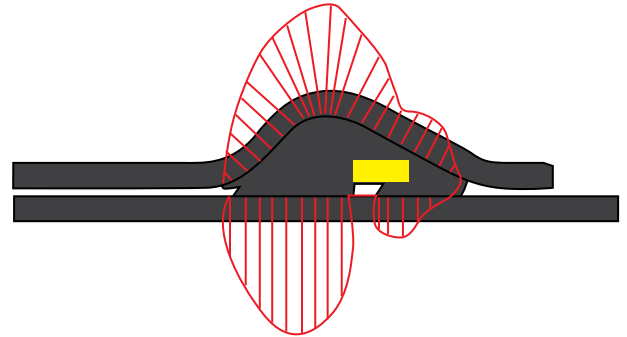
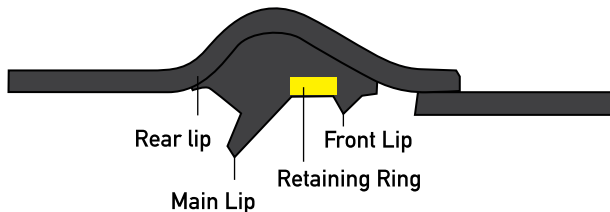

JOINT WITH DUAL HARDNESS PIPE SEAL

Application advantages of Paling Bell-Mouth Rubber Ring Joint (RRJ) piping fitted with the locked-in pipe seal:

- One piece constriction seal with Hard and Soft rubber bonded firmly together.
- Hard rubber for retaining. Soft rubber for sealing.
- No loose retaining ring or device needed.
- Designed to be retained tightly in the socket groove and yet, can be removed for cleaning purposes prior to assembly.
- The exclusive "DOUBLE COMPRESSION LIPS" design gives extra compression, hence provides additional sealing performance against spigot and socket.
- The sealing lip is designed to prevent sand and/or other foreign particles from penetrating the joint.

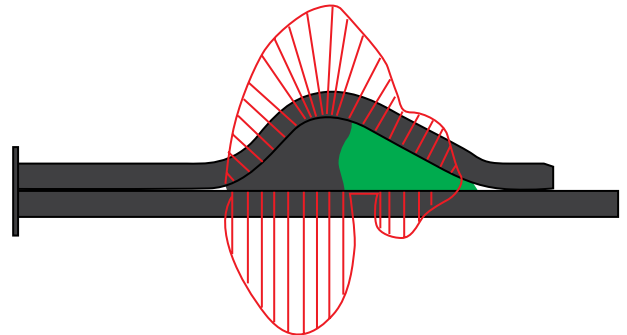
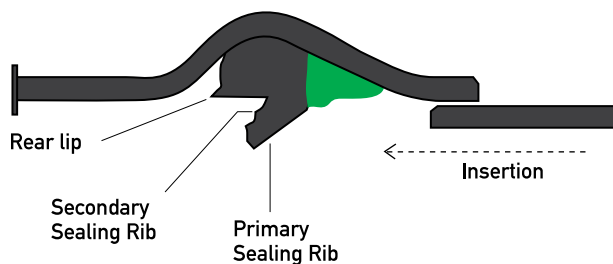

SOLVENT CEMENT

CODE NO.	DESCRIPTION	GMS	TIN/ CARTON
60500 70P	Paling Clearsolve fast dry	500	20
60100 70	Paling Clearsolve fast dry	100	60
60500 10	Paling Coloursolve slow dry (Blue)	500	20
60500 12	Paling Coloursolve fast dry (Green)	500	20





PRODUCT RANGE

SOLVENT CEMENT

FEATURES

- PVC Solvent Cement Fast Dry – for pipes and fittings $\leq 80\text{mm}$
- PVC Solvent Cement Slow Dry – for pipes and fittings $\geq 80\text{mm}$
- Moderate solvent odour
- Complies with MS 628 or BS 4346. SPAN listed



ADVANTAGES

- Colour Co-Polymer for Easier Application and Inspection
- Easy to Use
- Premium Quality
- Fast and Slow Drying Solvent available for Strong Bonding



APPLICATION

Paling Solvent Cement is formulated for PVC pipes used for rainwater and raingutter applications.



PALING COLOURSOLVE FAST DRY

Solid Content: 24%

Consistency property: 1,000 cps

Quality: Tough & Resilient

Solid consist of: MEK & CYC

Colour: Green

Standard: MS628 Part II Section 2.2

- Highly soluble fast dry PVC-U Solvent cement.
- Suitable for joining all PVC-U pipes from 15mm - 75mm diameter.
- When applied, it will instantly dissolve and blend with the pipe to produce a film (wall) of 0.4mm thick, so that the fitting gap will be strong and stable.

STRAINING TIME

Pipes with diameters 15mm	10 seconds
Pipes with diameters 25mm to 32mm	8 seconds
Pipes with diameters 50mm	6 seconds
Pipes with diameters 75mm	4 seconds

PALING COLOURSOLVE SLOW DRY

Solid Content: 24%

Consistency property: 1,000 cps

Quality: Tough & Resilient

Solid consist of: MEK, CYC & THF

Colour: Blue

Standard: MS628 Part II Section 2.2

- Highly soluble slow dry PVC-U Solvent cement.
- Suitable for joining all PVC-U pipes from 75mm - 200mm diameter.
- When applied, it will instantly dissolve and blend with the pipe to produce a film (wall) of 0.4mm thick, so that the fitting gap will be strong and stable.

STRAINING TIME

Pipes with diameters 25mm	20 seconds
Pipes with diameters 32mm to 50mm	16 seconds
Pipes with diameters 75mm to 100mm	12 seconds
Pipes with diameters 150mm	8 seconds
Pipes with diameters 200mm	4 seconds

ATTENTION:

1. Temperature below 15°C (50°F) will extend the straining period for approximately 5 minutes for each type of pipe.
2. All the above solvent cement is not applicable to those PVC-U pipe or fitting which are made of partly recycled material.
3. After assembly, the pipe must be tightly held in place and shall only be released after recommended straining time as stipulated. If release prematurely, the pipe to be fitted will spring apart.

PACKING

500g. (with brush) x 20 Tins per ctn.

CTN. SIZE

508mm x 220mm x 225mm

SOLVENT CEMENT REQUIREMENT FOR PVC-U PIPES & FITTINGS

NOMINAL SIZE OF PIPE OR FITTING (mm)	AMOUNT OF SOLVENT CEMENT REQUIRED PER JOINT (g)	NO OF POSSIBLE JOINTS	
		100 g	500 g
15	1.3	76	383
20	2.0	55	250
25	2.5	40	200
32	3.2	30	156
40	5.0	20	100
50	7.2	13	69
80	12.0	8	41
100	15.5	6	32
155	26.0	2	19
200	49.0	1	10

RECOMMENDATIONS ON BRUSH:

- A : Pipes with diameter 25mm and below - use brush as accompanied and affixed to can
 B : Pipes with diameter 32mm to 50mm - use 1" brush
 C : Pipes with diameter 75mm to 200mm - use 2" brush

PRESSURE TEST:

	TEST PRESSURE	DRYING TIME
Cold Water (20°C)	Below 12kg/cm ² (171psi)	After 1 hour
Hot Water (60°C)	Below 12kg/cm ² (171psi)	After 2 hours

PHYSICAL AND CHEMICAL PROPERTIES

Flash point: 15°C

Flammable Mixture (UN No. 1133)

This solvent cement material will ignite at ambient temperatures. Colourless vapours may travel considerable distance to ignition sources and cause flash fires or explosions.

Hazard Identification

May cause eyes and skin irritation, burns or dermatitis.

Storage

Store in well-ventilated area. Keep away from heat, sparks and flame.

Safety Advice

- Keep out of reach of children.
- Keep away from sources of ignition - No Smoking.
- Avoid contact with eyes.
- In case of fire, use chemical powder, foam or carbon dioxide.

ASSEMBLY PIPES WITH SOLVENT CEMENT JOINTS

-1- CUT & DEBURR

Where necessary, cut pipe to length at right angle to its axis to maximize surface for bonding. Use of a mitre box and fine tooth saw is recommended.

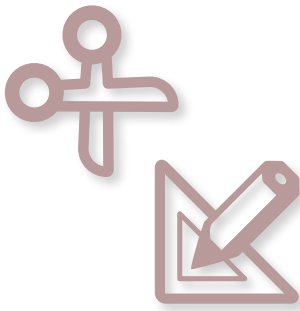

Cut surface need to be deburred and chamfered to a slight bevel to simplify centred insertion and uniform adhesive distribution between parts.

-2- DEGREASE THE SPIGOT AND SOCKET

Mark the insertion depth to the pipe spigot to avoid excessive application and provides control as to whether pipe has been adequately inserted into the fitting.



Clean parts to be fused with priming fluid to ensure that dirt and possible slip and release agents are removed for optimal results. Scrape off any discoloured pipe layer due to UV-radiation or proper bonding cannot be achieved.

-3- APPLY THE SOLVENT CEMENT

Apply adhesive evenly to both sides to be mated using a brushing stroke parallel to or along the pipe axis. It is recommended that a 1" brush be used to apply the solvent cement



can or tin well before using to ensure homogeneity.

for pipes with diameters between 32 to 50mm and 2" brush for pipes with diameters above 50mm. Joint must be made within 2 minutes of starting application.

-4- MAKE THE JOINT

Insert pipe straight into the fitting as deeply into the fitting socket as possible without twisting and hold in place firmly and steadily for at least ten seconds for Fast Dry and twenty seconds for Slow Dry.

Remove excess solvent cement with a soft cloth. A small closed adhesive ring should be clearly visible at the end of the fitting to signal that the sufficient adhesive has been applied.



-5- CLEAN THE EXCESS SOLVENT CEMENT

When making multiple joints on a piping system, an undisturbed rest period of at least five minutes is required before second bond can be carried out. This is to avoid stress to the first joint, which may weaken its adhesion.



Wait 24 hours before testing or use

TYPICAL LAYOUT

PRESSURE PIPE & FITTINGS SYSTEM

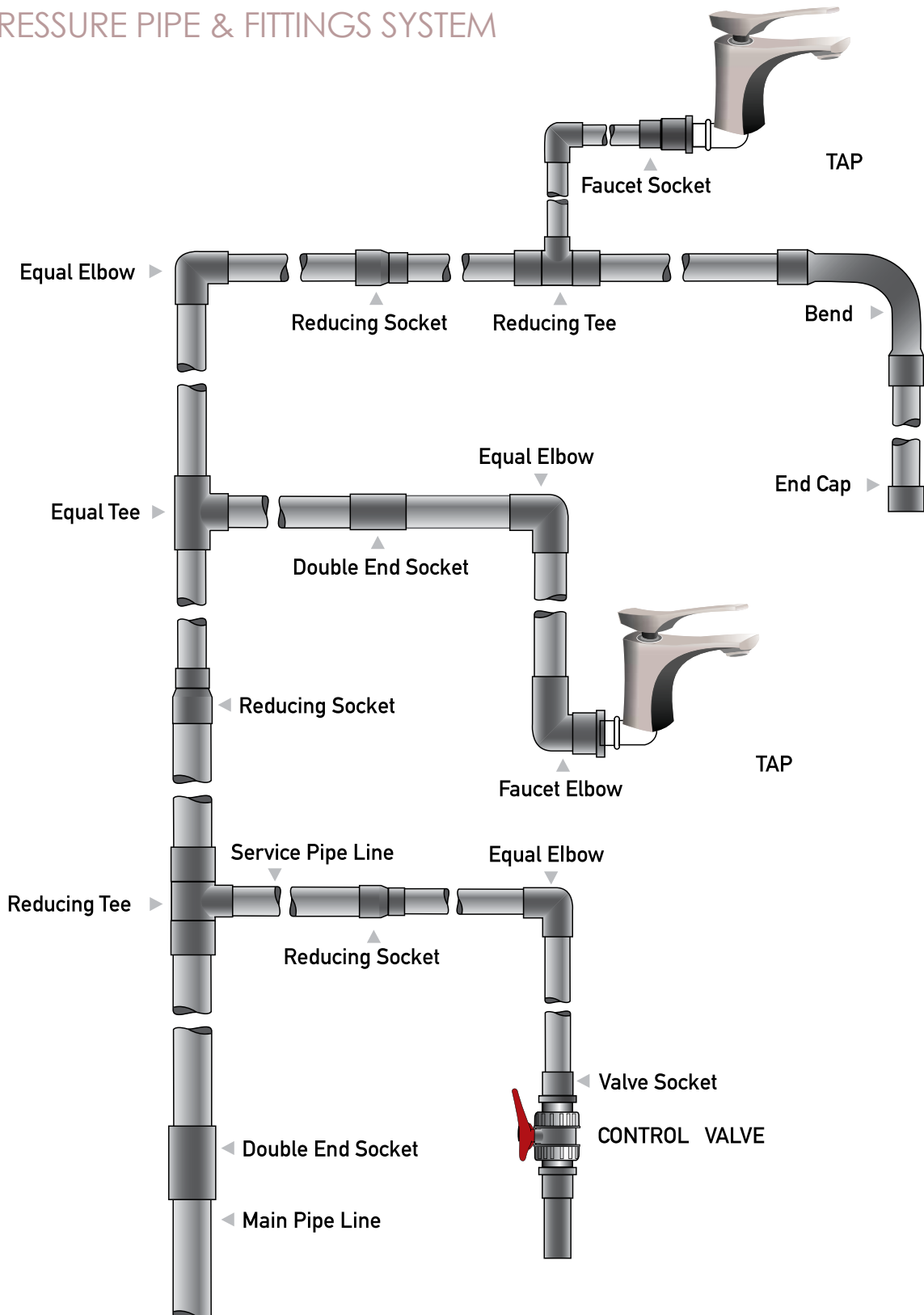



FREQUENTLY

ASKED QUESTIONS

CAN I USE PALING PRESSURE PIPE SYSTEMS FOR POTABLE WATER SUPPLY ?

Paling PVC Pressure Pipe Systems do not affect or alter water quality. The water that is carried in these pipes does not harm the health of consumers.

WHY PVC-U IS A PREFERRED MATERIAL FOR POTABLE WATER ?

PVC-U has excellent chemical resistance across its operating temperature range, within a broad band of operating pressures. PVC-U piping systems are frequently used for plastic pipe installations due to their long-term strength characteristics, high stiffness and cost effectiveness.

HOW FLEXIBLE IS A PVC-U PIPE SYSTEM ?

PVC-U enjoys a major advantage for buried applications, particularly where soil movement or vibration is anticipated. In pressure applications, the modulus of elasticity for PVC-U also reduces the magnitude of pressure surges (i.e. water hammer).

WHAT DO THE PRESSURE RATINGS AND CLASSES OF PVC PIPES MEAN ?

The different classes and ratings refer to the different designated operating pressures, under constant or static conditions, at a reference temperature of 20°C.

WHAT IS THE DESIGN COEFFICIENT FOR PVC-U PRESSURE PIPES ?

The design coefficient (safety factor) is defined in the overall design of all pressure systems that use plastic pipes. This takes into consideration the service conditions as well as the properties of all the components used within a piping system, in order to ensure safe and lasting service.



ABOUT PALING INDUSTRIES

PALING INDUSTRIES SDN. BHD. WAS ESTABLISHED IN 1971 TO PRODUCE uPVC PIPES & FITTINGS IN MALAYSIA. OVER THE YEARS IT HAS EXPANDED ITS RANGE TO OTHER SANITARY PRODUCTS AND SYSTEMS LIKE PLASTIC CISTERNS AND OTHER ACCESSORIES.

These systems are suitable for various applications and building types, including domestic, commercial, industrial and civil construction projects. Paling products are accurately designed to consistently exceed the performance aspects specified under widely recognized standards.

Along with ISO 9001 certification and various approvals by SIRIM and IKRAM, Paling products are accredited by NSF, an authority in water industry standards.

Paling products are manufactured under an effective system of inspection, testing, supervision and control.

ABOUT THE ALIAXIS GROUP

THE ALIAXIS GROUP IS A LEADING GLOBAL MANUFACTURER AND DISTRIBUTOR OF PRIMARY PLASTIC FLUID HANDLING SYSTEMS USED IN RESIDENTIAL AND COMMERCIAL CONSTRUCTION.



Aliaxis is present in more than 40 countries. The Group has more than 100 manufacturing and commercial entities and employs over 14,600 people.

The ethos of the Group allows local and global knowledge of the industry, regulations and building practices to combine and provide consistently excellent customer service to specifiers, consultants, contractors, installers and others.

IN ASIA

Malaysia:
Kuala Lumpur

Singapore

Vietnam:
Ho Chi Minh

China:
Beijing,
Shanghai &
Guangzhou

India:
Bangalore,
Mumbai & Goa

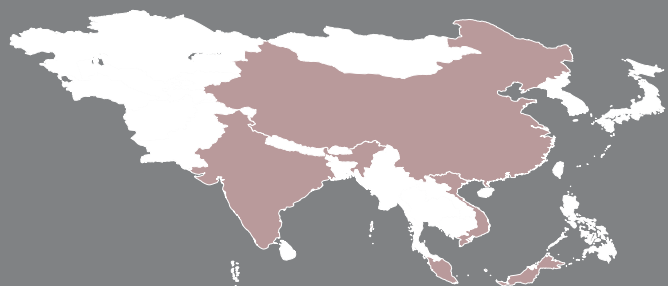

NOTE :

: DATE

NOTE :

: DATE

NOTE :

: DATE

PALING

SOIL, WASTE & VENT SYSTEM

an **Allaxis** company

LEAD-FREE
PIPE SYSTEMS

SUITABLE FOR BUILDINGS, HOUSES AND CIVIL CONSTRUCTION PURPOSES.

PALING

UNDERGROUND DRAINAGE & SEWER SYSTEM

an **Allaxis** company

LEAD-FREE
PIPE SYSTEMS

SUITABLE FOR BUILDINGS, HOUSES AND CIVIL CONSTRUCTION PURPOSES.

PALING

RAINWATER DRAINAGE SYSTEM

an **Allaxis** company

LEAD-FREE
PIPE SYSTEMS

SUITABLE FOR BUILDINGS, HOUSES AND CIVIL CONSTRUCTION PURPOSES.

PALING

HYDROTECH™ MS3
MULTI-LAYER PVC-U

an **Allaxis** company

LEAD-FREE
PIPE SYSTEMS

SUITABLE FOR BUILDINGS, HOUSES AND CIVIL CONSTRUCTION PURPOSES.

PALING

Elegance
RAINCUTTERS

an **Allaxis** company

LEAD-FREE
PIPE SYSTEMS

SUITABLE FOR BUILDINGS AND HOUSES

PALING

RAINWATER SYSTEM & GYROJOINT

an **Allaxis** company

LEAD-FREE
PIPE SYSTEMS

SUITABLE FOR CIVIL CONSTRUCTION PURPOSES AND BUILDING.

Disclaimer

This brochure has been compiled by Paling Industries Sdn Bhd ("the company") to promote better understanding of the technical aspects of the Company's products to assist users in obtaining from them the best possible performance. The brochure is supplied subject to acknowledgment of the following conditions:

- i) The brochure is protected by Copyright and may not be copied or reproduced in any form or by any means in whole or in part without prior consent in writing by the Company.
- ii) Product specifications, usage data and advisory information may change from time to time with advances in research and field experience. The Company reserves the right to make such changes at any time without notice.
- iii) Correct usage of the Company's products involve engineering judgements which cannot be properly made without full knowledge of all the conditions pertaining to each specific installation. The Company expressly disclaims all and any liability to any person done by any such person in reliance whether whole or partial upon the whole or any part of the contents of this brochure.
- iv) No offer to trade, nor any conditions of trading, are expressed or implied by the issue or content of this brochure.
- v) Nothing herein shall override the Company's conditions of Sale, which may be obtained from the Registered Office or any Sales Office of the Company.
- vi) This brochure is and shall remain the property of the Company, and shall surrendered on demand to the Company.



TRUSTED PIPEWORK FOR LIFE

